

Controls – Contactors and Contactor Assemblies



3/2	Introduction	3/78	3RH11 coupling relays for switching auxiliary circuits, 4-pole
	3RT, 3TB, 3TF Contactors for Switching Motors	3/79	3RT Coupling Relays 3RT10 coupling relays (interface), for switching motors, 3-pole, 3 ... 11 kW
3/5	General data		3TX7, 3RS18 Coupling Relays
3/11	3RT10 contactors, 3-pole, 3 ... 250 kW		<u>3TX7 Coupling Relays, Narrow Design</u>
3/27	3RT12 vacuum contactors, 3-pole, 110 ... 250 kW	3/82	Relay couplers
3/28	3TF6 vacuum contactors, 3-pole, 335 ... 450 kW	3/84	Relay couplers with plug-in connection
3/29	3TB5 contactors with DC solenoid system, 3-pole, 55 ... 200 kW	3/86	Semiconductor couplers
3/30	3TF2 contactors, 3-pole, 2.2 ... 4 kW		3RS18 Coupling Relays with <u>Industrial Housing</u>
	3RA13, 3RA14 Contactor Assemblies	3/88	Relay couplers
	<u>3RA13 Reversing Contactor Assemblies</u>		Coupling Relays with LZS/LZX Plug-In Relays
3/32	3RA13 complete units, 3 ... 45 kW	3/89	Plug-in relay couplers
3/37	Components for customer assembly		3TG10 Power Relays/ Miniature Contactors
	<u>3RA14 Contactor Assemblies for Wye-Delta Starting</u>	3/96	4-pole, 4 kW
3/40	3RA14 complete units, 3 ... 75 kW		Accessories and Spare Parts
3/47	Components for customer assembly		<u>For 3RT, 3RH Contactors and Contactor Relays</u>
	3TD, 3TE Contactor Assemblies	3/97	Accessories for 3RT, 3RH contactors and contactor relays
3/48	3TD6 reversing contactor assemblies, 335 kW	3/114	Spare parts for 3RT, 3RH contactors and contactor relays
3/49	3TE6 contactor assemblies for wye-delta starting, 630 kW		<u>For 3T Contactors and Contactor Relays</u>
	3RT, 3RH, 3TB, 3TC, 3TH, 3TK Contactors for Special Applications	3/119	Accessories for 3TB, 3TC, 3TF, 3TG, 3TK contactors
	<u>3RT14 Contactors for Switching Resistive Loads (AC-1)</u>	3/124	Accessories for 3TH contactor relays
3/50	3-pole, 140 ... 690 A	3/127	Spare parts for 3TB, 3TC, 3TF, 3TK contactors
	<u>3RT13 Contactors for Switching Resistive Loads (AC-1)</u>		
3/52	4-pole, 4 NO, 18 ... 140 A		
	<u>3TK1 Contactors for Switching Resistive Loads (AC-1)</u>		
3/54	4-pole, 4 NO, 200 ... 1000 A		
	<u>3TK20 Contactors</u>		
3/55	4-pole, 4 kW		
	<u>3RT15 Contactors</u>		
3/57	4-pole, 2 NO + 2 NC, 4 ... 18.5 kW		
	<u>3RT16 Capacitor Contactors</u>		
3/58	12.5 ... 50 kvar		
	<u>Contactors with Extended Operating Range $0.7 \dots 1.25 \times U_{s1}$ for Railway Applications</u>		
3/59	3RH11 contactor relays		
3/60	3TH4 contactor relays		
3/61	3RT10 motor contactors, 5.5 ... 45 kW		
3/64	3TB5 motor contactors, 55 ... 200 kW		
3/65	3TC contactors for switching DC voltage, 2-pole		
	<u>3TC Contactors for Switching DC Voltage</u>		
3/66	1- and 2-pole, 32 ... 400 A		
	3RH, 3TH Contactor Relays		
3/69	3RH1 contactor relays, 4- and 8-pole		
3/72	3RH14 latched contactor relays, 4-pole		
3/73	3TH4 contactor relays, 8- and 10-pole		
3/75	3TH2 contactor relays, 4- and 8-pole		

Note:
For safety characteristics for contactors see "Appendix" --> "Standards and Approvals" --> "Overview".

Controls – Contactors and Contactor Assemblies

Introduction

Overview



Size
Type

S00
3RT10 1

S0
3RT10 2

S2
3RT10 3

3RT10 contactors • 3RT12 and 3TF68/69 vacuum contactors

Type		3RT10 15	3RT10 16	3RT10 17	3RT10 23	3RT10 24	3RT10 25	3RT10 26	3RT10 34	3RT10 35	3RT10 36
AC, DC operation		(p. 3/15, 3/19)			(p. 3/16, 3/20)				(p. 3/17, 3/21)		
Type		--			--				--		
AC-3											
I_e /AC-3/400 V	A	7	9	12	9	12	17	25	32	40	50
400 V	kW	3	4	5.5	4	5.5	7.5	11	15	18.5	22
230 V	kW	2.2	3	3	3	3	4	5.5	7.5	11	15
500 V	kW	3.5	4.5	5.5	4.5	7.5	10	11	18.5	22	30
690 V	3RT10/12 kW	4	5.5	5.5	5.5	7.5	11	11	18.5	22	22
1 000 V	3RT10/12 kW	--	--	--	--	--	--	--	--	--	--
AC-4 (for $I_a = 6 \times I_e$)											
400 V	kW	3	4	4	4	5.5	7.5	7.5	15	18.5	22
400 V	3RT10/12 kW	1.15	2	2	2	2.6	3.5	4.4	8.2	9.5	12.6
(200 000 operating cycles)											
AC-1 (40 °C, ≤ 690 V)											
I_e	3RT10/12 A	18	22	22	40	40	40	40	50	60	60

3RT14 AC-1 contactors

Type		--		--		--
I_e /AC-1/40 °C ≤ 690 V	A	--		--		--

Accessories for contactors

Auxiliary switch blocks	front lateral	3RH19 11	(p. 3/100)	3RH19 21	(p. 3/100)	3RH19 21	(p. 3/103)
Terminal covers		--		--		3RT19 36-4EA2	(p. 3/112)
Box terminal blocks		--		--		--	
Surge suppressors		3RT19 16	(p. 3/107)	3RT19 26	(p. 3/107)	3RT19 26/36	(p. 3/107)

3RU1 and 3RB2 overload relays (Protection Equipment --> Overload Relays)

3RU11 , thermal, CLASS 10	3RU11 16	0.1 ... 12 A (Chap. 5)	3RU11 26	1.8 ... 25 A (Chap. 5)	3RU11 36	5.5 ... 50 A (Chap. 5)
3RB20/21 , solid-state, CLASS 5, 10, 20 and 30	3RB20 16 3RB21 16	0.1 ... 12 A (Chap. 5)	3RB20 26 3RB21 26	3 ... 25 A (Chap. 5)	3RB20 36 3RB21 36	6 ... 50 A (Chap. 5)
3RB22/23 , solid-state, CLASS 5, 10, 20 and 30	3RB2. 83 + 3RB29 06 0.3 ... 25 A (Chap. 5)		3RB2. 83 + 3RB29 06 10 ... 100 A (Chap. 5)			

3RV10 motor starter protectors (Protection Equipment --> Motor Starter Protectors)

Type	3RV10 11	0.18 ... 12 A (Chap. 5)	3RV10 21	9 ... 25 A (Chap. 5)	3RV10 31	22 ... 50 A (Chap. 5)
Link modules	3RA19 11	(Chap. 5)	3RA19 21	(Chap. 5)	3RA19 31	(Chap. 5)

3RA13 reversing contactor assemblies

Complete units	Type	3RA13 15	3RA13 16	3RA13 17	3RA13 24	3RA13 25	3RA13 26	3RA13 34	3RA13 35	3RA13 36
		(p. 3/33)			(p. 3/34)			(p. 3/35)		
400 V	kW	3	4	5.5	5.5	7.5	11	15	18.5	22
Assembly kits/wiring modules		3RA19 13-2A			3RA19 23-2A			3RA19 33-2A		
		(p. 3/38)			(p. 3/38)			(p. 3/38)		
Mechanical interlocks		3RA19 12-2H			3RA19 24-1A/-2B					
		(p. 3/39)			(p. 3/37)					

3RA14 contactor assemblies for wye-delta starting

Complete units	Type	3RA14 15	3RA14 16	3RA14 23	3RA14 25	3RA14 34	3RA14 35	3RA14 36
		(p. 3/42)		(p. 3/43)		(p. 3/44)	(p. 3/45)	
400 V	kW	5.5	7.5	11	15/18.5	22/30	37	45
Assembly kits/wiring modules		3RA19 13-2B		3RA19 23-2B	3RA19 25-2B	3RA19 33-2B/-2C		3RA19 36-2B
		(p. 3/47)		(p. 3/47)	(p. 3/47)	(p. 3/47)		(p. 3/47)

Note:

For safety characteristics for contactors see "Appendix" --> "Standards and Approvals" --> "Overview".



S3
3RT1. 4



S6
3RT1. 5



S10
3RT1. 6



S12
3RT1. 7



S14
3TF6

3RT10 44 (p. 3/18, 3/21)	3RT10 45	3RT10 46	3RT10 54 (p. 3/23)	3RT10 55	3RT10 56	3RT10 64 (p. 3/23)	3RT10 65	3RT10 66	3RT10 75 (p. 3/23)	3RT10 76	--		
--			--			3RT12 64 (p. 3/27)	3RT12 65	3RT12 66	3RT12 75 (p. 3/27)	3RT12 76	3TF68 (p. 3/27)	3TF69	
65	80	95	115	150	185	225	265	300	400	500	630	820	
30	37	45	55	75	90	110	132	160	200	250	335	450	
18.5	22	22	37	45	55	55	75	90	132	160	200	260	
37	45	55	75	90	110	160	160	200	250	355	434	600	
45	55	55	110	132	160	200	250	250	400	400/500	600	800	
30	37	37	75	90	90	90/315	132/355	132/400	250/560	250/710	600	800	
30	37	45	55	75	90	110	132	160	200	250	355	400	
15.1	17.9	22	29	38	45	54/78	66/93	71/112	84/140	98/161	168	191	
100	120	120	160	185	215	275/330	330	330	430/610	610	700	910	
3RT14 46		(p. 3/50)	3RT14 56		(p. 3/51)	3RT14 66		(p. 3/51)	3RT14 76		(p. 3/51)	--	
140			275			400			690			--	
													--
													3TY7 561
													(p. 3/120)
3RT19 46-4EA1/2		(p. 3/112)	3RT19 56-4EA1/2/3		(p. 3/112)	3RT19 66-4EA1/2/3		(p. 3/112)	3RT19 76		(p. 3/112)	3TX7 686/696	
--			3RT19 55/56-4G		(p. 3/112)	3RT19 66-4G		(p. 3/112)				--	(p. 3/120)
			3RT19 56-1C		(RC element) (p. 3/108)							3TX7 572	(p. 3/119)
3RU11 46	18 ... 100 A	(Chap. 5)	--			--			--				--
3RB20 46	12.5 ... 100 A	(Chap. 5)	3RB20 56	50 ... 200 A	(Chap. 5)	3RB20 66	55 ... 630 A	(Chap. 5)	3RB20 66	160 ... 630 A	3RB20 66	160 ... 630 A	3RB20 66
3RB21 46			3RB21 56			3RB21 66			3RB21 66		3RB21 66		(Chap. 5)
			3RB2. 83 + 3RB29 56	20 ... 200 A	(Chap. 5)	3RB2. 83 + 3RB29 66	63 ... 630 A	(Chap. 5)					
3RV10 41	45 ... 100 A	(Chap. 5)	--			--			--				--
3RA19 41		(Chap. 5)	--			--			--				--
3RA13 44	3RA13 45	3RA13 46	--			--			--				3TD68 04
(p. 3/36)													(p. 3/48)
30	37	45	55	75	90	110	132	160	200	250	335		
3RA19 43-2A		(p. 3/38)	3RA19 53-2A		(p. 3/38)	3RA19 63-2A		(p. 3/38)	3RA19 73-2A		(p. 3/38)	3TX7 680-1A	
			3RA19 54-2A		(p. 3/37)							3TX7 686-1A	
3RA14 44	3RA14 45		--			--			--				3TE68 04
(p. 3/46)													(p. 3/48)
55	75		--			--			--				630
3RA19 43-2B/-2C		(p. 3/47)	3RA19 53-2B		(p. 3/47)	3RA19 63-2B		(p. 3/47)	3RA19 73-2B		(p. 3/47)	3TX7 680-1B	

Controls – Contactors and Contactor Assemblies

Introduction

The advantages at a glance



3TX7



3RS18



LZS/LZX



3TG10

	Order No.	Page
Coupling links, narrow design		
Relay couplers	<ul style="list-style-type: none"> Width 6.2 mm (1 NO, 1 CO), 12.5 mm and 17.5 mm Output coupling links Input coupling links with hard gold-plating 	3TX7 002, 3TX7 003, 3TX7 004, 3TX7 005
Plug-in base couplers, complete with relay	<ul style="list-style-type: none"> Width 6.2 mm (1 NO, 1 CO) Relays, replaceable 	3TX7 014-1..00
Plug-in base couplers, complete with relay and hard gold-plating	<ul style="list-style-type: none"> Width 6.2 mm (1 CO) 	3TX7 014-1..02
Semiconductor couplers	<ul style="list-style-type: none"> Output 1 semiconductor, triac or transistor 	3TX7 002, 3TX7 004, 3TX7 005
Coupling relays in industrial housing		
Relay couplers	<ul style="list-style-type: none"> Protective separation up to 300 V between contacts and relay circuits 1, 2 and 3 changeover contacts Hard gold-plated contacts in combination and wide voltage range versions 	3RS18
Coupling relays with plug-in relays		
Plug-in relay couplers with 2, 3 and 4 changeover contacts	<ul style="list-style-type: none"> Switching capacity 12 A/10 A/6 A Width 27 mm Base optionally with or without logical isolation 	LZS/LZX:PT
Plug-in relay couplers with 3 changeover contacts and circular base	<ul style="list-style-type: none"> Switching capacity 6 A 11-pole circular base Width 38 mm 	LZS/LZX:MT
Plug-in relay couplers with 1, 2 changeover contacts	<ul style="list-style-type: none"> Switching capacity 16 A/8 A Width 15.5 mm Base optionally with or without logical isolation 	LZS/LZX:RT
Power relays/miniature contactors		
With screw and flat connectors		3TG10

Connection methods

The contactors and relays are available with screw terminals (box terminals and connecting bars) or with Cage Clamp terminals or spring-type terminals. Some device types are also available with plug-type connectors.



Screw terminals



Cage Clamp terminals or spring-type terminals



Flat connectors



Plug-in terminals



Solder pin connections

The terminals are indicated in the selection and ordering data by orange backgrounds.

Overview

3RT1 contactors and coupling relays
Size S00 with mountable accessories

The SIRIUS generation of controls is a complete, modular system family, logically designed right down to the last detail, from the basic units to the accessories.

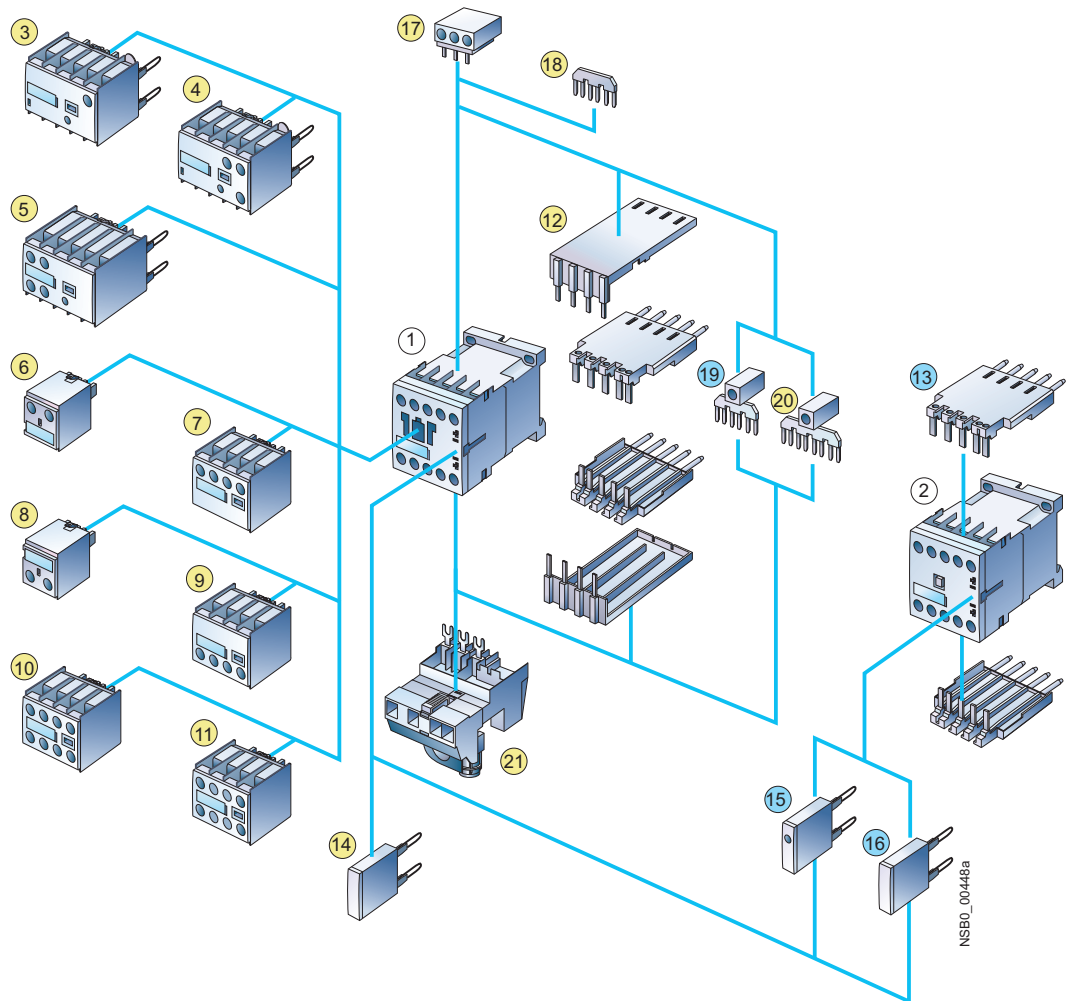

- ① Contactor (page 3/15)
- ② Coupling relay (page 3/79)

- ③ Solid-state time-delay block, ON-delay (page 3/106)
- ④ Solid-state time-delay block, OFF-delay (page 3/106)
- ⑤ Auxiliary switch block with solid-state time delay (page 3/105)
(ON or OFF-delay or wye-delta function)
- ⑥ 1-pole auxiliary switch block, cable entry from above (page 3/100)
- ⑦ 2-pole auxiliary switch block, cable entry from above (page 3/100)
- ⑧ 1-pole auxiliary switch block, cable entry from below (page 3/100)
- ⑨ 2-pole auxiliary switch block, cable entry from below (page 3/100)
- ⑩ 4-pole auxiliary switch block (page 3/100) (terminal designations according to EN 50012 or EN 50005)
- ⑪ 2-pole auxiliary switch block, standard version or solid-state compatible version (pages 3/100, 3/105)
(terminal designations according to EN 50005)
- ⑫ Solder pin adapter for contactors with 4-pole auxiliary switch block (page 3/111)
- ⑬ Solder pin adapter for contactors and coupling relays (page 3/110)

- ⑭ Additional load module for increasing the permissible residual current (page 3/109)
- ⑮ Surge suppressor with LED (page 3/108)
- ⑯ Surge suppressor without LED (page 3/108)
- ⑰ 3-phase feeder terminal (page 3/47)
- ⑱ Link for paralleling (star jumper), 3-pole, without connection terminal (page 3/47)
- ⑲ Link for paralleling, 3-pole, with terminal (page 3/111)
- ⑳ Link for paralleling, 4-pole, with terminal (page 3/111)
- ㉑ Connection module (adapter and plug) for contactors with screw-type connection (page 3/110)

- For contactors
- For contactors and coupling relays (interface)

For contactor assemblies see pages 3/32 to 3/39.
For assembly kit for reversing contactor assemblies (mech. interlocking, wiring modules) see page 3/38.
For mountable overload relays see "Protection Equipment --> Overload Relays".

For fuseless load feeders, see "Load Feeders, Motor Starters and Soft Starters -> 3RA Fuseless Load Feeders".

3RT, 3TB, 3TF Contactors for Switching Motors

General data

3RT1 contactors

Sizes S0 to S3 with mountable accessories

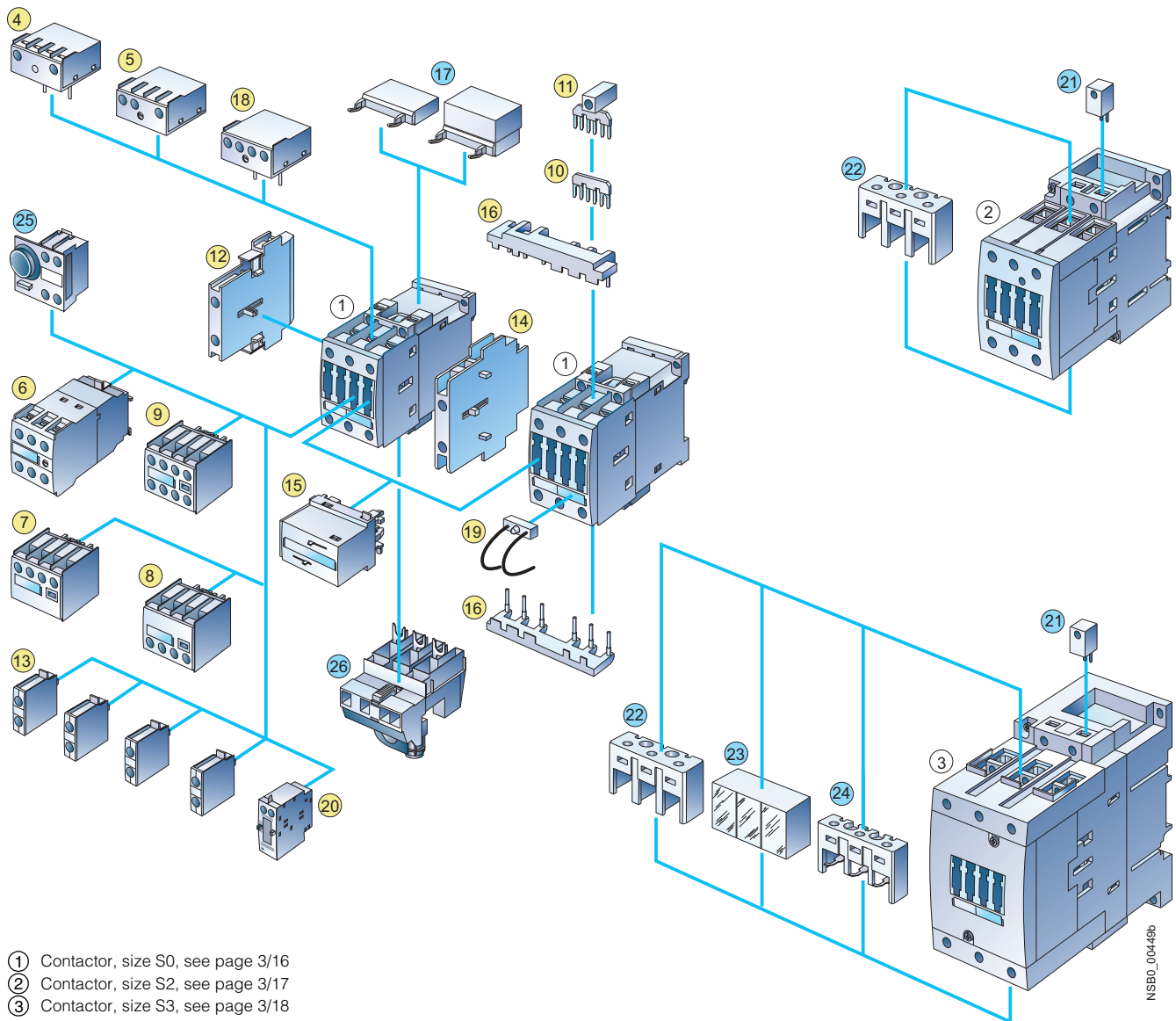

NSB0_00449b

- ① Contactor, size S0, see page 3/16
- ② Contactor, size S2, see page 3/17
- ③ Contactor, size S3, see page 3/18

For sizes S0 to S3:

- ④ Solid-state time-delay block, ON-delay (page 3/106)
- ⑤ Solid-state time-delay block, OFF-delay (page 3/106)
- ⑥ Auxiliary switch block with solid-state time delay (page 3/105) (ON or OFF-delay or wye-delta function)
- ⑦ 2-pole auxiliary switch block, cable entry from above (page 3/101)
- ⑧ 2-pole auxiliary switch block, cable entry from below (page 3/101)
- ⑨ 4-pole auxiliary switch block (page 3/101) (terminal designations according to EN 50012 or EN 50005)
- ⑩ Link for paralleling (star jumper), 3-pole, without connection terminal (page 3/47)
- ⑪ Link for paralleling, 3-pole, with terminal (page 3/111)
- ⑫ 2-pole auxiliary switch block, laterally mountable left or right (page 3/103) (terminal designations according to EN 50012 or EN 50005)
- ⑬ Single-pole auxiliary switch block (up to 4 can be snapped on) (page 3/101)
- ⑭ Mechanical interlock, laterally mountable (page 3/37)
- ⑮ Mechanical interlock, mountable on the front (page 3/37)
- ⑯ Wiring modules on the top and bottom (reversing duty) (page 3/39)
- ⑰ Surge suppressor (page 3/107) (varistor, RC element, diode assembly), can be mounted on the top or bottom (different for S0 and S2/S3)

- ⑱ Coupling link for mounting directly onto contactor coil (page 3/110)
- ⑲ LED module for indicating contactor operation (page 3/110)

Only for size S0:

- ⑳ Pneumatic delay block (page 3/106)
- ㉑ Connection module (adapter and plug) for contactors with screw-type connection (page 3/110)

Only for sizes S0 and S2:

- ㉒ Mechanical latching (page 3/106)

Only for sizes S2 and S3:

- ㉓ Coil repeat terminal for making contactor assemblies (page 3/37)
- ㉔ Terminal cover for box terminals (page 3/112)

Only for size S3:

- ㉕ Terminal cover for cable lugs and busbar connections (page 3/112)
- ㉖ Auxiliary conductor terminal, 3-pole (page 3/110)

- Accessories identical for sizes S0 to S3
- Accessories differ according to size

3RT1 contactors
Sizes S6 to S12 with accessories
(illustration for basic unit)

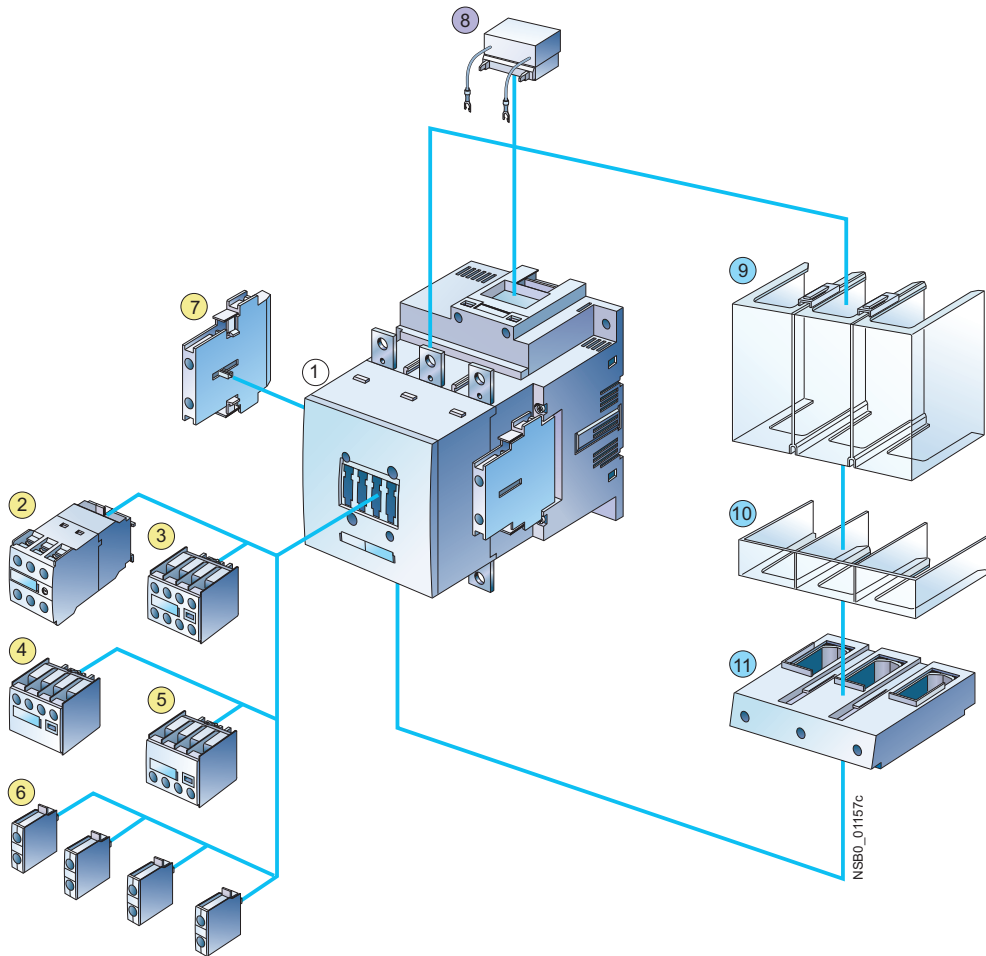

① 3RT10 and 3RT14 air-break contactor, sizes S6, S10 and S12
 (page 3/23 and 3/51)

- ② Auxiliary switch block with solid-state time delay (page 3/105)
 (ON or OFF-delay or wye-delta function)
- ③ 4-pole auxiliary switch block (page 3/100)
 (terminal designations according to EN 50012 or EN 50005)
- ④ 2-pole auxiliary switch block, cable entry from above (page 3/101)
- ⑤ 2-pole auxiliary switch block, cable entry from below (page 3/101)
- ⑥ Single-pole auxiliary switch block (up to 4 can be snapped on)
 (page 3/101)
- ⑦ 2-pole auxiliary switch block, laterally mountable left or right (page 3/103)
 (terminal designations according to EN 50012 or EN 50005)
 (identical for S0 to S12)
- ⑧ Surge suppressor (RC element) (page 3/108), for plugging into top of
 withdrawable coil

- ⑨ Terminal cover for cable lug and busbar connection
 (page 3/112), different for sizes S6 and S10/S12
- ⑩ Terminal cover for box terminal, (page 3/112),
 different for sizes S6 and S10/S12
- ⑪ Box terminal block (page 3/112), different for sizes S6 and S10/S12

- Accessories identical for sizes S0 to S12
- Accessories identical for sizes S6 to S12
- Accessories differ according to size

For mountable overload relays see "Protection Equipment -->
 Overload Relays".

3RT, 3TB, 3TF Contactors for Switching Motors

General data

3RA1 contactor assemblies, 3RT1 contactors
Size S6 with accessories

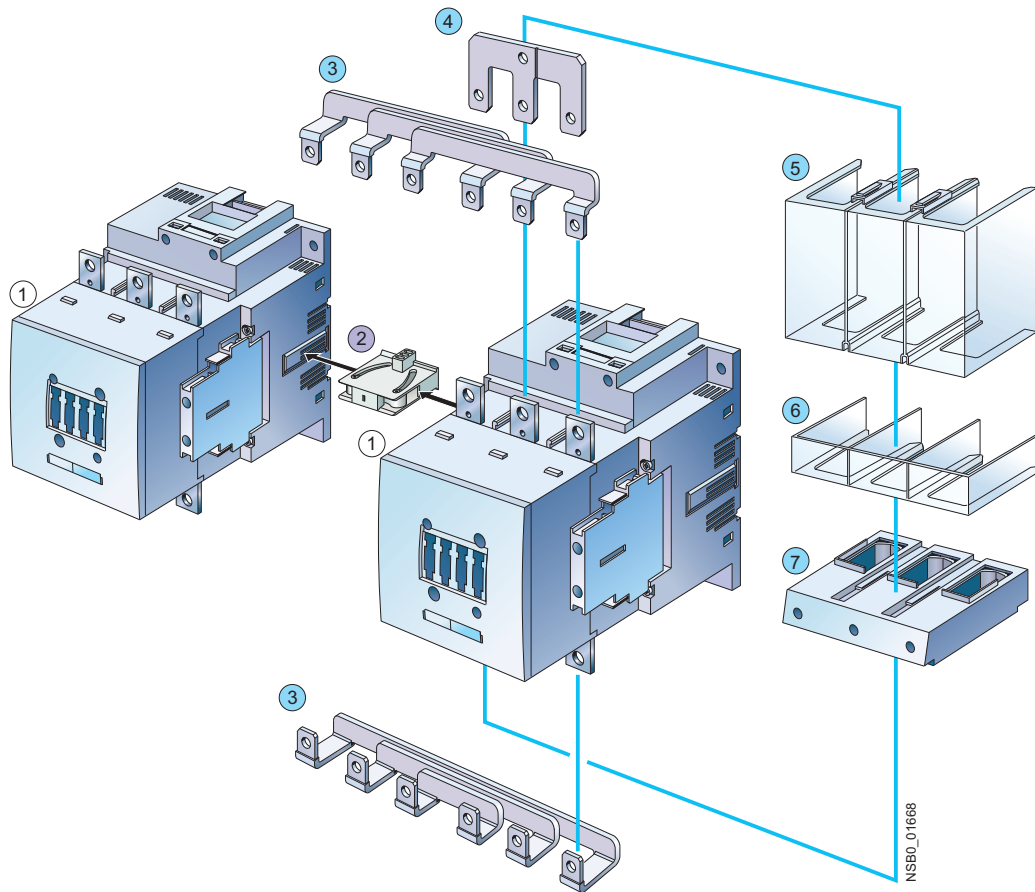

① 3RT10 and 3RT14 air-break contactor, size S6 (page 3/23 and 3/51)

② 3RA19 54-2A mechanical interlock, laterally mountable (page 3/37)

③ 3RA19 53-2A wiring modules on the top and bottom (page 3/39)

④ 3RT19 56-4BA31 link for paralleling (star jumper), 3-pole, with through-hole (page 3/111)

⑤ Terminal cover for cable lug and busbar connection (page 3/112), different for sizes S6 and S10/S12

⑥ Terminal cover for box terminal, (page 3/112), different for sizes S6 and S10/S12

⑦ Box terminal block (page 3/112), different for sizes S6 and S10/S12

● Accessories identical for sizes S6 to S12

● Accessories differ according to size

For mountable overload relays see "Protection Equipment --> Overload Relays".

3RA1 contactor assemblies, 3RT1 contactors
Sizes S6, S10 and S12 with accessories

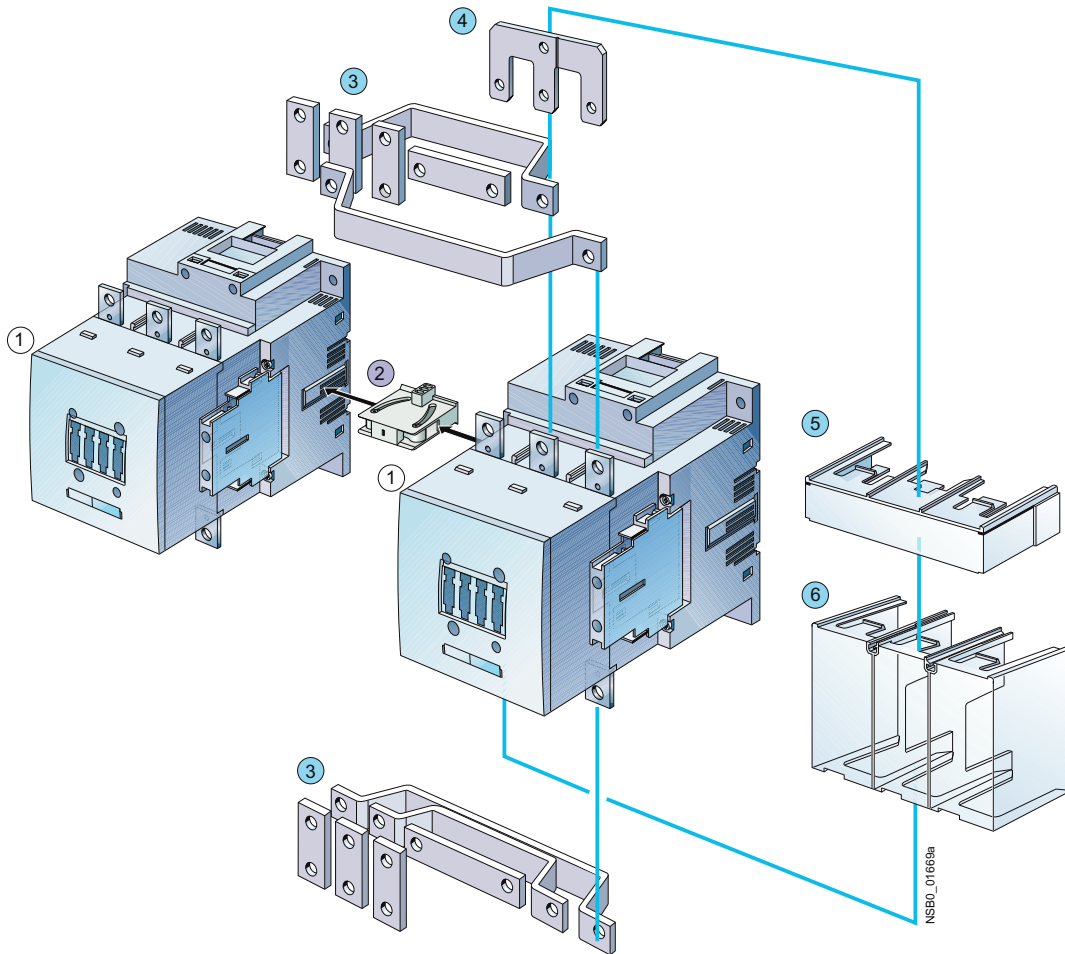

① 3RT10 and 3RT14 air-break contactor, sizes S6, S10 and S12
 (page 3/23 and 3/51) or
 3RT12 vacuum contactor, sizes S10 and S12 (page 3/27)

② Mechanical interlock, laterally mountable (page 3/37)

③ 3RA19 wiring modules on the top and bottom (page 3/38)

④ 3RT19 56-4BA31 link for paralleling (star jumper), 3-pole,
 with through-hole (page 3/111)

⑤ Terminal cover for box terminal, (page 3/112),
 different for sizes S6 and S10/S12

⑥ Terminal cover for cable lug and busbar connection (page 3/112),
 different for sizes S6 and S10/S12

● Accessories identical for sizes S6 to S12

● Accessories differ according to size

For mountable overload relays see "Protection Equipment -->
 Overload Relays".

3RT, 3TB, 3TF Contactors for Switching Motors

General data

3RT1 contactors Sizes S6 to S12 with accessories

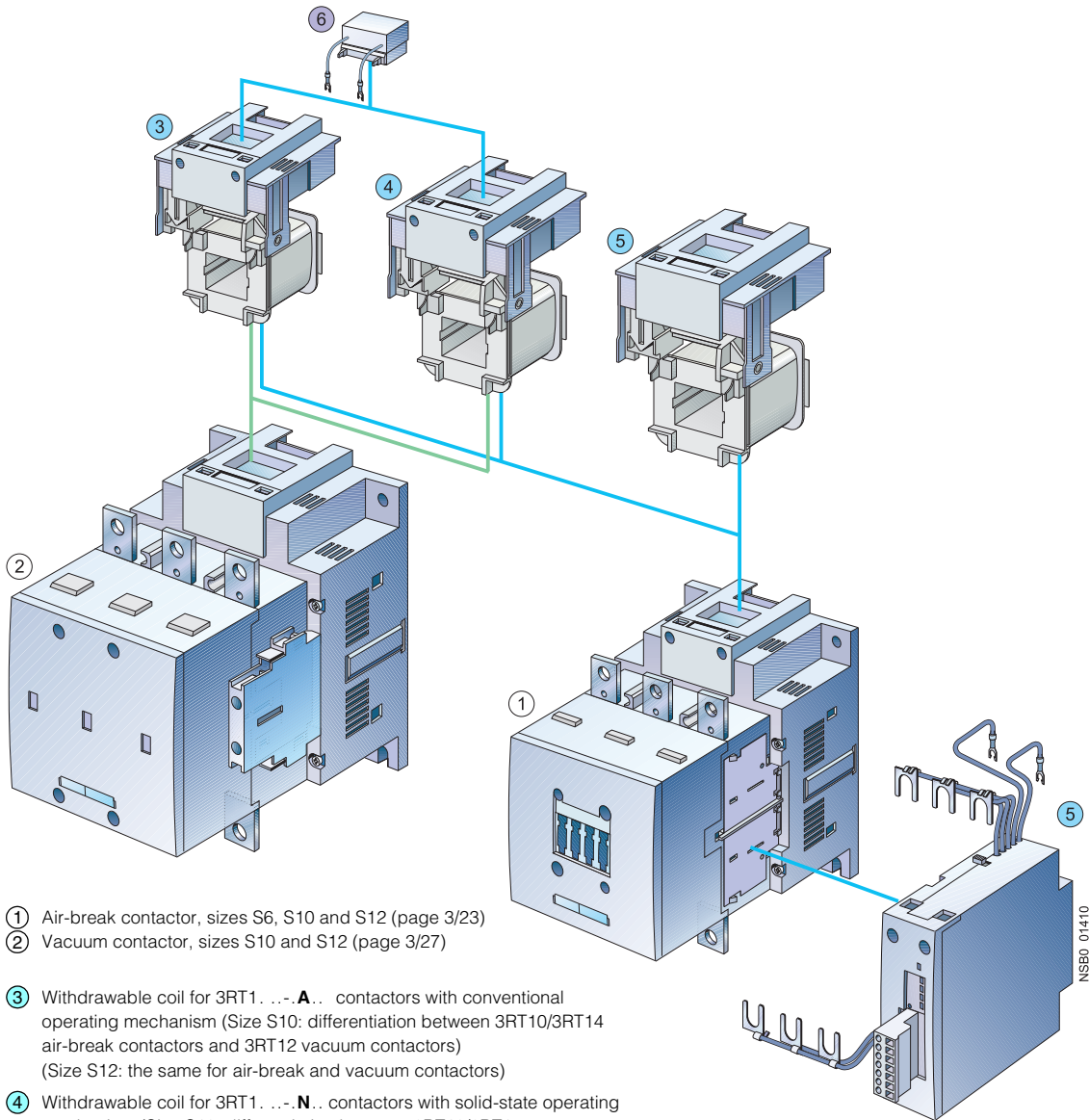

- ① Air-break contactor, sizes S6, S10 and S12 (page 3/23)
 ② Vacuum contactor, sizes S10 and S12 (page 3/27)
- ③ Withdrawable coil for 3RT1...-**A**.. contactors with conventional operating mechanism (Size S10: differentiation between 3RT10/3RT14 air-break contactors and 3RT12 vacuum contactors) (Size S12: the same for air-break and vacuum contactors)
- ④ Withdrawable coil for 3RT1...-**N**.. contactors with solid-state operating mechanism (Size S10: differentiation between 3RT10/3RT14 air-break contactors and 3RT12 vacuum contactors) (Size S12: the same for air-break and vacuum contactors)
- ⑤ Withdrawable coil and laterally mountable module (plug-on) for 3RT1...-**P**.. and 3RT1...-**Q**.. air-break contactors with solid-state operating mechanism and remaining lifetime indicator.
- ⑥ Surge suppressor (RC element) (page 3/107), plug-mountable on withdrawable coils
- 3RT1...-**A**..with conventional operating mechanism
 - 3RT1...-**N**.. with solid-state operating mechanism

- ① Identical for sizes S6 to S12
 ② Different according to size

For mountable overload relays see "Protection Equipment --> Overload Relays".

NSB0_01410

Overview

3RT10 contactors, 3-pole, sizes S00 to S3, up to 45 kW

AC and DC operation

IEC 60947, EN 60947 (VDE 0660)

The 3RT1 contactors are climate-proof. They are finger-safe according to EN 50274.

Size S00 contactors have an auxiliary contact integrated in the basic unit. The basic units of sizes S0 to S3 contain only the main current paths.

All basic units can be extended with auxiliary switch blocks. For size S0 and higher, complete units with 2 NO + 2 NC are available (connection designation according to EN 50012). The auxiliary switch block can be removed (for more information see [Technical Information LV 1 T](#)).

In addition, complete units with permanently mounted auxiliary switch block (2 NO + 2 NC according to EN 50012) are offered for sizes S00 and S0. These versions are built according to special Swiss regulations "SUVA" and are distinguished externally by a red labeling plate.

Connection methods

The 3RT1 contactors are available with screw terminals (box terminals and connecting bars) or with Cage Clamp terminals.

The size S3 contactors have removable box terminals for the main conductor connections. This permits connection of ring terminal lugs or busbars.

Contact reliability

If voltages ≤ 110 V and current ≤ 100 mA are to be switched, the auxiliary contacts of the 3RT1 contactor or 3RH11 contactor relay should be used as they guarantee a high level of contact reliability.

These auxiliary contacts are suitable for solid-state circuits with currents ≥ 1 mA at a voltage of 17 V.

Short-circuit protection of the contactors

For more information about short-circuit protection of contactors without overload relay, see [Technical specifications](#). For short-circuit protection of the contactors with overload relay, see ["Overload Relays"](#). To assemble fuseless motor feeders you must select combinations of motor starter protector and contactor as explained in ["Fuseless Load Feeders"](#).

Motor protection

3RU11 thermal overload relays or 3RB20 solid-state overload relays can be fitted to the 3RT1 contactors for protection against overload. The overload relays must be ordered separately.

Ratings of induction motors

The quoted rating (in kW) refers to the output power on the motor shaft (according to the nameplate).

Surge suppression

3RT1 contactors can be retrofitted with RC elements, varistors, diodes or diode assemblies (assembly of diode and Zener diode for short break times) for damping opening surges in the coil.

The surge suppressors are plugged onto the front of size S00 contactors. Space is provided for them next to a snap-on auxiliary switch block.

For size S0 to S3 contactors, varistors and RC elements can be snapped on either on the top or directly below the coil terminals. Diode assemblies are available in 2 different versions on account of their polarity. Depending on the application they can be connected either only at the bottom (assembly with motor starter protector) or only at the top (assembly with overload relay).

The plug-in direction of the diodes and diode assemblies is specified by coding.

Exceptions:

3RT19 26-1T.00 and

3RT19 36-1T.00, in this case the plug-in direction is marked with "+" and "-".

Coupling relays are supplied either without surge suppression or with a varistor or diode connected as standard, according to the version.

Note:

The OFF-delay times of the NO contacts and the ON-delay times of the NC contacts increase if the contactor coils are damped against voltage peaks (noise suppression diode 6 to 10 times; diode assemblies 2 to 6 times, varistor +2 to 5 ms).

3RT10 contactors, 3-pole, sizes S6 to S12, > 45 to 250 kW

- 3RT10, contactors for switching motors,
- 3RT12, vacuum contactors for switching motors,
- 3RT14, contactors for AC-1 applications.

Operating mechanism types

Two types of solenoid operation are available:

- Conventional operating mechanism
- Solid-state operating mechanism (with 3 performance levels)

AC/DC operation

The contactors can be operated with AC (40 to 60 Hz) as well as with DC.

Withdrawable coils

For simple coil replacement, e. g. if the application is replaced, the solenoid coil can be pulled out upwards after the release mechanism has been actuated and can be replaced by any other coil of the same size.

Auxiliary contact complement

For details of the auxiliary switch fittings per S0-S12 contactor see [Technical Information LV1 T 2009, page 3/16](#).

- 3RT10 and 3RT14 contactors:
Auxiliary contacts mounted laterally and on front
- 3RT12 vacuum contactors:
Auxiliary contacts mounted laterally

Note:

Auxiliary contact complement according to SUVA.

Contactors with permanently mounted auxiliary switch block for safety applications according to SUVA

Contactors with conventional operating mechanism

3RT1. ...-A version:

The solenoid coil is switched directly on and off with the control supply voltage U_s by way of terminals A1/A2.

Multi-voltage range for the control supply voltage U_s :

Several closely adjacent control supply voltages, available around the world, are covered by just one coil, for example 110-115-120-127 V AC/DC or 220-230-240 V AC/DC.

In addition, allowance is also made for a coil operating range of 0.8 times the lower ($U_{s \min}$) and 1.1 times the upper ($U_{s \max}$) rated control supply voltage within which the contactor switches reliably and no thermal overloading occurs.

3RT, 3TB, 3TF Contactors for Switching Motors

3RT10 contactors, 3-pole, 3 ... 250 kW

Contactors with solid-state operating mechanism

The solenoid coil is supplied selectively with the power required for reliable switching and holding by upstream control electronics.

- **Wide voltage range for the control supply voltage U_s :**
Compared with the conventional operating mechanism, the solid-state operating mechanism covers an even broader range of control supply voltages used worldwide within one coil variant. For example, the coil for 200 to 277 V UC ($U_{s \min}$ to $U_{s \max}$) covers the voltages 200-208-220-230-240-254-277 V used worldwide.
- **Extended operating range 0.7 to 1.25 x U_s :**
The wide range for the rated control supply voltage and the additionally allowed coil operating range of $0.8 \times U_{s \min}$ to $1.1 \times U_{s \max}$ results in an extended coil operating range of at least 0.7 to $1.25 \times U_s$, within which the contactors will operate reliably, for the most common control supply voltages of 24, 110 and 230 V.
- **Bridging temporary voltage dips:**
Control voltage failures dipping to 0 V (at A1/A2) are bridged for up to approx. 25 ms to avoid unintentional tripping.
- **Defined ON and OFF thresholds:**
For voltages of $\geq 0.8 \times U_{s \min}$ and higher the electronics will reliably switch the contactor ON, and as of $\leq 0.5 \times U_{s \min}$ it is reliably switched OFF. The hysteresis in the switching thresholds prevents the main contacts from chattering as well as increased wear or welding when operated in weak, unstable networks. This also prevents thermal overloading of the contactor coil if the voltage applied is too low (contactor does not close properly and is continuously operated with overexcitation).
- **Low control power consumption when closing and in the closed state.**

Electromagnetic compatibility (EMC)

The contactors with solid-state operating mechanism comply with the requirements for operation in industrial plants.

- Interference immunity
 - Burst (IEC 61000-4-4): 4 kV
 - Surge (IEC 61000-4-5): 4 kV
 - Electrostatic discharge, ESD (IEC 61000-4-2): 8/15 kV
 - Electromagnetic field (IEC 61000-4-3): 10 V/m
- Emitted interference
 - Limit value class A according to EN 55011

Note:

In connection with converters, the control cables should be installed separately from the load cables of the converter.

Remaining lifetime indicator (RLT)

Main contactor contacts are working parts which must be replaced in good time when the end of their service life has been reached. The degree of contact erosion and thus the electrical endurance (= number of operating cycles) depends on the loading, utilization category, operating mode, etc. Up to now, routine checks/visual inspections by the maintenance personnel were needed in order to gain an insight into the state of the main contacts. The indication of remaining lifetime function now takes over this task. It does not count the number of operating cycles – which does not provide information about contact erosion – but instead electronically identifies, evaluates and stores the actual progress of erosion of each one of the three main contacts, and outputs a warning when specified limits are reached. The stored data are not lost even if the control supply voltage for A1/A2 fails. After replacement of the main contacts, measurement the remaining lifetime must be reset using the "RESET" button (hold down RESET button for about 2 seconds using a pen or similar tool).

Advantages:

- Signaling through relay contact or AS-i when remaining lifetime is 20 %, i.e. contact material wear is 80 %
- Additional visual indication of various levels of erosion by means of LEDs on the laterally mounted solid-state module when remaining lifetime is 60 % (green), 40 % (orange) and 20 % (red)

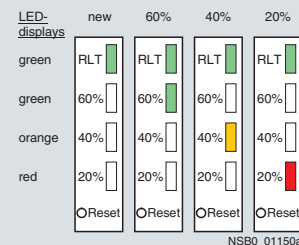

- Early warning to replace contacts
- Optimum utilization of contact material
- Visual inspection of the condition of contacts no longer necessary
- Reduction of ongoing operating costs
- Optimum planning of maintenance measures
- Avoidance of unforeseen plant downtimes

3RT1...-N version: for 24 V DC PLC output

2 control options:

- Control without a coupling link directly through a 24 V DC ≥ 30 mA PLC output (EN 61131-2). Connection by means of 2-pole plug-in connection. The screwless spring-type connection is part of the scope of supply. The control supply voltage which supplies the solenoid operating mechanism must be connected to A1/A2.

Note:

Before start-up, the slide switch for PLC operation must be moved to the "PLC ON" position (setting ex works: "PLC OFF").

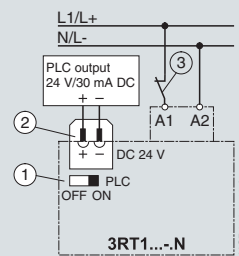

- Conventional control by applying the control supply voltage at A1/A2 through a switching contact.

Note:

The slide switch must be in the "PLC OFF" position (= setting ex works).

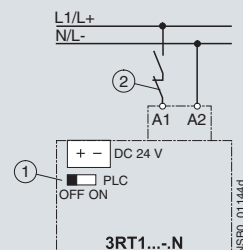

3RT, 3TB, 3TF Contactors for Switching Motors

3RT10 contactors, 3-pole, 3 ... 250 kW

3RT1...-P version: For 24 V DC PLC output or PLC relay output, with remaining lifetime indicator (RLT).

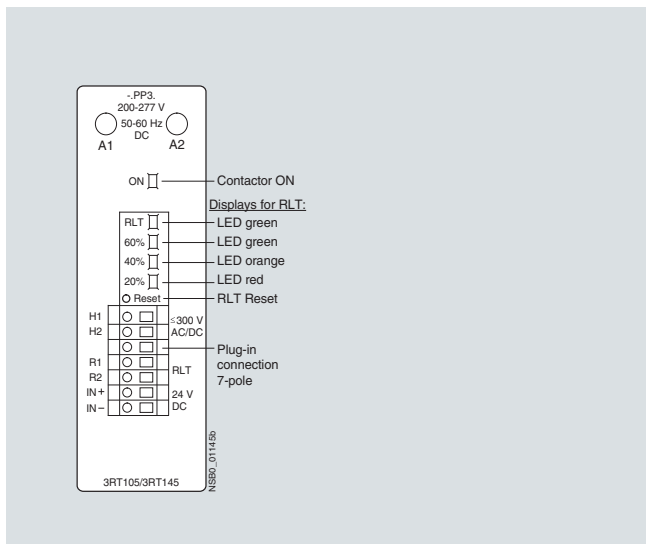

To supply the solenoid and the remaining lifetime indicator with power, the control supply voltage U_s must be connected to terminals A1/A2 of the laterally mounted solid-state module. The control inputs of the contactor are connected to a 7-pole plug-in connection; the screwless spring-operated connector is part of the scope of supply.

- The "Remaining Lifetime RLT" status signal is available at terminals R1/R2 through a floating relay contact (hard gold-plated, enclosed) and can be input to SIMOCODE, PLC or other devices for processing, for example. Permissible current-carrying capacity of the R1/R2 relay output:
 - I_e/AC -15/24 to 230 V: 3 A
 - I_e/DC -13/24 V: 1 A
- LED indications
The following states are indicated by means of LEDs on the laterally mounted solid-state module:
 - Contactor ON (energized state): Green LED ("ON")
 - Indication of remaining lifetime

2 control options:

- Contactor control without a coupling link directly through a 24 V DC ≥ 30 mA PLC output (EN 61131-2) by way of terminals IN+/IN-.

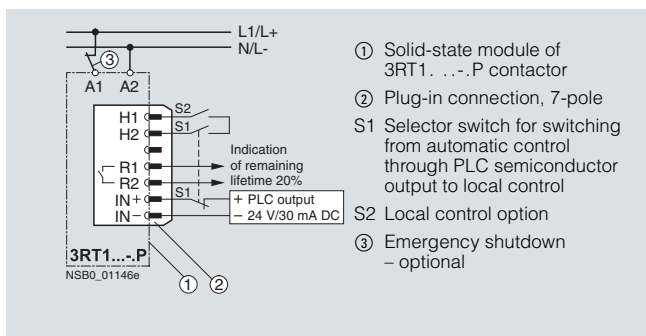

Possibility of switching from automatic control to local control by way of terminals H1/H2, i. e. automatic control through PLC or SIMOCODE/PROFIBUS DP can be deactivated e. g. at start-up or in the event of a fault and the contactor can be controlled manually.

- Contactor control through relay outputs, e. g. by
 - PLC
 - SIMOCODE
- by way of terminals H1/H2. Contact loading: U_s /approx. 5 mA. When operated through SIMOCODE, a communication link to PROFIBUS DP is also provided.

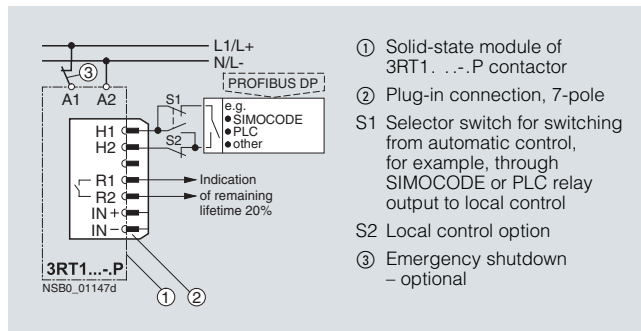

3RT1...-Q version: Communication-capable with integrated AS-Interface and indication of remaining lifetime (RLT)

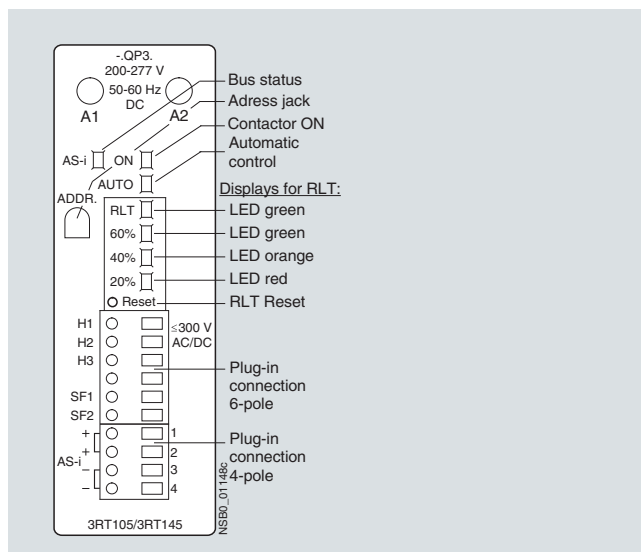

To supply the solenoid and the remaining lifetime indicator with power, the control supply voltage U_s must be connected to terminals A1/A2 of the laterally mounted solid-state module. The contactor itself is controlled by way of the integrated AS-Interface interface. The inputs and outputs are connected to a 10-pole plug-in connection; the screwless spring-type connections (6-pole for external connection and 4-pole for AS-Interface connection) are part of the scope of supply.

- LED indications
The following states are indicated by means of LEDs on the laterally mounted solid-state module:
 - Contactor ON (energized state): green LED ("ON")
 - Automatic/local control: green LED ("AUTO")
 - Bus status: green/red dual LED ("AS-i")
 - Remaining lifetime indicator (RLT)
- AS-Interface addressing socket "ADDR":
The contactor address can be assigned after installation.

3RT, 3TB, 3TF Contactors for Switching Motors

3RT10 contactors, 3-pole, 3 ... 250 kW

Control circuit:

- Contactor control through AS-Interface by way of terminals AS-i +/AS-i -. Each of these terminals is jumpered and connected twice to a 4-pole connector which is separate from the other control inputs.

Advantages:

- The AS-Interface cable is not interrupted if the plug is pulled out
- The contactor remains functional through the local control inputs and its own 6-pole connector
- Control signals through AS-i:
 - Contactor ON/OFF
- Status signals through AS-i:
 - Contactor ON/OFF
 - Automatic/Local control
 - Remaining lifetime indicator (RLT)
 - Signal through free input, e. g. overload relay tripped.

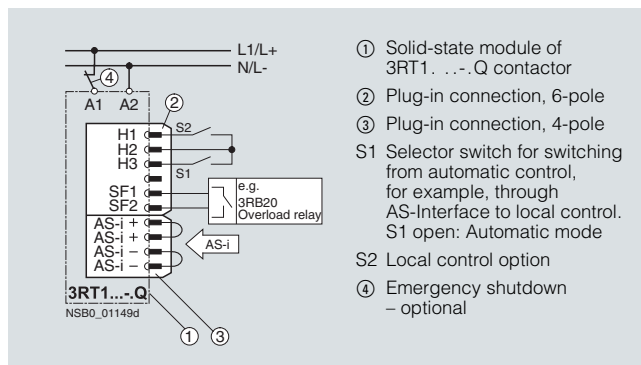

Possibility of switching from automatic control to local control by means of terminals H1/H2/H3, i.e. automatic control through AS-Interface can be deactivated e. g. during start-up or in the event of a fault and the contactor can be controlled manually.

I/O configuration (hex)	7
ID code (hex)	F
Power supply	V 26.5 ... 31.6 (acc. to AS-Interface specification)
AS-Interface power consumption	mA max. 20
Contact loading at SF1/2	mA 3 ... 6
Watchdog function (disconnects outputs in the event of AS-Interface fault)	Built-in

Indication

During operation, the LEDs on the contactor indicate the states shown on the right.

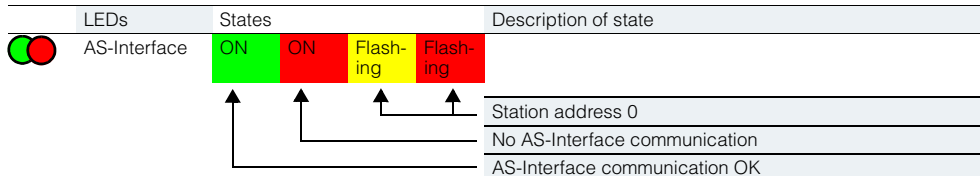

Contactor diagnostics using the user program

Inputs

Input signals	Device status
DI0 "Ready"	0 Device not ready/manual operation 1 Device ready/automatic mode
DI1 "Running"	0 Contactor off 1 Contactor on
DI2 "Remaining lifetime"	0 Remaining lifetime RLT > 20 % 1 Remaining lifetime RLT ≤ 20 %
DI3 "Free input"	0 No input signal at SF1/2 1 Input signal at SF1/2

Outputs

Output signals	Device status
DO0 "Running"	0 Contactor off 1 Contactor on
DO1	0 -- 1 --
DO2	0 -- 1 --
DO3	0 -- 1 --

3RT, 3TB, 3TF Contactors for Switching Motors

3RT10 contactors, 3-pole, 3 ... 250 kW

Selection and ordering data

AC operation

PU (UNIT, SET, M) = 1
 PS* = 1 unit
 PG = 101



3RT10 1.-1A...



3RT10 1.-2A...

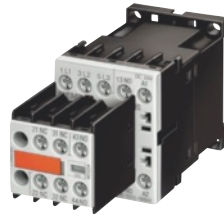

3RT10 1.-1AP04-3MA0

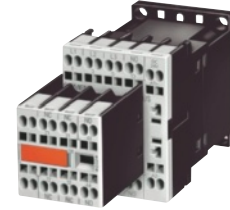

3RT10 1.-2AP04-3MA0

Rated data		Auxiliary contacts		Rated control supply voltage U_s at 50/60 Hz	DT	Screw terminals		Weight per PU approx.	DT	Cage Clamp terminals		Weight per PU approx.
AC-2 and AC-3, T_U : up to 60 °C	AC-1, T_U : 40 °C	Ident. No.	Version			Order No.	Price per PU			Order No.	Price per PU	
Operational current I_e up to 400 V	Rating of induction motors at 50 Hz and 400 V	Operational current I_e up to 690 V	NO NC	V AC								
A	kW	A										kg

For screw and snap-on mounting onto 35 mm standard mounting rail

Size S00¹⁾

Terminal designations according to EN 50012

7	3	18	10 E	1	--	24	▶	3RT10 15-1AB01	0.200	▶	3RT10 15-2AB01	0.200
						110	▶	3RT10 15-1AF01	0.200	▶	3RT10 15-2AF01	0.200
						230	▶	3RT10 15-1AP01	0.200	▶	3RT10 15-2AP01	0.200
			01	--	1	24	▶	3RT10 15-1AB02	0.200	▶	3RT10 15-2AB02	0.200
						110	▶	3RT10 15-1AF02	0.200	▶	3RT10 15-2AF02	0.200
						230	▶	3RT10 15-1AP02	0.200	▶	3RT10 15-2AP02	0.200
9	4	22	10 E	1	--	24	▶	3RT10 16-1AB01	0.200	▶	3RT10 16-2AB01	0.200
						110	▶	3RT10 16-1AF01	0.200	▶	3RT10 16-2AF01	0.200
						230	▶	3RT10 16-1AP01	0.200	▶	3RT10 16-2AP01	0.200
			01	--	1	24	▶	3RT10 16-1AB02	0.200	▶	3RT10 16-2AB02	0.200
						110	▶	3RT10 16-1AF02	0.200	▶	3RT10 16-2AF02	0.200
						230	▶	3RT10 16-1AP02	0.200	▶	3RT10 16-2AP02	0.200
12	5.5	22	10 E	1	--	24	▶	3RT10 17-1AB01	0.200	▶	3RT10 17-2AB01	0.200
						110	▶	3RT10 17-1AF01	0.200	▶	3RT10 17-2AF01	0.200
						230	▶	3RT10 17-1AP01	0.200	▶	3RT10 17-2AP01	0.200
			01	--	1	24	▶	3RT10 17-1AB02	0.200	▶	3RT10 17-2AB02	0.200
						110	▶	3RT10 17-1AF02	0.200	▶	3RT10 17-2AF02	0.200
						230	▶	3RT10 17-1AP02	0.200	▶	3RT10 17-2AP02	0.200

Size S00¹⁾

With permanently mounted auxiliary switch block for safety applications according to SUVA

Terminal designations according to EN 50012

7	3	18	22 E	2	2	230	▶	3RT10 15-1AP04-3MA0	0.250	B	3RT10 15-2AP04-3MA0	0.250
9	4	22	22 E	2	2	230	▶	3RT10 16-1AP04-3MA0	0.250	B	3RT10 16-2AP04-3MA0	0.250
12	5.5	22	22 E	2	2	230	▶	3RT10 17-1AP04-3MA0	0.250	B	3RT10 17-2AP04-3MA0	0.250

For other voltages see page 3/26, for contactors with permanently mounted auxiliary switch block please inquire.

For accessories, see page 3/100.

For multi-unit packing and reusable packaging, see "Appendix --> Ordering notes".

¹⁾ For size S00: coil operating range
 at 50 Hz: 0.8 ... 1,1 x U_s ,
 at 60 Hz: 0.85 ... 1,1 x U_s .

3RT, 3TB, 3TF Contactors for Switching Motors

3RT10 contactors, 3-pole, 3 ... 250 kW

AC operation

PU (UNIT, SET, M) = 1
 PS* = 1 unit
 PG = 101



3RT10 2.-1A.00



3RT10 2.-3A.00



3RT10 2.-1A.04



3RT10 2.-1AL24-3MA0

Rated data		Auxiliary contacts		Rated control supply voltage U_s at 50 Hz	DT	Screw terminals		Weight per PU approx.	DT	Cage Clamp terminals		Weight per PU approx.
AC-2 and AC-3, T_U : up to 60 °C	AC-1, T_U : 40 °C	Operational current I_e up to	Ident. No.			Version	Order No.			Price per PU	For coil terminals	
400 V	400 V	690 V										
A	kW	A		NO NC V AC			kg				kg	

For screw and snap-on mounting onto 35 mm standard mounting rail

Size S0

Size	Power (kW)	Voltage (V)	Ident. No.	Version	Rated current (A)	Order No.	Weight (kg)	Order No.	Weight (kg)
9	4	40 ¹⁾	--	--	24	▶ 3RT10 23-1AB00	0.350 B	3RT10 23-3AB00	0.350
					110	▶ 3RT10 23-1AF00	0.350 B	3RT10 23-3AF00	0.350
					230	▶ 3RT10 23-1AP00	0.350 ▶	3RT10 23-3AP00	0.350
12	5.5	40 ¹⁾	--	--	24	▶ 3RT10 24-1AB00	0.350 B	3RT10 24-3AB00	0.350
					110	▶ 3RT10 24-1AF00	0.350 B	3RT10 24-3AF00	0.350
					230	▶ 3RT10 24-1AP00	0.350 ▶	3RT10 24-3AP00	0.350
17	7.5	40 ¹⁾	--	--	24	▶ 3RT10 25-1AB00	0.350 B	3RT10 25-3AB00	0.350
					110	▶ 3RT10 25-1AF00	0.350 B	3RT10 25-3AF00	0.350
					230	▶ 3RT10 25-1AP00	0.350 ▶	3RT10 25-3AP00	0.350
25	11	40 ¹⁾	--	--	24	▶ 3RT10 26-1AB00	0.350 B	3RT10 26-3AB00	0.350
					110	▶ 3RT10 26-1AF00	0.350 B	3RT10 26-3AF00	0.350
					230	▶ 3RT10 26-1AP00	0.350 ▶	3RT10 26-3AP00	0.350

Size S0

With mounted auxiliary switch block (removable)²⁾

Terminal designations according to EN 50012

Size	Power (kW)	Voltage (V)	Ident. No.	Version	Rated current (A)	Order No.	Weight (kg)	Order No.	Weight (kg)
9	4	40 ¹⁾	22 E	2 2	24	▶ 3RT10 23-1AB04	0.400	--	--
					110	▶ 3RT10 23-1AF04	0.400	--	--
					230	▶ 3RT10 23-1AP04	0.400	--	--
12	5.5	40 ¹⁾	22 E	2 2	24	▶ 3RT10 24-1AB04	0.400	--	--
					110	▶ 3RT10 24-1AF04	0.400	--	--
					230	▶ 3RT10 24-1AP04	0.400	--	--
17	7.5	40 ¹⁾	22 E	2 2	24	▶ 3RT10 25-1AB04	0.400	--	--
					110	▶ 3RT10 25-1AF04	0.400	--	--
					230	▶ 3RT10 25-1AP04	0.400	--	--
25	11	40 ¹⁾	22 E	2 2	24	▶ 3RT10 26-1AB04	0.400	--	--
					110	▶ 3RT10 26-1AF04	0.400	--	--
					230	▶ 3RT10 26-1AP04	0.400	--	--

Size S0

With permanently mounted auxiliary switch block for safety applications according to SUVA

at 50/60 Hz
V AC

Terminal designations according to EN 50012

Size	Power (kW)	Voltage (V)	Ident. No.	Version	Rated current (A)	Order No.	Weight (kg)	Order No.	Weight (kg)
12	5.5	40 ¹⁾	22 E	2 2	230	B 3RT10 24-1AL24-3MA0	0.420	--	--
17	7.5	40 ¹⁾	22 E	2 2	230	A 3RT10 25-1AL24-3MA0	0.420	--	--
25	11	40 ¹⁾	22 E	2 2	230	A 3RT10 26-1AL24-3MA0	0.420	--	--

For other voltages see page 3/26, for contactors with permanently mounted auxiliary switch block please inquire.

For accessories, see page 3/101.

For spare parts, see page 3/114.

For multi-unit packing and reusable packaging, see "Appendix --> Ordering notes".

¹⁾ Minimum conductor cross-section 10 mm².

²⁾ Order No. for the auxiliary switch block (removable): 3RH19 21-1HA22 (2NO + 2NC according to EN 50012; 22E).

3RT, 3TB, 3TF Contactors for Switching Motors

3RT10 contactors, 3-pole, 3 ... 250 kW

AC operation

PU (UNIT, SET, M) = 1
 PS* = 1 unit
 PG = 101



3RT10 3.-1A.00



3RT10 3.-3A.00



3RT10 3.-1A.04

Rated data		Auxiliary contacts		Rated control supply voltage U_s at 50 Hz	DT	Screw terminals		Weight per PU approx.	DT	Cage Clamp terminals		Weight per PU approx.
AC-2 and AC-3, T_U : up to 60 °C	AC-1, T_U : 40 °C	Ident. No.	Version			Order No.	Price per PU			Order No.	Price per PU	
Operational current I_e up to 400 V	Rating of induction motors at 50 Hz and 400 V	Operational current I_e up to 690 V										
A	kW	A	NO NC V AC					kg				kg

For screw and snap-on mounting onto 35 mm standard mounting rail

Size S2

32	15	50	--	--	--	24 110 230	▶ 3RT10 34-1AB00 ▶ 3RT10 34-1AF00 ▶ 3RT10 34-1AP00	0.850 B 0.850 B 0.850 ▶		3RT10 34-3AB00 3RT10 34-3AF00 3RT10 34-3AP00	0.850 0.850 0.850
40	18.5	60	--	--	--	24 110 230	▶ 3RT10 35-1AB00 ▶ 3RT10 35-1AF00 ▶ 3RT10 35-1AP00	0.850 B 0.850 B 0.850 ▶		3RT10 35-3AB00 3RT10 35-3AF00 3RT10 35-3AP00	0.850 0.850 0.850
50	22	60	--	--	--	24 110 230	▶ 3RT10 36-1AB00 ▶ 3RT10 36-1AF00 ▶ 3RT10 36-1AP00	0.850 B 0.850 B 0.850 ▶		3RT10 36-3AB00 3RT10 36-3AF00 3RT10 36-3AP00	0.850 0.850 0.850

Size S2

With mounted auxiliary switch block (removable)¹⁾

Terminal designations according to EN 50012

32	15	50	22 E	2	2	24 110 230	▶ 3RT10 34-1AB04 ▶ 3RT10 34-1AF04 ▶ 3RT10 34-1AP04	0.950 0.950 0.950	-- -- --		
40	18.5	60	22 E	2	2	24 110 230	▶ 3RT10 35-1AB04 ▶ 3RT10 35-1AF04 ▶ 3RT10 35-1AP04	0.950 0.950 0.950	-- -- --		
50	22	60	22 E	2	2	24 110 230	▶ 3RT10 36-1AB04 ▶ 3RT10 36-1AF04 ▶ 3RT10 36-1AP04	0.950 0.950 0.950	-- -- --		

Size S2

With permanently mounted auxiliary switch block for safety applications according to SUVA

Terminal designations according to EN 50012

32	15	50	22 E	2	2	230	B	3RT10 34-1AP04-3MA0	0.908	--	
40	18.5	50	22 E	2	2	230	▶	3RT10 35-1AP04-3MA0	0.950	--	
50	22	50	22 E	2	2	230	B	3RT10 36-1AP04-3MA0	0.935	--	

For other voltages see page 3/26, for contactors with mounted auxiliary switch block please inquire.

For accessories, see page 3/101.

For spare parts, see page 3/114.

For multi-unit packing and reusable packaging, see "Appendix --> Ordering notes".

¹⁾ Order No. for the auxiliary switch block (removable): 3RH19 21-1HA22 (2NO + 2NC according to EN 50012; 22E).

3RT, 3TB, 3TF Contactors for Switching Motors

3RT10 contactors, 3-pole, 3 ... 250 kW

AC operation

PU (UNIT, SET, M) = 1
 PS* = 1 unit
 PG = 101



3RT10 4.-1A.00



3RT10 4.-3A.00

Rated data		Auxiliary contacts		Rated control supply voltage U_s at 50 Hz	DT	Screw terminals	Weight per PU approx.	DT	Cage Clamp terminals	Weight per PU approx.
AC-2 and AC-3, T_U : up to 60 °C	AC-1, T_U : 40 °C	Ident. No.	Version			⊕			⊕	
Operational current I_e up to 400 V	Rating of induction motors at 50 Hz and 690 V					Order No.	Price per PU		Order No.	Price per PU
A	kW	A	NO NC V AC				kg			kg

For screw and snap-on mounting onto 35 mm and 75 mm standard mounting rail

Size S3

Rated current	Rated power	Rated current	Ident. No.	Version	DT	Order No.	Weight per PU approx.	DT	Order No.	Weight per PU approx.
65	30	100	--	--	24	▶ 3RT10 44-1AB00	1.800	B	3RT10 44-3AB00	1.800
					110	▶ 3RT10 44-1AF00	1.800	B	3RT10 44-3AF00	1.800
					230	▶ 3RT10 44-1AP00	1.800	▶	3RT10 44-3AP00	1.800
80	37	120	--	--	24	▶ 3RT10 45-1AB00	1.800	B	3RT10 45-3AB00	1.800
					110	▶ 3RT10 45-1AF00	1.800	B	3RT10 45-3AF00	1.800
					230	▶ 3RT10 45-1AP00	1.800	▶	3RT10 45-3AP00	1.800
95	45	120	--	--	24	▶ 3RT10 46-1AB00	1.800	B	3RT10 46-3AB00	1.800
					110	▶ 3RT10 46-1AF00	1.800	B	3RT10 46-3AF00	1.800
					230	▶ 3RT10 46-1AP00	1.800	▶	3RT10 46-3AP00	1.800

Size S3

With mounted auxiliary switch block (removable)¹⁾

Terminal designations according to EN 50012

Rated current	Rated power	Rated current	Ident. No.	Version	DT	Order No.	Weight per PU approx.	DT	Order No.	Weight per PU approx.
65	30	100	22 E	2 2	24	▶ 3RT10 44-1AB04	1.950	--		
					110	▶ 3RT10 44-1AF04	1.950	--		
					230	▶ 3RT10 44-1AP04	1.950	--		
80	37	120	22 E	2 2	24	B 3RT10 45-1AB04	1.950	--		
					110	▶ 3RT10 45-1AF04	1.950	--		
					230	▶ 3RT10 45-1AP04	1.950	--		
95	45	120	22 E	2 2	24	B 3RT10 46-1AB04	1.950	--		
					110	▶ 3RT10 46-1AF04	1.950	--		
					230	▶ 3RT10 46-1AP04	1.950	--		

Size S3

With permanently mounted auxiliary switch block

for safety applications according to SUVA

Terminal designations according to EN 50012

Rated current	Rated power	Rated current	Ident. No.	Version	DT	Order No.	Weight per PU approx.	DT	Order No.	Weight per PU approx.
65	30	50	22 E	2 2	230	▶ 3RT10 44-1AP04-3MA0	1.950	--		
80	37	50	22 E	2 2	230	B 3RT10 45-1AP04-3MA0	1.933	--		
95	45	50	22 E	2 2	230	▶ 3RT10 46-1AP04-3MA0	1.950	--		

For other voltages see page 3/26, for contactors with mounted auxiliary switch block please inquire.

For accessories, see page 3/101.

For spare parts, see page 3/115.

¹⁾ Order No. for the auxiliary switch block (removable): 3RH19 21-1HA22 (2NO + 2NC according to EN 50012; 22E).

3RT, 3TB, 3TF Contactors for Switching Motors

3RT10 contactors, 3-pole, 3 ... 250 kW

DC operation - DC solenoid system

PU (UNIT, SET, M) = 1
 PS* = 1 unit
 PG = 101



3RT10 1.-1B...



3RT10 1.-2B...

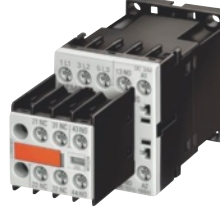

3RT10 1.-1BB44-3MA0

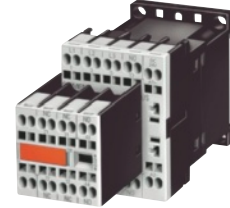

3RT10 1.-2BB44-3MA0

Rated data		Auxiliary contacts		Rated control supply voltage U_s	DT	Screw terminals	Weight per PU approx.	DT	Cage Clamp terminals	Weight per PU approx.
AC-2 and AC-3, T_U : up to 60 °C	AC-1, T_U : 40 °C	Ident. No.	Version			Order No.	Price per PU		Order No.	Price per PU
Operational current I_e up to 400 V	Rating of induction motors at 50 Hz and 690 V						kg			kg
A	kW	A	NO NC V DC							

For screw and snap-on mounting onto 35 mm standard mounting rail

Size S00

Terminal designations according to EN 50012

7	3	18	10 E	1	--	24	▶	3RT10 15-1BB41	0.260	▶	3RT10 15-2BB41	0.260
						220	A	3RT10 15-1BM41	0.260	B	3RT10 15-2BM41	0.260
			01	--	1	24	▶	3RT10 15-1BB42	0.260	▶	3RT10 15-2BB42	0.260
						220	B	3RT10 15-1BM42	0.260	B	3RT10 15-2BM42	0.260
9	4	22	10 E	1	--	24	▶	3RT10 16-1BB41	0.260	▶	3RT10 16-2BB41	0.260
						220	B	3RT10 16-1BM41	0.260	B	3RT10 16-2BM41	0.260
			01	--	1	24	▶	3RT10 16-1BB42	0.260	▶	3RT10 16-2BB42	0.260
						220	B	3RT10 16-1BM42	0.260	B	3RT10 16-2BM42	0.260
12	5.5	22	10 E	1	--	24	▶	3RT10 17-1BB41	0.260	▶	3RT10 17-2BB41	0.260
						220	B	3RT10 17-1BM41	0.260	B	3RT10 17-2BM41	0.260
			01	--	1	24	▶	3RT10 17-1BB42	0.260	▶	3RT10 17-2BB42	0.260
						220	B	3RT10 17-1BM42	0.260	B	3RT10 17-2BM42	0.260

Size S00

With permanently mounted auxiliary switch block for safety applications according to SUVA

Terminal designations according to EN 50012

7	3	18	22 E	2	2	24	▶	3RT10 15-1BB44-3MA0	0.300	B	3RT10 15-2BB44-3MA0	0.300
9	4	22	22 E	2	2	24	▶	3RT10 16-1BB44-3MA0	0.300	A	3RT10 16-2BB44-3MA0	0.300
12	5.5	22	22 E	2	2	24	▶	3RT10 17-1BB44-3MA0	0.300	B	3RT10 17-2BB44-3MA0	0.300

For other voltages see page 3/26, for contactors with permanently mounted auxiliary switch block please inquire.

For accessories, see page 3/100.

For multi-unit packing and reusable packaging, see "Appendix --> Ordering notes".

3RT, 3TB, 3TF Contactors for Switching Motors

3RT10 contactors, 3-pole, 3 ... 250 kW

DC operation - DC solenoid system

PU (UNIT, SET, M) = 1
 PS* = 1 unit
 PG = 101



3RT10 2.-1B.40



3RT10 2.-3B.40



3RT10 2.-3B.44



3RT10 2.-1BB44-3MA0

Rated data		Auxiliary contacts		Rated control supply voltage U_s	DT	Screw terminals		Weight per PU approx.	DT	Cage Clamp terminals		Weight per PU approx.
AC-2 and AC-3, T_U : up to 60 °C	AC-1, T_U : 40 °C	Operational current I_e up to 400 V	Rating of induction motors at 50 Hz and 400 V			Ident. No.	Version			Order No.	Price per PU	
A	kW	A						kg			kg	

For screw and snap-on mounting onto 35 mm standard mounting rail

Size S0

9	4	40 ¹⁾	--	--	--	24	▶	3RT10 23-1BB40	0.580	▶	3RT10 23-3BB40	0.580
						220		3RT10 23-1BM40	0.580	B	3RT10 23-3BM40	0.580
12	5.5	40 ¹⁾	--	--	--	24	▶	3RT10 24-1BB40	0.580	▶	3RT10 24-3BB40	0.580
						220		3RT10 24-1BM40	0.580	B	3RT10 24-3BM40	0.580
17	7.5	40 ¹⁾	--	--	--	24	▶	3RT10 25-1BB40	0.580	▶	3RT10 25-3BB40	0.580
						220		3RT10 25-1BM40	0.580	B	3RT10 25-3BM40	0.580
25	11	40 ¹⁾	--	--	--	24	▶	3RT10 26-1BB40	0.580	▶	3RT10 26-3BB40	0.580
						220		3RT10 26-1BM40	0.580	B	3RT10 26-3BM40	0.580

Size S0

With mounted auxiliary switch block (removable)²⁾

Terminal designations according to DIN 50012

9	4	40 ¹⁾	22 E	2	2	24	▶	3RT10 23-1BB44	0.650	--		
						220		3RT10 23-1BM44	0.650	--		
12	5.5	40 ¹⁾	22 E	2	2	24	▶	3RT10 24-1BB44	0.650	--		
						220		3RT10 24-1BM44	0.650	--		
17	7.5	40 ¹⁾	22 E	2	2	24	▶	3RT10 25-1BB44	0.650	--		
						220		3RT10 25-1BM44	0.650	--		
25	11	40 ¹⁾	22 E	2	2	24	▶	3RT10 26-1BB44	0.650	--		
						220		3RT10 26-1BM44	0.650	--		

Size S0

With permanently mounted auxiliary switch block for safety applications according to SUVA

Terminal designations according to DIN 50012

12	5.5	40 ¹⁾	22 E	2	2	24	A	3RT10 24-1BB44-3MA0	0.650	--		
17	7.5	40 ¹⁾	22 E	2	2	24	A	3RT10 25-1BB44-3MA0	0.650	--		
25	11	40 ¹⁾	22 E	2	2	24	A	3RT10 26-1BB44-3MA0	0.650	--		

For other voltages see page 3/26, for contactors with mounted auxiliary switch block please inquire.

For accessories, see page 3/101.

For multi-unit packing and reusable packaging, see "Appendix --> Ordering notes".

¹⁾ Minimum conductor cross-section 10 mm².

²⁾ Order No. for the auxiliary switch block (removable): 3RH19 21-1HA22 (2NO + 2NC according to EN 50012; 22E).

3RT, 3TB, 3TF Contactors for Switching Motors

3RT10 contactors, 3-pole, 3 ... 250 kW

DC operation - DC solenoid system

PU (UNIT, SET, M) = 1
 PS* = 1 unit
 PG = 101



3RT10 3.-1B.40



3RT10 4.-1B.40



3RT10 3.-3B.40



3RT10 4.-3B.40



3RT10 4.-1B.44

Rated data		Auxiliary contacts		Rated control supply voltage U_s	DT	Screw terminals		Weight per PU approx.	DT	Cage Clamp terminals		Weight per PU approx.
AC-2 and AC-3, T_{ij} : up to 60 °C	AC-1, T_{ij} : 40 °C	Operational current I_e up to	Rating of induction motors at 50 Hz and			Ident. No.	Version			Order No.	Price per PU	
400 V	400 V	690 V										
A	kW	A						kg				kg

For screw and snap-on mounting onto 35 mm standard mounting rail

Size S2

32	15	50	--	--	--	24	▶	3RT10 34-1BB40	1.450	▶	3RT10 34-3BB40	1.450
						220	A	3RT10 34-1BM40	1.450	B	3RT10 34-3BM40	1.450
40	18.5	60	--	--	--	24	▶	3RT10 35-1BB40	1.450	▶	3RT10 35-3BB40	1.450
						220	B	3RT10 35-1BM40	1.450	B	3RT10 35-3BM40	1.450
50	22	60	--	--	--	24	▶	3RT10 36-1BB40	1.450	▶	3RT10 36-3BB40	1.450
						220	B	3RT10 36-1BM40	1.450	B	3RT10 36-3BM40	1.450

Size S2

With mounted auxiliary switch block (removable)¹⁾

Terminal designations according to EN 50012

32	15	50	22 E	2	2	24	▶	3RT10 34-1BB44	1.550	--	--	--
						220	A	3RT10 34-1BM44	1.550	--	--	--
40	18.5	60	22 E	2	2	24	▶	3RT10 35-1BB44	1.550	--	--	--
						220	B	3RT10 35-1BM44	1.550	--	--	--
50	22	60	22 E	2	2	24	▶	3RT10 36-1BB44	1.550	--	--	--
						220	B	3RT10 36-1BM44	1.550	--	--	--

Size S2

With permanently mounted auxiliary switch block for safety applications according to SUVA

Terminal designations according to EN 50012

32	15	50	22 E	2	2	24	▶	3RT10 34-1BB44-3MA0	1.550	--	--	--
40	18.5	50	22 E	2	2	24	▶	3RT10 35-1BB44-3MA0	1.550	--	--	--
50	22	50	22 E	2	2	24	▶	3RT10 36-1BB44-3MA0	1.550	--	--	--

For screw and snap-on mounting onto 35 mm and 75 mm standard mounting rail

Size S3

65	30	100	--	--	--	24	▶	3RT10 44-1BB40	2.800	▶	3RT10 44-3BB40	2.800
						220	B	3RT10 44-1BM40	2.800	B	3RT10 44-3BM40	2.800
80	37	120	--	--	--	24	▶	3RT10 45-1BB40	2.800	▶	3RT10 45-3BB40	2.800
						220	B	3RT10 45-1BM40	2.800	B	3RT10 45-3BM40	2.800
95	45	120	--	--	--	24	▶	3RT10 46-1BB40	2.800	▶	3RT10 46-3BB40	2.800
						220	B	3RT10 46-1BM40	2.800	B	3RT10 46-3BM40	2.800

* You can order this quantity or a multiple thereof.

3RT, 3TB, 3TF Contactors for Switching Motors

3RT10 contactors, 3-pole, 3 ... 250 kW

PU (UNIT, SET, M) = 1
 PS* = 1 unit
 PG = 101



3RT10 3.-1B.40



3RT10 4.-1B.40



3RT10 3.-3B.40



3RT10 4.-3B.40



3RT10 4.-1B.44

Rated data		Auxiliary contacts		Rated control supply voltage U_c	DT	Screw terminals		Weight per PU approx.	DT	Cage Clamp terminals		Weight per PU approx.
AC-2 and AC-3, T_U : up to 60 °C	AC-1, T_U : 40 °C	Operational current I_e up to	Rating of induction motors at 50 Hz and			Ident. No.	Version			Order No.	Price per PU	
400 V	400 V	A	690 V									
A	kW	A										kg

For screw and snap-on mounting onto 35 mm and 75 mm standard mounting rail (continued)

Size S3

With mounted auxiliary switch block (removable)¹⁾

Terminal designations according to EN 50012

65	30	100	22 E	2	2	24						
						220	▶	3RT10 44-1BB44	2.900	--		
							B	3RT10 44-1BM44	2.900	--		
80	37	120	22 E	2	2	24	▶	3RT10 45-1BB44	2.900	--		
						220	B	3RT10 45-1BM44	2.900	--		
95	45	120	22 E	2	2	24	▶	3RT10 46-1BB44	2.900	--		
						220	B	3RT10 46-1BM44	2.900	--		

Size S3

With permanently mounted auxiliary switch block for safety applications according to SUVA

Terminal designations according to EN 50012

65	30	50	22 E	2	2	24						
							▶	3RT10 44-1BB44-3MA0	2.900	--		
80	37	50	22 E	2	2	24	▶	3RT10 45-1BB44-3MA0	2.900	--		
95	45	50	22 E	2	2	24	▶	3RT10 46-1BB44-3MA0	2.900	--		

For other voltages see page 3/26, for contactors with mounted auxiliary switch block please inquire.

For accessories, see page 3/101.

For spare parts, see page 3/115.

For multi-unit packing and reusable packaging, see "Appendix --> Ordering notes".

¹⁾ Order No. for the auxiliary switch block (removable): 3RH19 21-1HA22 (2NO + 2NC according to EN 50012; 22E).

3RT, 3TB, 3TF Contactors for Switching Motors

3RT10 contactors, 3-pole, 3 ... 250 kW

AC/DC operation (40 Hz to 60 Hz, DC)

Auxiliary and control conductors: screw terminals

Withdrawable coils

Integrated coil circuit (Varistor)

Main conductors: busbar connections, for 3RT10 54 (55 kW) box terminals¹⁾



3RT1. 5.



3RT1. 6.



3RT1. 7.

Size	Rated data					Auxiliary contacts, lateral		Rated control supply voltage U_s	DT	Order No.	Price per PU	PU (UNIT, SET, M)	PS*	PG	Weight per PU approx.
	AC-2 and AC-3, T_U : Up to 60 °C					AC-1, T_U : 40 °C									
	Operational current I_e up to 500 V					Operational current I_e up to 690 V									
	Ratings of induction motors at 50 Hz and					Version									
	230 V	400 V	500 V	690 V	690 V										
A	kW	kW	kW	kW	A	NO	NC	V AC/DC							

Conventional operating mechanisms

										Screw terminals						
S6	115	37	55	75	110	160	2	2	110 ... 127 220 ... 240	▶	3RT10 54-1AF36 3RT10 54-1AP36		1	1 unit	101	3.600
	150	45	75	90	132	185	2	2	110 ... 127 220 ... 240	▶	3RT10 55-6AF36 3RT10 55-6AP36		1	1 unit	101	3.500
	185	55	90	110	160	215	2	2	110 ... 127 220 ... 240	▶	3RT10 56-6AF36 3RT10 56-6AP36		1	1 unit	101	3.500
S10	225	55	110	160	200	275	2	2	110 ... 127 220 ... 240	▶	3RT10 64-6AF36 3RT10 64-6AP36		1	1 unit	101	6.500
	265	75	132	160	250	330	2	2	110 ... 127 220 ... 240	▶	3RT10 65-6AF36 3RT10 65-6AP36		1	1 unit	101	6.500
	300	90	160	200	250	330	2	2	110 ... 127 220 ... 240	▶	3RT10 66-6AF36 3RT10 66-6AP36		1	1 unit	101	6.500
S12	400	132	200	250	400	430	2	2	110 ... 127 220 ... 240	▶	3RT10 75-6AF36 3RT10 75-6AP36		1	1 unit	101	10.500
	500	160	250	355	400	610	2	2	110 ... 127 220 ... 240	▶	3RT10 76-6AF36 3RT10 76-6AP36		1	1 unit	101	10.500

Conventional operating mechanisms

										Cage Clamp terminals						
S6	115	37	55	75	110	160	2	2	110 ... 127 220 ... 240	B	3RT10 54-3AF36 3RT10 54-3AP36		1	1 unit	101	3.600
	150	45	75	90	132	185	2	2	110 ... 127 220 ... 240	B	3RT10 55-2AF36 3RT10 55-2AP36		1	1 unit	101	3.600
	185	55	90	110	160	215	2	2	110 ... 127 220 ... 240	B	3RT10 56-2AF36 3RT10 56-2AP36		1	1 unit	101	3.600
S10	225	55	110	160	200	275	2	2	110 ... 127 220 ... 240	B	3RT10 64-2AF36 3RT10 64-2AP36		1	1 unit	101	6.600
	265	75	132	160	250	330	2	2	110 ... 127 220 ... 240	B	3RT10 65-2AF36 3RT10 65-2AP36		1	1 unit	101	6.600
	300	90	160	200	250	330	2	2	110 ... 127 220 ... 240	B	3RT10 66-2AF36 3RT10 66-2AP36		1	1 unit	101	6.600
S12	400	132	200	250	400	430	2	2	110 ... 127 220 ... 240	B	3RT10 75-2AF36 3RT10 75-2AP36		1	1 unit	101	10.500
	500	160	250	355	400	610	2	2	110 ... 127 220 ... 240	B	3RT10 76-2AF36 3RT10 76-2AP36		1	1 unit	101	10.500

For other voltages, see page 3/26.

For accessories, see page 3/101.

For spare parts, see page 3/116.

¹⁾ Alternatively the 3RT10 54-1 contactor (55 kW) can be supplied with busbar connections instead of box terminals. Without additional price. In the 8th position of the Order No. the "1" must be replaced with "6" for screw terminals, e. g. 3RT10 54-6A.36; for Cage Clamp terminals the "3" must be replaced by "2", e. g. 3RT10 54-2A.36.

3RT, 3TB, 3TF Contactors for Switching Motors

3RT10 contactors, 3-pole, 3 ... 250 kW

AC/DC operation (40 Hz to 60 Hz, DC)

Auxiliary and control conductors: screw terminals

Withdrawable coils

Integrated coil circuit (Varistor)

Main conductors: busbar connections, for 3RT10 54 (55 kW) box terminals¹⁾



3RT1. 5.



3RT1. 6.



3RT1. 7.

Size	Rated data					AC-1, T _i : 40 °C	Auxiliary contacts, lateral		Rated control supply voltage U _s	DT	Order No.	Price per PU	PU (UNIT, SET, M)	PS*	PG	Weight per PU approx.
	AC-2 and AC-3, T _i : Up to 60 °C		Ratings of induction motors at 50 Hz and			Operational current I _e up to 690 V	Version		V AC/DC							
	Operational current I _e up to 500 V	230 V	400 V	500 V	690 V		I	L ₁								
	A	kW	kW	kW	kW	A	NO	NC								kg
Solid-state operating mechanisms · for 24 V DC PLC output																
											Screw terminals					
S6	115	37	55	75	110	160	2	2	96 ... 127 200 ... 277	A	3RT10 54-1NF36 3RT10 54-1NP36		1	1 unit	101	3.500
	150	45	75	90	132	185	2	2	96 ... 127 200 ... 277	A	3RT10 55-6NF36 3RT10 55-6NP36		1	1 unit	101	3.500
	185	55	90	110	160	215	2	2	96 ... 127 200 ... 277	A	3RT10 56-6NF36 3RT10 56-6NP36		1	1 unit	101	3.500
S10	225	55	110	160	200	275	2	2	96 ... 127 200 ... 277	A	3RT10 64-6NF36 3RT10 64-6NP36		1	1 unit	101	6.700
	265	75	132	160	250	330	2	2	96 ... 127 200 ... 277	A	3RT10 65-6NF36 3RT10 65-6NP36		1	1 unit	101	6.700
	300	90	160	200	250	330	2	2	96 ... 127 200 ... 277	B	3RT10 66-6NF36 3RT10 66-6NP36		1	1 unit	101	6.700
S12	400	132	200	250	400	430	2	2	96 ... 127 200 ... 277	A	3RT10 75-6NF36 3RT10 75-6NP36		1	1 unit	101	10.500
	500	160	250	355	400	610	2	2	96 ... 127 200 ... 277	A	3RT10 76-6NF36 3RT10 76-6NP36		1	1 unit	101	10.500
Solid-state operating mechanisms · for 24 V DC PLC output																
											Cage Clamp terminals					
S6	115	37	55	75	110	160	2	2	96 ... 127 200 ... 277	B	3RT10 54-3NF36 3RT10 54-3NP36		1	1 unit	101	3.500
	150	45	75	90	132	185	2	2	96 ... 127 200 ... 277	B	3RT10 55-2NF36 3RT10 55-2NP36		1	1 unit	101	3.500
	185	55	90	110	160	215	2	2	96 ... 127 200 ... 277	B	3RT10 56-2NF36 3RT10 56-2NP36		1	1 unit	101	3.500
S10	225	55	110	160	200	275	2	2	96 ... 127 200 ... 277	B	3RT10 64-2NF36 3RT10 64-2NP36		1	1 unit	101	6.700
	265	75	132	160	250	330	2	2	96 ... 127 200 ... 277	B	3RT10 65-2NF36 3RT10 65-2NP36		1	1 unit	101	6.700
	300	90	160	200	250	330	2	2	96 ... 127 200 ... 277	B	3RT10 66-2NF36 3RT10 66-2NP36		1	1 unit	101	6.700
S12	400	132	200	250	400	430	2	2	96 ... 127 200 ... 277	B	3RT10 75-2NF36 3RT10 75-2NP36		1	1 unit	101	10.500
	500	160	250	355	400	610	2	2	96 ... 127 200 ... 277	B	3RT10 76-2NF36 3RT10 76-2NP36		1	1 unit	101	10.500

For other voltages, see page 3/26.

For accessories, see page 3/101.

For spare parts, see page 3/114.

¹⁾ Alternatively the 3RT10 54-1 contactor (55 kW) can be supplied with busbar connections instead of box terminals. Without additional price. In the 8th position of the Order No. the "1" must be replaced with "6" for screw terminals, e. g. 3RT10 54-6A.36; for Cage Clamp terminals the "3" must be replaced by "2", e. g. 3RT10 54-2A.36.

3RT, 3TB, 3TF Contactors for Switching Motors

3RT10 contactors, 3-pole, 3 ... 250 kW

AC/DC operation (40 Hz to 60 Hz, DC)

Auxiliary and control conductors: screw terminals

Withdrawable coils

Integrated coil circuit (Varistor)

Main conductors: busbar connections, for 3RT10 54 (55 kW) box terminals¹⁾

Remaining lifetime indicator (RLT)



3RT10 56-6P..



3RT10 56-6Q..

Size	Rated data						Auxiliary contacts, lateral		Rated control supply voltage U_s	DT	Screw terminals	⊕	PU (UNIT, SET, M)	PS*	PG	Weight per PU approx.
	AC-2 and AC-3, T_U : Up to 60 °C		Ratings of induction motors at 50 Hz and				AC-1, T_U : 40 °C									
Operational current I_e up to	500 V	230 V	400 V	500 V	690 V	690 V	Operational current I_e up to			Order No.	Price per PU					
A	kW	kW	kW	kW	kW	A	NO	NC	V AC/DC						kg	
Solid-state operating mechanisms · for 24 V DC PLC output/ PLC relay output, with remaining lifetime indicator (RLT)																
S6	115	37	55	75	110	160	1	1	96 ... 127 200 ... 277	B	3RT10 54-1PF35 3RT10 54-1PP35		1	1 unit	101	4,000
	150	45	75	90	132	185	1	1	96 ... 127 200 ... 277	B	3RT10 55-6PF35 3RT10 55-6PP35		1	1 unit	101	4,000
	185	55	90	110	160	215	1	1	96 ... 127 200 ... 277	B	3RT10 56-6PF35 3RT10 56-6PP35		1	1 unit	101	4,000
S10	225	55	110	160	200	275	1	1	96 ... 127 200 ... 277	B	3RT10 64-6PF35 3RT10 64-6PP35		1	1 unit	101	7,000
	265	75	132	160	250	330	1	1	96 ... 127 200 ... 277	B	3RT10 65-6PF35 3RT10 65-6PP35		1	1 unit	101	7,000
	300	90	160	200	250	330	1	1	96 ... 127 200 ... 277	B	3RT10 66-6PF35 3RT10 66-6PP35		1	1 unit	101	7,000
S12	400	132	200	250	400	430	1	1	96 ... 127 200 ... 277	B	3RT10 75-6PF35 3RT10 75-6PP35		1	1 unit	101	10,500
	500	160	250	355	400	610	1	1	96 ... 127 200 ... 277	B	3RT10 76-6PF35 3RT10 76-6PP35		1	1 unit	101	10,500
Solid-state operating mechanisms · with AS-Interface and remaining lifetime indicator (RLT)																
S6	115	37	55	75	110	160	1	1	96 ... 127 200 ... 277	B	3RT10 54-1QF35 3RT10 54-1QP35		1	1 unit	101	4,000
	150	45	75	90	132	185	1	1	96 ... 127 200 ... 277	B	3RT10 55-6QF35 3RT10 55-6QP35		1	1 unit	101	4,000
	185	55	90	110	160	215	1	1	96 ... 127 200 ... 277	B	3RT10 56-6QF35 3RT10 56-6QP35		1	1 unit	101	4,000
S10	225	55	110	160	200	275	1	1	96 ... 127 200 ... 277	B	3RT10 64-6QF35 3RT10 64-6QP35		1	1 unit	101	7,000
	265	75	132	160	250	330	1	1	96 ... 127 00 ... 277	B	3RT10 65-6QF35 3RT10 65-6QP35		1	1 unit	101	7,000
	300	90	160	200	250	330	1	1	96 ... 127 200 ... 277	B	3RT10 66-6QF35 3RT10 66-6QP35		1	1 unit	101	7,000
S12	400	132	200	250	400	430	1	1	96 ... 127 200 ... 277	B	3RT10 75-6QF35 3RT10 75-6QP35		1	1 unit	101	10,500
	500	160	250	355	400	610	1	1	96 ... 127 200 ... 277	B	3RT10 76-6QF35 3RT10 76-6QP35		1	1 unit	101	10,500

For other voltages, see page 3/26.

For accessories, see page 3/101.

For spare parts, see page 3/116.

¹⁾ Alternatively the 3RT10 54-1 contactor (55 kW) can be supplied with busbar connections instead of box terminals. Without additional price. In the 8th position of the Order No. the "1" must be replaced with "6", e. g. 3RT10 54-6. .35.

3RT, 3TB, 3TF Contactors for Switching Motors

3RT10 contactors, 3-pole, 3 ... 250 kW

Rated control supply voltages (the 10th and 11th position of the order number must be changed)

Contactor type	3RT10 1	3RT10 2, 3RT10 3, 3RT10 4	3RT14 4	3RT13 1, 3RT15 1	3RT13 2 ... 3RT13 4, 3RT15 2 and 3RT15 3	3RT16
Rated control supply voltage U_s						

Sizes S00 ... S3

AC operation¹⁾

Solenoid coils for 50 Hz (exception: Size S00: 50 and 60 Hz²⁾)

24 V AC	B0	B0	B0	B0	B0	B0
42 V AC	D0	D0	D0	D0	--	--
48 V AC	H0	H0	H0	H0	--	--
110 V AC	F0	F0	F0	F0	F0	F0
230 V AC	P0	P0	P0	P0	P0	P0
400 V AC	V0	V0	V0	V0	V0	V0

Solenoid coils for 50 and 60 Hz²⁾

24 V AC	B0	C2	C2	B0	C2	C2
42 V AC	D0	D2	D2	D0	D2	--
48 V AC	H0	H2	H2	H0	H2	--
110 V AC	F0	G2	G2	F0	G2	G2
220 V AC	N2	N2	N2	N2	N2	N2
230 V AC	P0	L2	L2	P0	L2	L2

Solenoid coils (for USA and Canada³⁾)

50 Hz	60 Hz						
110 V AC	120 V AC	K6	K6	K6	K6	K6	K6
220 V AC	240 V AC	P6	P6	P6	P6	P6	P6

Solenoid coils (for Japan)

50/60 Hz ⁴⁾	60 Hz ⁵⁾						
100 V AC	110 V AC	G6	G6	G6	G6	G6	G6
200 V AC	220 V AC	N6	N6	N6	N6	N6	N6
400 V AC	440 V AC	R6	R6	R6	R6	R6	R6

DC operation¹⁾

12 V DC	A4	--	--	A4	--	--
24 V DC	B4	B4	B4	B4	B4	--
42 V DC	D4	D4	D4	D4	D4	--
48 V DC	W4	W4	W4	W4	--	--
60 V DC	E4	E4	E4	--	--	--
110 V DC	F4	F4	F4	F4	F4	--
125 V DC	G4	G4	G4	G4	G4	--
220 V DC	M4	M4	M4	M4	M4	--
230 V DC	P4	P4	P4	P4	--	--

Sizes S6 ... S12

AC/DC operation (AC 40 ... 60 Hz, DC)

Conventional operating mechanism

U_s min ... U_s max ⁶⁾	Contactor type	3RT1. 5.-.A 3RT1. 6.-.A 3RT1. 7.-.A	U_s min ... U_s max ⁶⁾	Contactor type	3RT1. 5.-.A 3RT1. 6.-.A 3RT1. 7.-.A
23 ... 26 V AC		B3	240 ... 277 V		U3
42 ... 48 V AC/DC		D3	380 ... 420 V		V3
110 ... 127 V		F3	440 ... 480 V		R3
200 ... 220 V		M3	500 ... 550 V		S3
220 ... 240 V		P3	575 ... 600 V		T3

Solid-state operating mechanism

U_s min ... U_s max ⁶⁾	Contactor type	3RT1. 5.-.N 3RT1. 6.-.N 3RT1. 7.-.N	3RT1. 5.-.P/Q 3RT1. 6.-.P/Q 3RT1. 7.-.P/Q
21 ... 27.3 V AC		B3	--
96 ... 127 V		F3	F3
200 ... 277 V		P3	P3

Examples

AC operating mechanism	3RT10 23-1AP00 3RT10 23-1AG20	Contactor with screw terminals; with solenoid coil for 50 Hz for rated control supply voltage 230 V AC. Contactor with screw terminals; with solenoid coil for 50/60 Hz for rated control supply voltage 110 V AC.
DC operating mechanism	3RT10 34-3BB40 3RT10 34-3BG40	Contactor with Cage Clamp terminals; for rated control supply voltage 24 V DC. Contactor with Cage Clamp terminals; for rated control supply voltage 125 V DC.

¹⁾ For deviating coil voltages and coil operating ranges of sizes S00 and S0, the 24 V DC SITOP Power power supply unit with wide range input (93 to 264 V AC; 30 to 264 V DC) can be used for coil excitation (see "Power Supplies" -> "SITOP power Power Supplies").

²⁾ Coil operating range
at 50 Hz: 0.8 to 1.1 x U_s
at 60 Hz: 0.85 to 1.1 x U_s .

³⁾ Coil operating range
Size S00: at 50 Hz: 0.85 to 1.1 x U_s
at 60 Hz: 0.8 to 1.1 x U_s
Sizes S0 to S3: at 50 Hz and 60 Hz: 0.8 to 1.1 x U_s .

⁴⁾ Coil operating range
Size S00: at 50/60 Hz: 0.85 to 1.1 x U_s
Sizes S0 to S3: at 50 Hz: 0.8 to 1.1 x U_s
at 60 Hz: 0.85 to 1.1 x U_s .

⁵⁾ Coil operating range
at 60 Hz: 0.8 to 1.1 x U_s .

⁶⁾ Operating range:
0.8 x U_s min to 1.1 x U_s max.

3RT, 3TB, 3TF Contactors for Switching Motors

3RT12 vacuum contactors, 3-pole, 110 ... 250 kW

Overview

- 3RT12 vacuum contactors for switching motors

Operating mechanism types

Two types of solenoid operation are available:

- Conventional operating mechanism, version 3RT12...-A
- Solid-state operating mechanism, version 3RT12...-N

UC operation

The contactors can be operated with AC (40 to 60 Hz) as well as with DC.

Withdrawable coils

For simple coil replacement, e. g. if the application is replaced, the solenoid coil can be pulled out upwards after the release mechanism has been actuated and can be replaced by any other coil of the same size.

Auxiliary contact complement

The contactors can be fitted with up to 8 lateral auxiliary contacts (identical auxiliary switch blocks from S0 to S12). Of these, no more than 4 are permitted to be NC contacts.

Selection and ordering data

AC/DC operation (40 Hz to 60 Hz, DC)

Auxiliary and control conductors: screw terminals

Withdrawable coils

Integrated coil circuit (Varistor)

Main conductors: busbar connections



3RT12 7.

3RT12 7.

Size	Rated data						Auxiliary contacts, lateral		Rated control supply voltage U_s	DT	Screw terminals	PU (UNIT, SET, M)	PS*	PG	Weight per PU approx.
	AC-2 and AC-3, T_U : up to 60 °C						AC-1, T_U : 40 °C				⊕				
	Operational current I_e up to 1000 V	Ratings of induction motors at 50 Hz and				Operational current I_e up to 1000 V					Order No.	Price per PU			
	A	kW	kW	kW	kW	A	NO	NC	V AC/DC						kg
Conventional operating mechanisms															
S10	225	55	110	160	200	330	2	2	110 ... 127 220 ... 240	A	3RT12 64-6AF36 3RT12 64-6AP36	1	1 unit	101	7.300
	265	75	132	160	250	330	2	2	110 ... 127 220 ... 240	A	3RT12 65-6AF36 3RT12 65-6AP36	1	1 unit	101	7.300
	300	90	160	200	250	330	2	2	110 ... 127 220 ... 240	A	3RT12 66-6AF36 3RT12 66-6AP36	1	1 unit	101	7.300
S12	400	132	200	250	400	610	2	2	110 ... 127 220 ... 240	A	3RT12 75-6AF36 3RT12 75-6AP36	1	1 unit	101	10.500
	500	160	250	355	500	610	2	2	110 ... 127 220 ... 240	A	3RT12 76-6AF36 3RT12 76-6AP36	1	1 unit	101	10.500
Solid-state operating mechanisms · for 24 V DC PLC output															
S10	225	55	110	160	200	330	2	2	96 ... 127 200 ... 277	B	3RT12 64-6NF36 3RT12 64-6NP36	1	1 unit	101	7.300
	265	75	132	160	250	330	2	2	96 ... 127 200 ... 277	B	3RT12 65-6NF36 3RT12 65-6NP36	1	1 unit	101	7.300
	300	90	160	200	250	330	2	2	96 ... 127 200 ... 277	B	3RT12 66-6NF36 3RT12 66-6NP36	1	1 unit	101	7.300
S12	400	132	200	250	400	610	2	2	96 ... 127 200 ... 277	B	3RT12 75-6NF36 3RT12 75-6NP36	1	1 unit	101	10.500
	500	160	250	355	500	610	2	2	96 ... 127 200 ... 277	B	3RT12 76-6NF36 3RT12 76-6NP36	1	1 unit	101	10.500

For other voltages see page 3/26.

For more 3TF68/69 vacuum contactors (335 kW and 450 kW), see page 3/28.

For accessories, see page 3/103.

3RT, 3TB, 3TF Contactors for Switching Motors

3TF6 vacuum contactors, 3-pole, 335 ... 450 kW

Selection and ordering data

Auxiliary and control conductors: screw terminals
Main conductors: busbar connections, size 14

IEC 60947-4-1, EN 60947-4-1 (VDE 0660 Part 102)

The 3TF68/69 contactors are climate-proof.

They are finger-safe according to EN 50274.

Terminal covers (see [Accessories and Spare Parts on page 3/117](#)) may have to be fitted onto the connecting bars, depending on the configuration with other devices.



3TF68

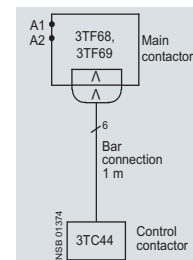

3TF6. 33-.Q.7

Rated data		AC-2 and AC-3 (up to 55 °C)					AC-1	Auxiliary contacts		Rated control supply voltage U_s	DT	Screw terminals	PU (UNIT, SET, M)	PS*	PG	Weight per PU approx.
Operational current I_e up to 690 V	Ratings of induction motors at 50 Hz and					Rated operational current I_e (at 40 °C)	Version					Order No.	Price per PU			
	230 V	400 V	500 V	690 V	1000 V		A	NO								
A	kW	kW	kW	kW	kW	A										kg
AC operation^{1) 2)} · 50/60 Hz																
630	200	335	434	600	--	700	4	4	110 ... 132 200 ... 240	A	3TF68 44-0CF7 3TF68 44-0CM7	1	1	unit	101	20.000
630	200	335	434	600	600	700	4	4	110 ... 132 200 ... 240	D	3TF68 44-8CF7 3TF68 44-8CM7	1	1	unit	101	20.000
820	260	450	600	800	--	910	4	4	110 ... 132 200 ... 240	A	3TF69 44-0CF7 3TF69 44-0CM7	1	1	unit	101	22.200
820	260	450	600	800	800	910	4	4	110 ... 132 200 ... 240	D	3TF69 44-8CF7 3TF69 44-8CM7	1	1	unit	101	22.200
DC operation · DC economy circuit²⁾																
630	200	335	434	600	--	700	3	3	24 DC	D	3TF68 33-1DB4 3TF68 33-8DB4	1	1	unit	101	19.500
820	260	450	600	800	--	910	3	3	24 DC	D	3TF69 33-1DB4 3TF69 33-8DB4	1	1	unit	101	22.500
AC operation · 50/60 Hz²⁾																
Version for AC controls which are subject to strong interference																
630	200	335	434	600	--	700	3	3	110 ... 120 220 ... 240 380 ... 420	C	3TF68 33-1QG7 3TF68 33-1QL7 3TF68 33-1QV7	1	1	unit	101	21.000
					600	700	3	3	220 ... 240	D	3TF68 33-8QL7	1	1	unit	101	21.000
820	260	450	600	800	--	910	3	3	110 ... 120 220 ... 240 380 ... 420	D	3TF69 33-1QG7 3TF69 33-1QL7 3TF69 33-1QV7	1	1	unit	101	23.000
					800	910	3	3	110 ... 120 220 ... 240	D	3TF69 33-8QG7 3TF69 33-8QL7	1	1	unit	101	23.000

3TC44 17-4A... reversing contactors included in the scope of supply.

¹⁾ Built-in surge suppression: varistor circuit.

²⁾ For EMC see [Technical Information LV 1 T](#).

3TF68/69 vacuum contactors are supplied with integrated overvoltage damping for the main current paths (for description see [Technical Information LV 1 T](#)). The surge suppression circuit is not required for operation in circuits with DC choppers, frequency converters or speed-variable

operating mechanisms, for example. It could be damaged by the voltage peaks and harmonics and cause phase-to-phase short-circuits. For this reason, the contactors can also be supplied without integrated overvoltage damping. Without additional price.

The order number must include "**Z**" and the order code "**A02**".

Rated control supply voltages (the 10th and 11th position of the order number must be changed)

Contactor type	3TF68 ... C/D, 3TF69 ... C/D
AC operation	
Solenoid coils for 50/60 Hz	
110 ... 132 V AC	F7
200 ... 240 V AC	M7
230 ... 277 V AC	P7
380 ... 460 V AC	Q7
500 ... 600 V AC	S7
DC operation	
24 V DC	B4
110 V DC	F4
125 V DC	G4
220 V DC	M4
230 V DC	P4

* You can order this quantity or a multiple thereof.

3RT, 3TB, 3TF Contactors for Switching Motors

3TB5 contactors with DC solenoid system,
3-pole, 55 ... 200 kW

Selection and ordering data

Auxiliary and control conductors: screw terminals
Main conductors: busbar connections



3TB50

Size	Rated data						Auxiliary contacts		Rated control supply voltage U_s	DT	Screw terminals 		PU (UNIT, SET, M)	PS*	PG	Weight per PU approx.
	AC-2 and AC-3 (up to 55 °C)			AC-1			Version				Order No.	Price per PU				
	Operational current I_e up to 690 V	Ratings of induction motors at 50 Hz and			Operational current I_e (at 40 °C)											
		230 V	400 V	500 V	690 V		NO	NC	V DC							kg
DC operation - DC solenoid system																
6	110	37	55	75	90	170	2	2	24	A	3TB50 17-0BB4		1	1 unit	101	6.500
8	170	55	90	110	132	230	2	2	24	B	3TB52 17-0BB4		1	1 unit	101	8.500
10	250	75	132	160	200	325	2	2	24	D	3TB54 17-0BB4		1	1 unit	101	16.500
12	400	115	200	255	355	425	2	2	24	D	3TB56 17-0BB4		1	1 unit	101	16.500

For accessories, see page 3/119.

For spare parts, see page 3/127.

Rated control supply voltages (the 10th and 11th position of the order number must be changed)

Rated control supply voltage U_s	Contactor type	3TB50/3TB52/3TB54	3TB56
DC operation			
24 V DC		B4	B4
110 V DC		F4	--
220 V DC		M4	M4

3RT, 3TB, 3TF Contactors for Switching Motors

3TF2 contactors, 3-pole, 2.2 ... 4 kW

Overview

AC and DC operation

IEC 60947 (VDE 0660).

The contactors are suitable for use in any climate.

The contactors with screw terminals are finger-safe according to EN 50274.

The contactors are available in versions with screw terminals, 6.3 mm plug-in terminals and solder pin connections for soldering in printed circuit boards.

Selection and ordering data

Size 00

AC-1: operational current $I_e = 16 A$ (at 55 °C)

Screw terminals

Rated data		Utilization categories AC-2 and AC-3				Auxiliary contacts		DT	Order No.	Price per PU	PU (UNIT, SET, M)	PS*	PG	Weight per PU approx.
Operational current I_e	at 400/380 V	Ratings of induction motors at 50 Hz and				Ident. No.	Version							
		230/220 V	400/380 V	500 V	690/660 V									
A	kW	kW	kW	kW			NO	NC						kg

Contactors with screw terminals - for screw and snap-on mounting onto 35 mm standard mounting rail



3TF20 ...-0...
3TF28 ...-0...

AC operation

										Screw terminals					
5	1.3	2.2	2.9	3.8	10E	1	--	B	3TF28 10-0AP0		1	1 unit	101	0.200	
					01E	--	1	C	3TF28 01-0AP0		1	1 unit	101	0.200	
9	2.4	4	4	4	10E	1	--	A	3TF20 10-0AP0		1	1 unit	101	0.200	
					01E	--	1	A	3TF20 01-0AP0		1	1 unit	101	0.200	

DC operation - DC solenoid system

5	1.3	2.2	2.9	3.8	10E	1	--	C	3TF28 10-0BB4		1	1 unit	101	0.220
					01E	--	1	C	3TF28 01-0BB4		1	1 unit	101	0.220
9	2.4	4	4	4	10E	1	--	A	3TF20 10-0BB4		1	1 unit	101	0.220
					01E	--	1	A	3TF20 01-0BB4		1	1 unit	101	0.220

Contactors with screw terminals 6.3 mm x 0.8 mm - for screw and snap-on mounting onto 35 mm standard mounting rail



3TF20 ...-3...

AC operation

										Flat connectors					
9	2.4	4	4	--	10E	1	--	C	3TF20 10-3AP0		1	1 unit	101	0.170	
					01E	--	1	C	3TF20 01-3AP0		1	1 unit	101	0.170	

DC operation - DC solenoid system

9	2.4	4	4	--	10E	1	--	C	3TF20 10-3BB4		1	1 unit	101	0.190
					01E	--	1	C	3TF20 01-3BB4		1	1 unit	101	0.190

Contactors with flat connectors 6.3 mm x 0.8 mm - for screw fixing (diagonal)



3TF20 ...-7...

AC operation

9	2.4	4	4	--	10E	1	--	C	3TF20 10-7AP0		1	1 unit	101	0.160
					01E	--	1	C	3TF20 01-7AP0		1	1 unit	101	0.160

DC operation - DC solenoid system

9	2.4	4	4	--	10E	1	--	C	3TF20 10-7BB4		1	1 unit	101	0.190
					01E	--	1	C	3TF20 01-7BB4		1	1 unit	101	0.190

Contactors with solder pin connections for printed circuit boards - for screw fixing (diagonal)



3TF20 ...-6...

AC operation

										Solder pin connections					
9	2.4	4	4	--	10E	1	--	C	3TF20 10-6AP0		1	1 unit	101	0.160	
					01E	--	1	C	3TF20 01-6AP0		1	1 unit	101	0.160	

DC operation - DC solenoid system

9	2.4	4	4	--	10E	1	--	C	3TF20 10-6BB4		1	1 unit	101	0.190
					01E	--	1	C	3TF20 01-6BB4		1	1 unit	101	0.190

For accessories, see page 3/119.

* You can order this quantity or a multiple thereof.

3RT, 3TB, 3TF Contactors for Switching Motors

3TF2 contactors, 3-pole, 2.2 ... 4 kW

Rated data Utilization categories AC-2 and AC-3		Auxiliary contacts		DT	Screw terminals 	PU (UNIT, SET, M)	PS*	PG	Weight per PU approx.
Operational current I_e at 400/ 380 V	Ratings of induction motors at 50 Hz and				Ident. No.	Version	Order No.	Price per PU	
	230/ 220 V	400/ 380 V	500 V	690/ 660 V					
A	kW	kW	kW	kW					kg

Contactors with permanently mounted auxiliary switch blocks with screw terminals, width 45 mm for screw and snap-on mounting onto 35 mm standard mounting rail



AC operation

5	1.3	2.2	2.9	3.8	11E	1	1	C	3TF29 11-0AP0	1	1 unit	101	0.230
					22E	2	2	C	3TF29 22-0AP0	1	1 unit	101	0.230
9	2.4	4	4	4	11E	1	1	C	3TF22 11-0AP0	1	1 unit	101	0.230
					22E	2	2	C	3TF22 22-0AP0	1	1 unit	101	0.230

DC operation · DC solenoid system

3TF22 ...-0... 3TF29 ...-0...	5	1.3	2.2	2.9	3.8	11E	1	1	C	3TF29 11-0BB4	1	1 unit	101	0.250
						22E	2	2	C	3TF29 22-0BB4	1	1 unit	101	0.250
	9	2.4	4	4	4	11E	1	1	C	3TF22 11-0BB4	1	1 unit	101	0.250
						22E	2	2	C	3TF22 22-0BB4	1	1 unit	101	0.250

For accessories, see page 3/119.

Rated control supply voltages (the 10th and 11th position of the order number must be changed)

Contactor type	3TF20, 3TF28		
Rated control supply voltage U_s			
AC operation			
Solenoid coils for AC 50 and 60 Hz			
50 Hz	60 Hz		
24 V AC	29 V AC	B0	
110 V AC	132 V AC	F0	
230/220 V AC	276 V AC	P0 ¹⁾	
AC operation			
Solenoid coils for AC 50/60 Hz			
230 V AC	L2		
DC operation			
24 V DC	B4		

Contactor type	3TF22, 3TF29	
Rated control supply voltage U_s		
AC operation		
Solenoid coils for AC 50 and 60 Hz		
50 Hz	60 Hz	
230/220 V AC	276 V AC	P0 ¹⁾
DC operation		
24 V DC	B4	

¹⁾ Operating range at 220 V:
0.85 to 1.15 x U_s ; lower operating range limit according to IEC 60947.

Please inquire about other voltages.

3RA13, 3RA14 Contactor Assemblies

3RA13 Reversing Contactor Assemblies

3RA13 complete units, 3 ... 45 kW

Overview

The 3RA13 reversing contactor assemblies can be ordered as follows:

Sizes S00 to S3

- Fully wired and tested, with mechanical and electrical interlock. For assemblies with AC operation and 50/60 Hz, a dead interval of 50 ms must be provided when used with voltages ≥ 500 V; a dead interval of 30 ms is recommend for use with voltages ≥ 400 V. These dead times do not apply to assemblies with DC operation.

Sizes S00 to S12

- As individual parts for customer assembly.

There is also a range of accessories (auxiliary switch blocks, surge suppressors, etc.) that must be ordered separately.

For overload relays for motor protection, see "Protection Equipment --> Overload Relays".

The 3RA13 contactor assemblies have screw terminals and are suitable for screw or snap-on mounting onto 35 mm standard mounting rails.

Complete units

The fully wired reversing contactor assemblies are suitable for use in any climate. They are finger-safe according to EN 50274.

The contactor assemblies consist of 2 contactors with the same power, with one NC contact in the basic unit. The contactors are mechanically and electrically interlocked (NC contact interlock).

For motor protection, either 3RU11 or 3RB2. overload relays for direct mounting or stand-alone installation or thermistor motor protection tripping units must be ordered separately.

Components for customer assembly

Assembly kits for all sizes are available for customer assembly of reversing contactor assemblies.

Contactors, overload relays, the mechanical interlock (as of size S0) and – for momentary-contact operation – auxiliary switch blocks for latching must be ordered separately.

Rated data AC-2 and AC-3 at 50 Hz 400 V AC		Size	Order No.				Assembly kit	Fully wired and tested contactor assemblies
Rating kW	Operational current I_e A		Contactor	Mechanical interlock ¹⁾	Mechanical interlock ²⁾	Mechanical interlock ³⁾		
3	7	S00	3RT10 15	-- ⁴⁾	--	--	3RA19 13-2A ⁵⁾	3RA13 15-8XB30-1 ..
4	9		3RT10 16					3RA13 16-8XB30-1 ..
5.5	12		3RT10 17					3RA13 17-8XB30-1 ..
5.5	12	S0	3RT10 24	3RA19 24-1A	3RA19 24-2B	--	3RA19 23-2A ⁶⁾	3RA13 24-8XB30-1 ..
7.5	17		3RT10 25					3RA13 25-8XB30-1 ..
11	25		3RT10 26					3RA13 26-8XB30-1 ..
15	32	S2	3RT10 34	3RA19 24-1A	3RA19 24-2B	--	3RA19 33-2A ⁷⁾	3RA13 34-8XB30-1 ..
18.5	40		3RT10 35					3RA13 35-8XB30-1 ..
22	50		3RT10 36					3RA13 36-8XB30-1 ..
30	65	S3	3RT10 44	3RA19 24-1A	3RA19 24-2B	--	3RA19 43-2A ⁷⁾	3RA13 44-8XB30-1 ..
37	80		3RT10 45					3RA13 45-8XB30-1 ..
45	95		3RT10 46					3RA13 46-8XB30-1 ..
55	115	S6	3RT10 54	--	--	3RA19 54-2A	3RA19 53-2M ⁸⁾	--
75	150		3RT10 55					
90	185		3RT10 56					
110	225	S10	3RT10 64	--	--	3RA19 54-2A	3RA19 63-2A ⁸⁾	--
132	265		3RT10 65					
160	300		3RT10 66					
200	400	S12	3RT10 75	--	--	3RA19 54-2A	3RA19 73-2A ⁸⁾	--
250	500		3RT10 76					

1) Can be mounted onto the front.

2) Laterally mountable with one auxiliary contact.

3) Laterally mountable without auxiliary contact.

4) Interlock can only be ordered with assembly kit.

5) Assembly kit contains: mechanical interlock; connecting clips for 2 contactors; wiring modules on the top and bottom.

6) Assembly kit contains: wiring modules on the top and bottom.

7) Assembly kit contains: 2 connecting clips for contactors; wiring modules on the top and bottom.

8) Assembly kit contains: wiring module on the top and bottom.

3RA13, 3RA14 Contactor Assemblies

3RA13 Reversing Contactor Assemblies

3RA13 complete units, 3 ... 45 kW

Selection and ordering data

Fully wired and tested contactor assemblies²⁾ · Size S00 · up to 5.5 kW

Rated data AC-2 and AC-3		Rated control supply voltage U_s ¹⁾		DT	Screw terminals	⊕	PU (UNIT, SET, M)	PS*	PG	Weight per PU approx.
Operational current I_e up to	Ratings of induction motors at 50 Hz and				A	Order No.	Price per PU			kg
	400 V	230 V	400 V	500 V						
A	kW	kW	kW	kW	V					

AC operation, 50/60 Hz



3RA13 1..-8XB30-1...

7	2.2	3	3.5	4	24 AC	A	3RA13 15-8XB30-1AB0	1	1 unit	101	0.430
					110 AC	A	3RA13 15-8XB30-1AF0	1	1 unit	101	0.430
					230 AC	▶	3RA13 15-8XB30-1AP0	1	1 unit	101	0.430
9	3	4	4.5	5.5	24 AC	A	3RA13 16-8XB30-1AB0	1	1 unit	101	0.430
					110 AC	A	3RA13 16-8XB30-1AF0	1	1 unit	101	0.430
					230 AC	▶	3RA13 16-8XB30-1AP0	1	1 unit	101	0.430
12	3	5.5	5.5	5.5	24 AC	A	3RA13 17-8XB30-1AB0	1	1 unit	101	0.430
					110 AC	A	3RA13 17-8XB30-1AF0	1	1 unit	101	0.430
					230 AC	▶	3RA13 17-8XB30-1AP0	1	1 unit	101	0.430

DC operation

7	2.2	3	3.5	4	24 DC	▶	3RA13 15-8XB30-1BB4	1	1 unit	101	0.550
9	3	4	4.5	5.5	24 DC	▶	3RA13 16-8XB30-1BB4	1	1 unit	101	0.550

¹⁾ Coil operating range at 50 Hz: 0.8 ... 1.1 x U_s ; at 60 Hz: 0.85 ... 1.1 x U_s .

²⁾ The contactors integrated in the contactor assemblies have no unassigned auxiliary contacts.

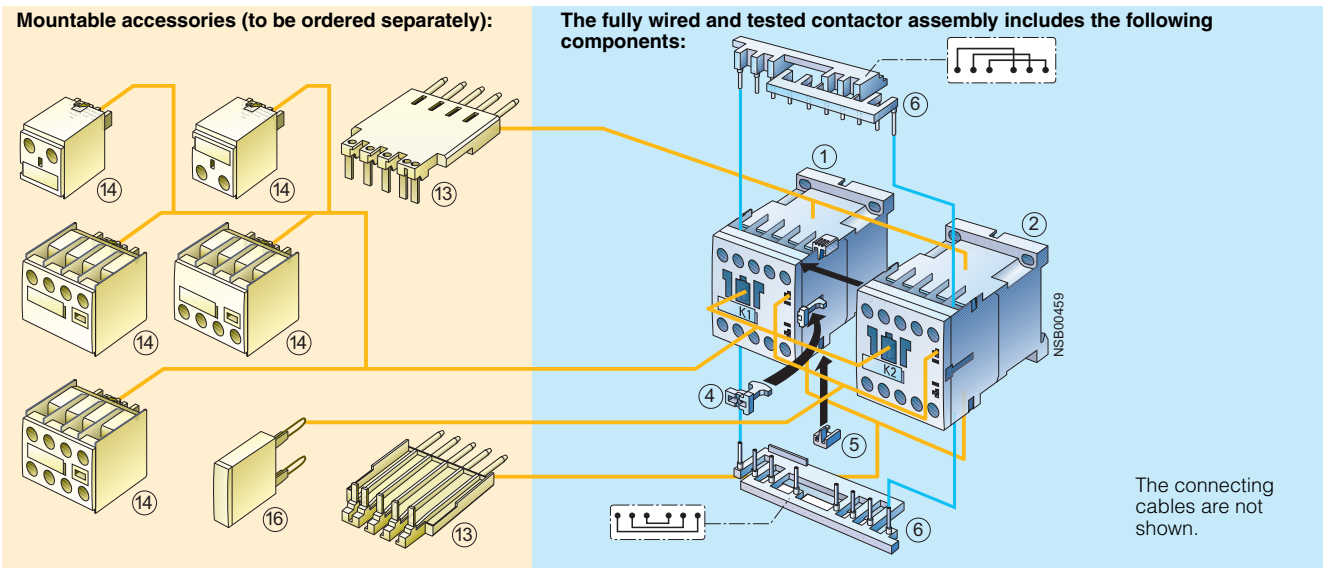

The connecting cables are not shown.

Accessories	Order No.	Page	Individual parts	Order No. K1	K2	Page
13 Solder pin adapters	3RT19 16-4KA1	3/110	1 2 Contactors, 3 kW	3RT10 15	3RT10 15	3/15
14 Auxiliary switch block, front	3RH19 11-1....	3/100	1 2 Contactors, 4 kW	3RT10 16	3RT10 16	3/15
(auxiliary switch block according to EN 50005 must be used)			1 2 Contactors, 5.5 kW	3RT10 17	3RT10 17	3/15
16 Surge suppressors	3RT19 16-1....	3/107, 3/108	4 5 6 Assembly kit	3RA19 13-2A		3/38
			The assembly kit contains:			
			4 Mechanical interlock			
			5 2 connecting clips for 2 contactors			
			6 Wiring modules on the top and bottom for connecting the main current paths, electrical interlock included ¹⁾ , interruptible (NC contact interlock)			

¹⁾ 3RT10 1. contactors with one NC contact in the basic unit are required for the electrical interlock.

3RA13, 3RA14 Contactor Assemblies

3RA13 Reversing Contactor Assemblies

3RA13 complete units, 3 ... 45 kW

Fully wired and tested contactor assemblies · Size S0 · up to 11 kW



3RA13 2...8XB30-1...

Rated data AC-2 and AC-3					Rated control supply voltage U_s 1)	DT	Screw terminals		PU (UNIT, SET, M)	PS*	PG	Weight per PU approx.
Operational current I_e up to 400 V	Ratings of induction motors at 50 Hz and						Order No.	Price per PU				
	230 V	400 V	500 V	690 V								
A	kW	kW	kW	kW	V						kg	
AC operation, 50/60 Hz												
12	3	5.5	7.5	7.5	24 AC	A	3RA13 24-8XB30-1AC2		1	1 unit	101	0.770
					110 AC	A	3RA13 24-8XB30-1AG2		1	1 unit	101	0.770
					230 AC	A	3RA13 24-8XB30-1AL2		1	1 unit	101	0.770
17	4	7.5	10	11	24 AC	A	3RA13 25-8XB30-1AC2		1	1 unit	101	0.770
					110 AC	A	3RA13 25-8XB30-1AG2		1	1 unit	101	0.770
					230 AC	A	3RA13 25-8XB30-1AL2		1	1 unit	101	0.770
25	5.5	11	11	11	24 AC	A	3RA13 26-8XB30-1AC2		1	1 unit	101	0.770
					110 AC	A	3RA13 26-8XB30-1AG2		1	1 unit	101	0.770
					230 AC	A	3RA13 26-8XB30-1AL2		1	1 unit	101	0.770
DC operation												
12	3	5.5	7.5	7.5	24 DC	A	3RA13 24-8XB30-1BB4		1	1 unit	101	1.230
17	4	7.5	10	11	24 DC	A	3RA13 25-8XB30-1BB4		1	1 unit	101	1.230
25	5.5	11	11	11	24 DC	A	3RA13 26-8XB30-1BB4		1	1 unit	101	1.230

1) Coil operating range at 50 Hz: 0.8 ... 1.1 x U_s ; at 60 Hz: 0.85 ... 1.1 x U_s .

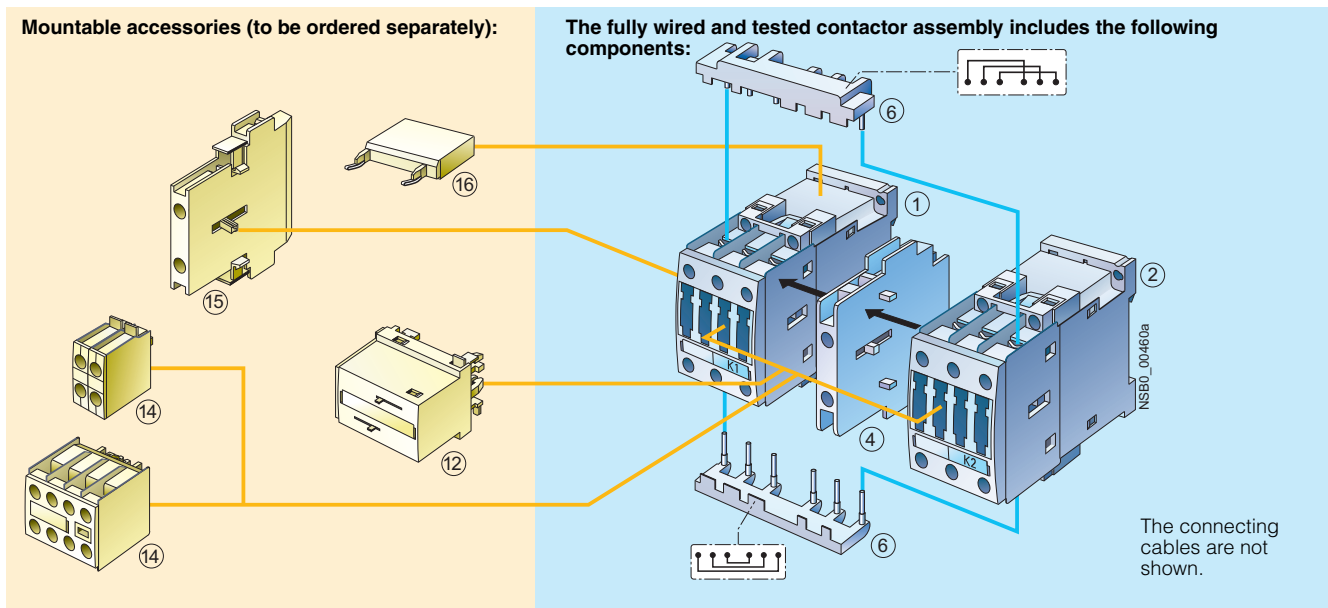

Accessories	Order No.	Page	Individual parts	Order No. K1	K2	Page
12 Mechanical interlock, front	3RA19 24-1A	3/37	1 2 Contactors, 5.5 kW	3RT10 24	3RT10 24	3/16
14 Auxiliary switch block, front	3RH19 21-1CA...	3/101	1 2 Contactors, 7.5 kW	3RT10 25	3RT10 25	3/16
15 Auxiliary switch block, lateral	3RH19 21-1EA...	3/103	1 2 Contactors, 11 kW	3RT10 26	3RT10 26	3/16
16 Surge suppressors	3RT19 26-1....	3/107	4 Mechanical interlock, lateral	3RA19 24-2B		3/37
			6 Assembly kit	3RA19 23-2A		3/38

The assembly kit contains wiring modules on the top and bottom (they also form the mechanical connection between the contactors).

* You can order this quantity or a multiple thereof.

3RA13, 3RA14 Contactor Assemblies

3RA13 Reversing Contactor Assemblies

3RA13 complete units, 3 ... 45 kW

Fully wired and tested contactor assemblies · Size S2 · up to 22 kW



3RA13 3...8XB30-1...

Rated data AC-2 and AC-3		Rated control supply voltage U_s 1)		DT	Screw terminals	⊕	PU (UNIT, SET, M)	PS*	PG	Weight per PU approx.	
Operational current I_e up to 500 V	Ratings of induction motors at 50 Hz and				24 AC 110 AC 230 AC	A	Order No.	Price per PU			
	230 V	400 V	500 V	690 V							
A	kW	kW	kW	kW	V					kg	
AC operation, 50/60 Hz											
32	7.5	15	18.5	18.5	24 AC	A	3RA13 34-8XB30-1AC2	1	1 unit	101	2,300
					110 AC	A	3RA13 34-8XB30-1AG2	1	1 unit	101	2,300
					230 AC	A	3RA13 34-8XB30-1AL2	1	1 unit	101	2,300
40	11	18.5	22	22	24 AC	A	3RA13 35-8XB30-1AC2	1	1 unit	101	2,300
					110 AC	A	3RA13 35-8XB30-1AG2	1	1 unit	101	2,300
					230 AC	A	3RA13 35-8XB30-1AL2	1	1 unit	101	2,300
50	15	22	30	22	24 AC	B	3RA13 36-8XB30-1AC2	1	1 unit	101	2,300
					110 AC	B	3RA13 36-8XB30-1AG2	1	1 unit	101	2,300
					230 AC	A	3RA13 36-8XB30-1AL2	1	1 unit	101	2,300
DC operation											
32	7.5	15	18.5	18.5	24 DC	A	3RA13 34-8XB30-1BB4	1	1 unit	101	3,450
40	11	18.5	22	22	24 DC	A	3RA13 35-8XB30-1BB4	1	1 unit	101	3,450
50	15	22	30	22	24 DC	A	3RA13 36-8XB30-1BB4	1	1 unit	101	3,450

1) Coil operating range at 50 Hz: 0.8 ... 1.1 x U_s ; at 60 Hz: 0.85 ... 1.1 x U_s .

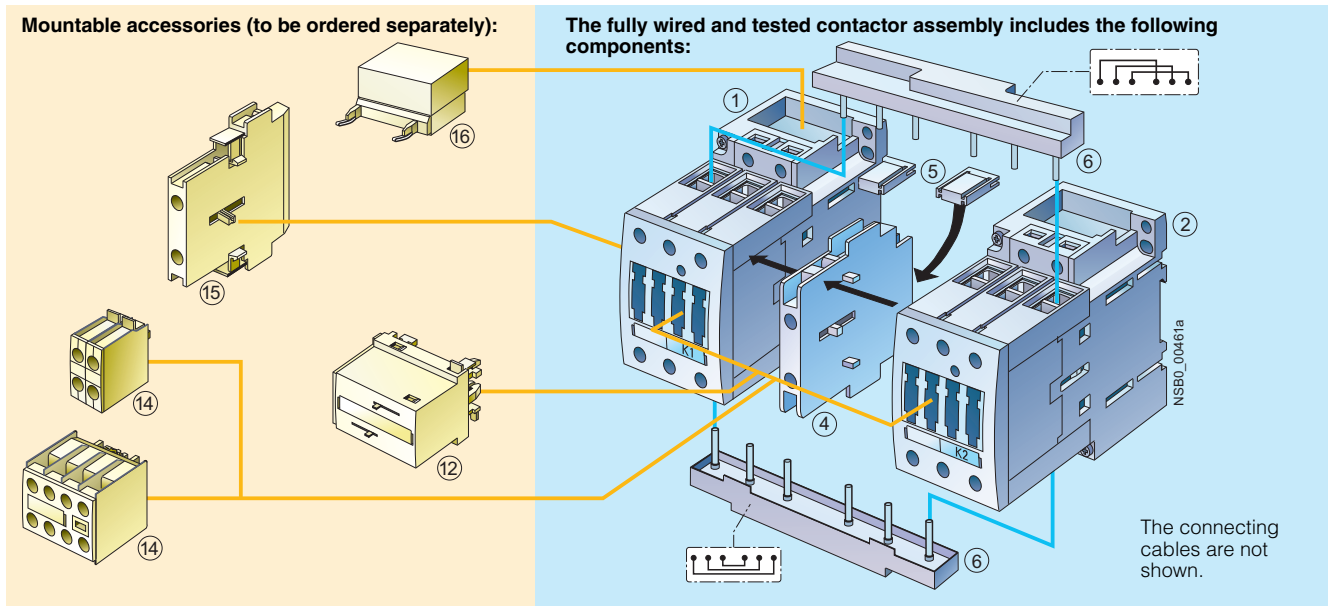

Accessories	Order No.	Page	Individual parts	Order No.	Page
12 Mechanical interlock, front	3RA19 24-1A	3/37	1 2 Contactors, 15 kW	K1 3RT10 34	K2 3RT10 34 3/17
14 Auxiliary switch block, front	3RH19 21-1CA..	3/101	1 2 Contactors, 18.5 kW	3RT10 35	3RT10 35 3/17
15 Auxiliary switch block, lateral	3RH19 21-1EA..	3/103	1 2 Contactors, 22 kW	3RT10 36	3RT10 36 3/17
16 Surge suppressors	3RT19 26-1.... 3RT19 36-1....	3/107	4 Mechanical interlock, lateral	3RA19 24-2B	3/37
			5 6 Assembly kit	3RA19 33-2A	3/38
			The assembly kit contains:		
			5 2 connecting clips for 2 contactors with a clearance of 10 mm		
			6 Wiring modules on the top and bottom for connecting the main current paths		

3RA13, 3RA14 Contactor Assemblies

3RA13 Reversing Contactor Assemblies

3RA13 complete units, 3 ... 45 kW

Fully wired and tested contactor assemblies · Size S3 · up to 45 kW



3RA13 4.-8XB30-1...

Rated data AC-2 and AC-3						Rated control supply voltage U_s 1)	DT	Screw terminals		PU (UNIT, SET, M)	PS*	PG	Weight per PU approx.
Operational current I_e up to 500 V	Ratings of induction motors at 50 Hz and							Order No.	Price per PU				
	230 V	400 V	500 V	690 V	V								
AC operation at 50/60 Hz													
65	18.5	30	37	45	24 AC	B	3RA13 44-8XB30-1AC2		1	1 unit	101	4,500	
					110 AC	B	3RA13 44-8XB30-1AG2		1	1 unit	101	4,500	
					230 AC	B	3RA13 44-8XB30-1AL2		1	1 unit	101	4,500	
80	22	37	45	55	24 AC	B	3RA13 45-8XB30-1AC2		1	1 unit	101	4,500	
					110 AC	B	3RA13 45-8XB30-1AG2		1	1 unit	101	4,500	
					230 AC	B	3RA13 45-8XB30-1AL2		1	1 unit	101	4,500	
95	22	45	55	55	24 AC	B	3RA13 46-8XB30-1AC2		1	1 unit	101	4,500	
					110 AC	B	3RA13 46-8XB30-1AG2		1	1 unit	101	4,500	
					230 AC	B	3RA13 46-8XB30-1AL2		1	1 unit	101	4,500	
DC operation													
65	18.5	30	37	45	24 DC	B	3RA13 44-8XB30-1BB4		1	1 unit	101	6,500	
80	22	37	45	55	24 DC	B	3RA13 45-8XB30-1BB4		1	1 unit	101	6,500	
95	22	45	55	55	24 DC	B	3RA13 46-8XB30-1BB4		1	1 unit	101	6,500	

1) Coil operating range at 50 Hz: 0.8 ... 1.1 x U_s ; at 60 Hz: 0.85 ... 1.1 x U_s .

Mountable accessories (to be ordered separately):

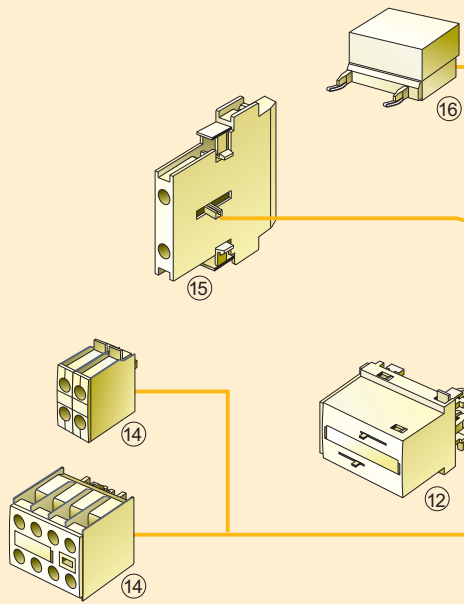

The fully wired and tested contactor assembly includes the following components:

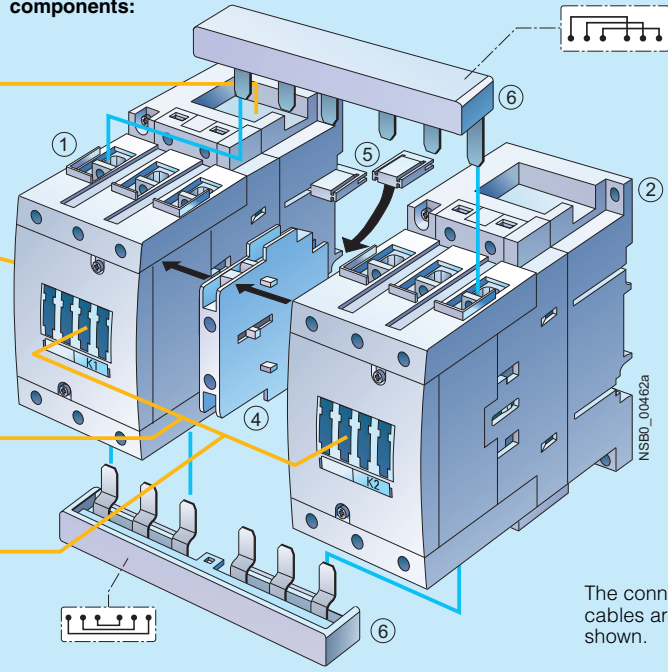

The connecting cables are not shown.

Accessories	Order No.	Page	Individual parts	Order No. K1	Order No. K2	Page
12 Mechanical interlock, front	3RA19 24-1A	3/37	1 2 Contactors, 30 kW	3RT10 44	3RT10 44	3/18
14 Auxiliary switch block, front	3RH19 21-1CA...	3/101	1 2 Contactors, 37 kW	3RT10 45	3RT10 45	3/18
15 Auxiliary switch block, lateral	3RH19 21-1EA...	3/103	1 2 Contactors, 45 kW	3RT10 46	3RT10 46	3/18
16 Surge suppressors	3RT19 26-1... 3RT19 36-1...	3/107	4 Mechanical interlock, lateral	3RA19 24-2B		3/37
			5 6 Assembly kit	3RA19 43-2A		3/38
The assembly kit contains:						
			5 2 connecting clips for 2 contactors with a clearance of 10 mm			
			6 Wiring modules on the top and bottom for connecting the main current paths			



* You can order this quantity or a multiple thereof.

3RA13, 3RA14 Contactor Assemblies

3RA13 Reversing Contactor Assemblies

Components for customer assembly

Selection and ordering data

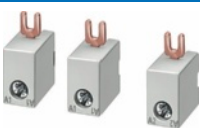
For contactors	Size	Version	DT	Order No.	Price per PU	PU (UNIT, SET, M)	PS*	PG	Weight per PU approx. kg
Mechanical interlocks									
 <p>3RA19 24-1A mounted onto 2 contactors</p>	3RT10 2	S0	For lateral mounting¹⁾ Each with one auxiliary contact (1 NC contact) per contactor (can only be used to connect contactors which are not more than 1 size larger or smaller. The mounting depth of the smaller contactor has to be adapted.)	▶	3RA19 24-2B	1	1 unit	101	0.060
	3RT10 3	S2							
	3RT10 4	S3							
	3RT13 2								
	3RT13 3								
	3RT13 4								
3RT14 4									
3RT15 2									
3RT15 3									
 <p>3RA19 54-2A</p>	3RT10 2	S0	For mounting to the front²⁾ Onto contactors with sizes S0 to S3 (for contactors of the same size) <i>Note:</i> <i>Size S0: Wiring modules must be mounted first. Sizes S2 and S3: Use 3RA19 32-2C mechanical connectors.</i>	▶	3RA19 24-1A	1	1 unit	101	0.050
	3RT10 3	S2							
	3RT10 4	S3							
	3RT13 2	S0							
	3RT15 2								
3RT1. 5 to 3RT1. 7	S6 S10 S12	For lateral mounting Without auxiliary contacts; size S6, S10 and S12 contactors can be interlocked with each other as required; no adaptation of mounting depth is necessary. Contactor clearance 10 mm.	▶	3RA19 54-2A	1	1 unit	101	0.050	
 <p>3RA19 54-2C</p>	3RT10 4.-A with 3RT10 5	S3 with S6	Adapters, laterally mountable For mechanical interlocking of contactor S3 (only for AC operation) with contactor S6 using 3RA19 54-2A locking device (must be ordered separately) incl. connecting clips	A	3RA19 54-2C	1	1 unit	101	0.050
	Coil repeat terminals								
 <p>3RA19 23-3B</p>	3RT10 3	S2, S3	For the coil terminals A1 and A2 for reversing starters (contactor sizes S2 and S3). 2 x A1 and 1 x A2 required per assembly (one set contains 10 x A1 and 5 x A2)	B	3RA19 23-3B	1	1 unit	101	0.080
	3RT10 4								
Base plates									
	3RT10 5	S6	For customer assembly of reversing contactor assemblies	B	3RA19 52-2A	1	1 unit	101	1.300
	3RT1. 6	S10		B	3RA19 62-2A	1	1 unit	101	2.100
	3RT1. 7	S12		B	3RA19 72-2A	1	1 unit	101	2.300

¹⁾ Can also be used for 4-pole contactors with sizes S2 and S3.

²⁾ Can also be used for size S0 4-pole contactors.

3RA13, 3RA14 Contactor Assemblies

3RA13 Reversing Contactor Assemblies

Components for customer assembly

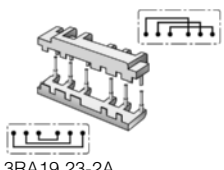
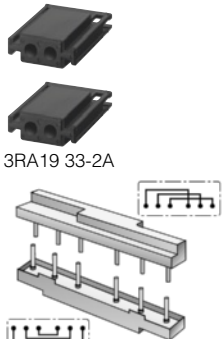
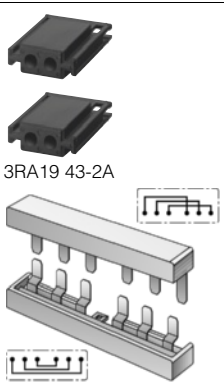
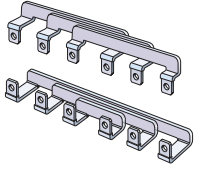
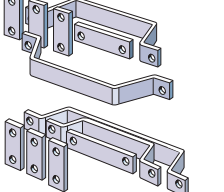
Type	For contactors	Size	Version	DT	Order No.	Price per PU	PU (UNIT, SET, M)	PS*	PG	Weight per PU approx. kg
Assembly kits for making 3-pole contactor assemblies										
 <p>3RA19 13-2A</p>	3RT10 1	S00	The assembly kit contains: ▶ mechanical interlock; 2 connecting clips for 2 contactors; wiring modules on the top and bottom		3RA19 13-2A		1	1 unit	101	0.040
 <p>3RA19 23-2A</p>	3RT10 2	S0	The assembly kit contains: ▶ wiring modules on the top and bottom		3RA19 23-2A		1	1 unit	101	0.060
 <p>3RA19 33-2A</p>	3RT10 3	S2	The assembly kit contains: ▶ 2 connecting clips for 2 contactors; wiring modules on the top and bottom		3RA19 33-2A		1	1 unit	101	0.120
 <p>3RA19 43-2A</p>	3RT10 4	S3	The assembly kit contains: ▶ 2 connecting clips for 2 contactors; wiring modules on the top and bottom		3RA19 43-2A		1	1 unit	101	0.300
 <p>3RA19 53-2A</p>	3RT10 5	S6	The assembly kit contains: A Wiring modules on the top and bottom (for connection with box terminal)		3RA19 53-2A		1	1 unit	101	1.300
 <p>3RA19 53-2M 3RA19 63-2A 3RA19 73-2A</p>	3RT10 5 3RT1. 6 3RT1. 7	S6 S10 S12	The assembly kit contains: A Wiring modules on the top and bottom (for connection without box terminal)		3RA19 53-2M 3RA19 63-2A 3RA19 73-2A		1 1 1	1 unit 1 unit 1 unit	101 101 101	0.900 2.400 3.000

* You can order this quantity or a multiple thereof.

3RA13, 3RA14 Contactor Assemblies

3RA13 Reversing Contactor Assemblies

Components for customer assembly

For contactors	Size	Contact-clearance	Version	DT	Order No.	Price per PU	PU (UNIT, SET, M)	PS*	PG	Weight per PU approx.
Type		mm								kg
Wiring modules, single										
3RT10 1	S00-S00	0	Top (in-phase)	▶	3RA19 13-3D		1	5 units	101	0.015
			Bottom (with phase reversal)	▶	3RA19 13-3E					
3RT10 2	S0-S0 and S0-S0	0 and 10	Top (in-phase)	▶	3RA19 23-3D		1	5 units	101	0.020
			Bottom (with phase reversal)	▶	3RA19 23-3E					
3RT10 3	S2-S2	10	Top (in-phase)	▶	3RA19 33-3D		1	1 unit	101	0.065
			Bottom (with phase reversal)	▶	3RA19 33-3E					
3RT10 4	S3-S3	10	Top (in-phase)	▶	3RA19 43-3D		1	1 unit	101	0.160
			Bottom (with phase reversal)	▶	3RA19 43-3E					
3RT10 5	S6-S6	10	Top (in-phase, for connection with box terminal)	A	3RA19 53-3D		1	1 unit	101	0.620
			Top (with phase reversal, for connection without box terminal)	A	3RA19 53-3P					

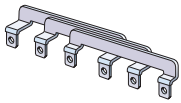

3RA19 53-3D

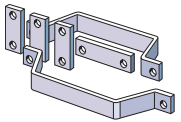

3RA19 53-3P

For contactors	Size	Contact-clearance	Interlocking	Version	DT	Order No.	Price per PU	PU (UNIT, SET, M)	PS*	PG	Weight per PU approx.
Type		mm									kg
Mechanical connectors						1 pack = 10 sets for 10 assemblies					
3RT1. 1 ¹⁾	S00-S00	0	Laterally mountable	For 3- and 4-pole contactors	▶	3RA19 12-2H		1	10 units	101	0.010
3RT1. 2	S0-S0	0 10 ²⁾	Mountable on front	For 3- and 4-pole contactors	A	3RA19 22-2C		1	10 units	101	0.025
					▶	3RT19 22-2D					
3RT1. 3	S2-S2	0	Mountable on front	For 3-pole contactors	▶	3RA19 32-2C		1	10 units	101	0.010
3RT1. 4	S3-S3										
3RT1. 3	S2-S2	10	Laterally mountable	For 3-pole contactors	▶	3RA19 32-2D		1	10 units	101	0.010
3RT1. 4	S3-S3										
3RT1. 5	S6-S6										
3RT1. 3	S2-S2	10	Laterally mountable	For 4-pole contactors	A	3RA19 32-2G		1	10 units	101	0.010
3RT1. 4	S3-S3	10	Laterally mountable	For 4-pole contactors	B	3RA19 42-2G		1	10 units	101	0.010



3RA19 12-2H



3RA19 22-2C



3RA19 32-2C



3RA19 32-2D



3RA19 32-2G



3RA19 42-2G

1) This pack contains 10 additional interlocks.

2) The connector function can be fulfilled with the wiring modules for size S0, a contactor clearance of 10 mm and a lateral interlock.

3RA13, 3RA14 Contactor Assemblies

3RA14 Contactor Assemblies for Wye-Delta Starting

3RA14 complete units, 3 ... 75 kW

Overview

These 3RA14 contactor assemblies for wye-delta starting are designed for standard applications.

Note:

Contactor assemblies for wye-delta starting in special applications such as very heavy starting or wye-delta starting of special motors must be customized. Help with designing such special applications is available from Technical Assistance.

The 3RA14 contactor assemblies for wye-delta starting can be ordered as follows:

Sizes S00 to S3:

- Fully wired and tested, with electrical interlock, dead interval of up to 10 s on reversing (size S00 with electrical and mechanical interlocks)

Sizes S00 to S12:

- As individual parts for customer assembly.

A dead interval of 50 ms on reversing is already integrated in the time relay function.

There is also a range of accessories (auxiliary switch blocks, surge suppressors, etc.) that must be ordered separately.

For overload relays for motor protection see "Protection Equipment --> Overload Relays --> 3RB2 Solid-State Overload Relays".

The 3RA14 contactor assemblies have screw terminals and are suitable for screw or snap-on mounting onto 35 mm standard mounting rails.

Fully wired and tested 3RA14 contactor assemblies have one unassigned NO contact which is mounted onto the front of the K3 delta contactor.

A solid-state time-delay auxiliary switch block is snapped onto the front of the complete contactor assemblies, size S00 up to 7.5 kW, while a timing relay is mounted onto the side of sizes S0 to S3, 11 kW to 75 kW.

Rated data at AC 50 Hz 400 V			Size			Accessories for customer assembly		
Rating kW	Operational current I_e A	Motor current A		Line/delta contactor	Star contactor	Order No. complete	Timing relay	Assembly kit A, for double infeed
5.5	12	9.5 ... 13.8	S00-S00-S00	3RT10 15	3RT10 15	3RA14 15-8XB31-1...	3RT19 16-2G.51	--
7.5	17	12.1 ... 17		3RT10 17		3RA14 16-8XB31-1...	3RP15 74-1N.30	
11	25	19 ... 25	S0-S0-S0	3RT10 24	3RT10 24	3RA14 23-8XC21-1...	3RP15 74-1N.30	--
15	32	24.1 ... 34		3RT10 26		3RA14 25-8XC21-1...		
18.5	40	34.5 ... 40						
22	50	31 ... 43	S2-S2-S0	3RT10 34	3RT10 26	3RA14 34-8XC21-1...	3RP15 74-1N.30	3RA19 33-2C ³⁾
30	50	48.3 ... 65		3RT10 35		--		
37	80	62.1 ... 77.8	S2-S2-S2		3RT10 34	3RA14 35-8XC21-1...		3RA19 33-2B ³⁾
45	86	69 ... 86		3RT10 36		3RA14 36-8XC21-1...		
55	115	77.6 ... 108.6	S3-S3-S2	3RT10 44	3RT10 35	3RA14 44-8XC21-1...	3RP15 74-1N.30	3RA19 43-2C ³⁾
75	150	120.7 ... 150		3RT10 45	3RT10 36	3RA14 45-8XC21-1...		
90	160	86 ... 160	S6-S6-S3	3RT10 54	3RT10 44	--	3RP15 74-1N.30	--
110	195	86 ... 195						
132	230	86 ... 230		3RT10 55	3RT10 45			
160	280	86 ... 280		3RT10 56	3RT10 46			
200	350	95 ... 350	S10-S10-S6	3RT10 64	3RT10 54	--	3RP15 74-1N.30	--
250	430	95 ... 430		3RT10 65	3RT10 55			
315	540	277 ... 540	S12-S12-S10	3RT10 75	3RT10 64	--	3RP15 74-1N.30	--
355	610	277 ... 610						
400	690	277 ... 690			3RT10 65			
500	850	277 ... 850		3RT10 76	3RT10 66			

¹⁾ Assembly kit contains mechanical interlock, 3 connecting clips; wiring modules on the top (connection between line and delta contactor) and on the bottom (connection between delta and star contactor); star jumper.

²⁾ Assembly kit contains 5 connecting clips; wiring modules on the top (connection between line and delta contactor) and on the bottom (connection between delta and star contactor); star jumper.

³⁾ Assembly kit contains wiring module on the bottom (connection between delta and star contactor) and star jumper.

⁴⁾ Wiring module on top from reversing contactor assembly (note conductor cross-sections).

3RA13, 3RA14 Contactor Assemblies

3RA14 Contactor Assemblies for Wye-Delta Starting

3RA14 complete units, 3 ... 75 kW

Components for customer assembly

Assembly kits with wiring modules and, if necessary, mechanical connectors are available for contactor assemblies for wye-delta starting. Contactors, overload relays, wye-delta timing relays, auxiliary switches for electrical interlock – if required also feeder terminals, mechanical interlocks (exception: In the case of the assembly kit for size S00 contactor assemblies the mechanical interlock between the delta contactor and the star contactor is included in the kit) and base plates – must be ordered separately.

The wiring kits for sizes S00 and S0 contain the top and bottom main conducting path connections between the line and delta contactors (top) and between the delta and star contactors (bottom).

In the case of sizes S2 to S12 only the bottom main conducting path connection between the delta and star contactors is included in the wiring module, owing to the larger conductor cross-section at the infeed.

Motor protection

Overload relays or thermistor motor protection tripping units can be used for overload protection.

The overload relay can be either mounted onto the line contactor or separately fitted. It must be set to 0.58 times the rated motor current.

Note:

The selection of contactor types refers to fused configurations (see Technical Information LV 1 T).

3

	Assembly kit B, for single infeed	Star jumper	Base plates	Overload relay, thermal (trip class CLASS 10)		Overload relay, solid-state (trip class CLASS 10)	
				Setting range	Order No.	Setting range	Order No.
				A		A	
	3RA19 13-2B ¹⁾	3RT19 16-4BA31	--	5.5 ... 8 7 ... 10	3RU11 16-1HB0 3RU11 16-1JB0	3 ... 12	3RB20 16-1SB0
	3RA19 23-2B ²⁾	3RT19 26-4BA31	--	11 ... 16 14 ... 20 20 ... 25	3RU11 26-4AB0 3RU11 26-4BB0 3RU11 26-4DB0	6 ... 25	3RB20 26-1QB0
	3RV19 35-1A	3RT19 26-4BA31	3RA19 32-2E	18 ... 25 28 ... 40	3RU11 36-4DB0 3RU11 36-4FB0	12.5 ... 50	3RB20 36-1UB0
		3RT19 36-4BA31	3RA19 32-2F	36 ... 45 40 ... 50	3RU11 36-4GB0 3RU11 36-4HB0		
	--	3RT19 36-4BA31	3RA19 42-2E	45 ... 63 70 ... 90	3RU11 46-4JB0 3RU11 46-4LB0	25 ... 100	3RB20 46-1EB0
	3RA19 53-3D ⁴⁾	3RT19 46-4BA31	3RA19 52-2E	--	--	50 ... 200	3RB20 56-1FC2
	--	3RT19 56-4BA31	3RA19 62-2E	--	--	55 ... 250	3RB20 66-1GC2
	--	3RT19 66-4BA31	3RA19 72-2E	--	--	160 ... 630	3RB20 66-1MC2

For footnotes, see page 3/40.

3RA13, 3RA14 Contactor Assemblies

3RA14 Contactor Assemblies for Wye-Delta Starting

3RA14 complete units, 3 ... 75 kW

Selection and ordering data

Fully wired and tested contactor assemblies · Size S00-S00-S00 · up to 7.5 kW



3RA14 1.-8XB31-1...

Rated data AC-3		Rated control supply voltage U_s ¹⁾		DT	Screw terminals	PU (UNIT, SET, M)	PS*	PG	Weight per PU approx.		
Operational current I_e at	Ratings of induction motors at 50 Hz and				A	Order No.	Price per PU		kg		
	400 V	230 V	400 V	500 V						690 V	
A	kW	kW	kW	kW	V						
AC operation, 50/60 Hz											
12	3.3	5.5	7.2	9.2	24 AC	C	3RA14 15-8XB31-1AB0	1	1 unit	101	0.950
					110 AC	C	3RA14 15-8XB31-1AF0	1	1 unit	101	0.950
					230 AC	C	3RA14 15-8XB31-1AP0	1	1 unit	101	0.950
17	4.7	7.5	10.3	9.2	24 AC	B	3RA14 16-8XB31-1AB0	1	1 unit	101	0.990
					110 AC	B	3RA14 16-8XB31-1AF0	1	1 unit	101	0.990
					230 AC	B	3RA14 16-8XB31-1AP0	1	1 unit	101	0.990
DC operation											
12	3.3	5.5	7.2	9.2	24 DC	B	3RA14 15-8XB31-1BB4	1	1 unit	101	1.120
17	4.7	7.5	10.3	9.2	24 DC	B	3RA14 16-8XB31-1BB4	1	1 unit	101	1.120

¹⁾ Coil operating range at 50 Hz: 0.8 ... 1.1 x U_s ; at 60 Hz: 0.85 ... 1.1 x U_s .

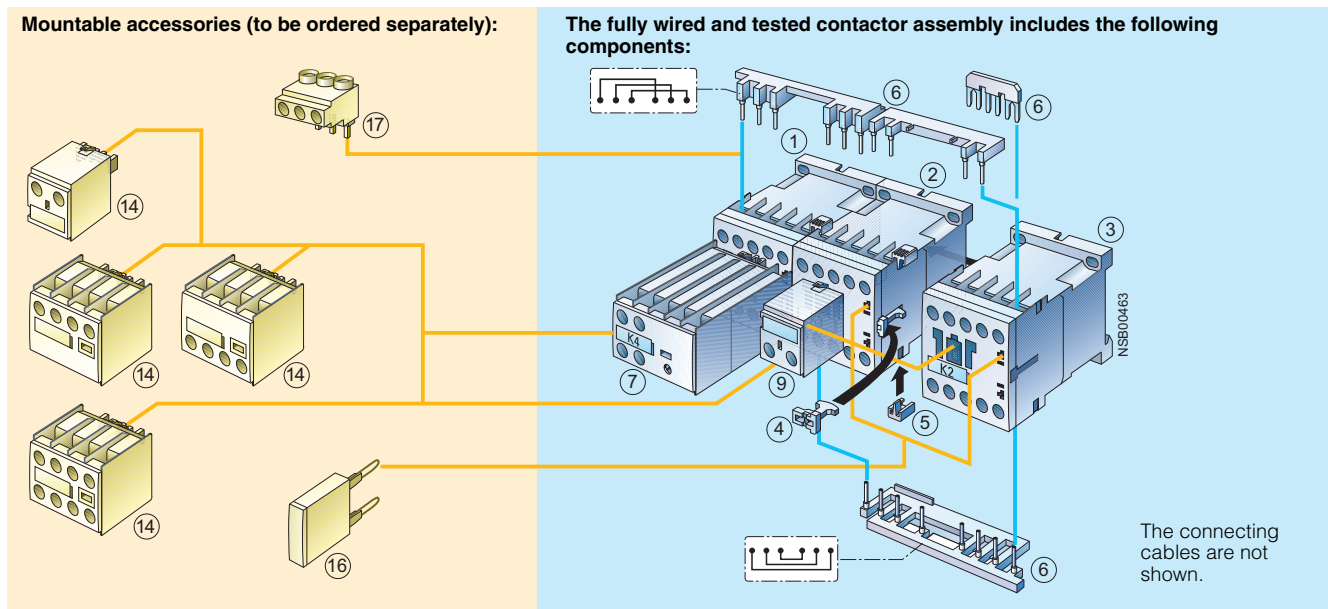

Accessories	Order No.	Page	Individual parts	Order No.			Page
				K1 ¹⁾	K3 ²⁾	K2 ²⁾	
14 Auxiliary switch block, front	3RH19 11-1...	3/100	1 2 3 Contactors, 5.5 kW	3RT10 15	3RT10 15	3RT10 15	3/15
16 Surge suppressors	3RT19 16-1...	3/107, 3/108	1 2 3 Contactors, 7.5 kW	3RT10 17	3RT10 17	3RT10 15	3/15
17 3-phase feeder terminals	3RA19 13-3K	3/47	7 Solid-state time-delay auxiliary switch block, front	3RT19 16-2G.51			3/105
			9 Auxiliary switch block with 1 unassigned NO contact	3RH19 11-1BA10			3/100
			4 5 6 Assembly kit	3RA19 13-2B			3/47
			The assembly kit contains:				
			4 Mechanical interlock				
			5 3 connecting clips				
			6 Wiring modules on the top and bottom for connecting the main and control conducting paths				

¹⁾ Use version with 1 NO.
²⁾ Use version with 1 NC.

* You can order this quantity or a multiple thereof.

3RA13, 3RA14 Contactor Assemblies

3RA14 Contactor Assemblies for Wye-Delta Starting

3RA14 complete units, 3 ... 75 kW

Fully wired and tested contactor assemblies · Size S0-S0-S0 · up to 18.5 kW



3RA14 2.-8XC21-1...

Rated data AC-3		Rated control supply voltage U_s ¹⁾		DT	Screw terminals	⊕	PU (UNIT, SET, M)	PS*	PG	Weight per PU approx.	
Operational current I_e at	Ratings of induction motors at 50 Hz and				A	Order No.	Price per PU			kg	
	400 V	230 V	400 V	500 V							690 V
AC operation, 50/60 Hz											
25	7.1	11	15.6	19	24 AC	C	3RA14 23-8XC21-1AC2	1	1 unit	101	1.800
					110 AC	C	3RA14 23-8XC21-1AG2	1	1 unit	101	1.800
					230 AC	C	3RA14 23-8XC21-1AL2	1	1 unit	101	1.800
32 / 40	11.4	15 / 18.5	19	19	24 AC	C	3RA14 25-8XC21-1AC2	1	1 unit	101	1.800
					110 AC	C	3RA14 25-8XC21-1AG2	1	1 unit	101	1.800
					230 AC	C	3RA14 25-8XC21-1AL2	1	1 unit	101	1.800
DC operation											
25	7.1	11	15.6	19	24 DC	▶	3RA14 23-8XC21-1BB4	1	1 unit	101	2.450
32 / 40	11.4	15 / 18.5	19	19	24 DC	▶	3RA14 25-8XC21-1BB4	1	1 unit	101	2.450

¹⁾ Coil operating range at 50 Hz: 0.8 ... 1.1 x U_s ; at 60 Hz: 0.85 ... 1.1 x U_s .

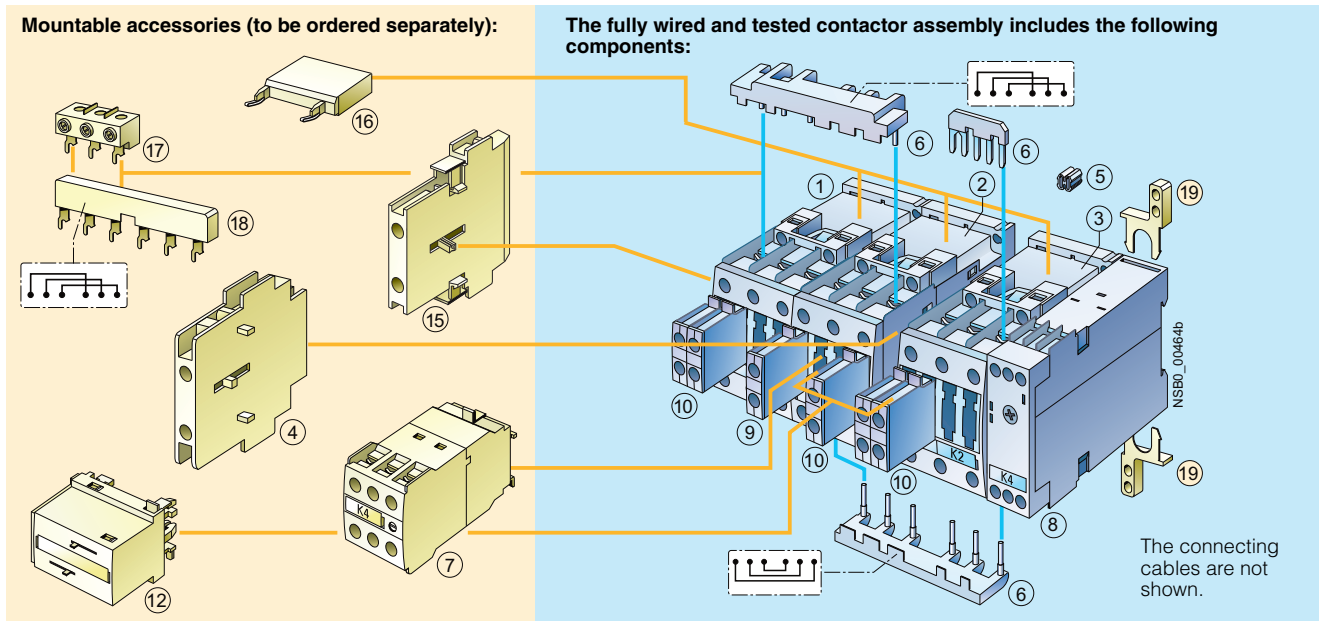

Accessories	Order No.	Page	Individual parts	Order No.			Page
				K1	K3	K2	
4 Mechanical interlock, lateral	3RA19 24-2B	3/37	1 2 3 Contactors, 11 kW	3RT10 24	3RT10 24	3RT10 24	3/16
7 Solid-state time-delay auxiliary switch block, front ¹⁾	3RT19 26-2G...	3/105	1 2 3 Contactors, 15/18.5 kW	3RT10 26	3RT10 26	3RT10 24	3/16
12 Mechanical interlock, front	3RA19 24-1A	3/37	8 Timing relay, lateral	3RP15 74-1N.30			4)
15 Auxiliary switch block, lateral	3RH19 21-1EA...	3/103	9 Auxiliary switch block with 1 unassigned NO contact	3RH19 21-1CA10			3/101
16 Surge suppressors	3RT19 26-1...	3/107	10 Auxiliary switch block for local control	3RH19 21-1CA01			3/101
17 3-phase feeder terminal ²⁾	3RV19 15-5A	3/47	- 2 units	3RH19 21-1CA10			
18 3-phase busbar ²⁾	3RT19 26-4CC20	3/47	- 3 units	3RA19 23-2B			3/47
19 Push-in lug ³⁾ for timing relay screw fixing	3RP19 03	4)	5 6 Assembly kit				

The assembly kit contains:

- 5 Connecting clips
- 6 Wiring modules on the top and bottom for connecting the main and control conducting paths

¹⁾ Generally possible. If a solid-state time-delay auxiliary switch block is mounted onto the front of K3, a standard auxiliary switch block can only be mounted onto the side.

²⁾ 17 and 18 can only be mounted with contactors with screw terminal (coil).

³⁾ Not included in the scope of supply of the preassembled contactor assemblies; can be ordered as an accessory.

⁴⁾ See "Monitoring and Control Devices: 3RP, 7PV Timing Relays --> 3RP15 Timing Relays in Industrial Enclosure, 22.5 mm".

3RA13, 3RA14 Contactor Assemblies

3RA14 Contactor Assemblies for Wye-Delta Starting

3RA14 complete units, 3 ... 75 kW

Fully wired and tested contactor assemblies · Size S2-S2-S0 · up to 30 kW

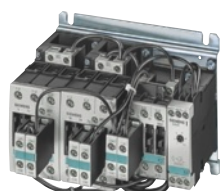

3RA14 34-8XC21-1...

1) Coil operating range at 50 Hz: 0.8 ... 1.1 x U_s; at 60 Hz: 0.85 ... 1.1 x U_s.

Rated data AC-3		Rated control supply voltage U _s ¹⁾		DT	Screw terminals	PU (UNIT, SET, M)	PS*	PG	Weight per PU approx.		
Operational current I _e up to	Ratings of induction motors at 50 Hz and				Order No.	Price per PU			kg		
	400 V	230 V	400 V	500 V						690 V	
A	kW	kW	kW	kW	V						
AC operation, 50/60 Hz											
50 / 65	19.6	22 / 30	35	34	24 AC	C	3RA14 34-8XC21-1AC2	1	1 unit	101	3.100
					110 AC	C	3RA14 34-8XC21-1AG2	1	1 unit	101	3.100
					230 AC	▶	3RA14 34-8XC21-1AL2	1	1 unit	101	3.100
DC operation											
50 / 65	19.6	22 / 30	35	34	24 DC	▶	3RA14 34-8XC21-1BB4	1	1 unit	101	4.500

Mountable accessories (to be ordered separately):

The fully wired and tested contactor assembly includes the following components:

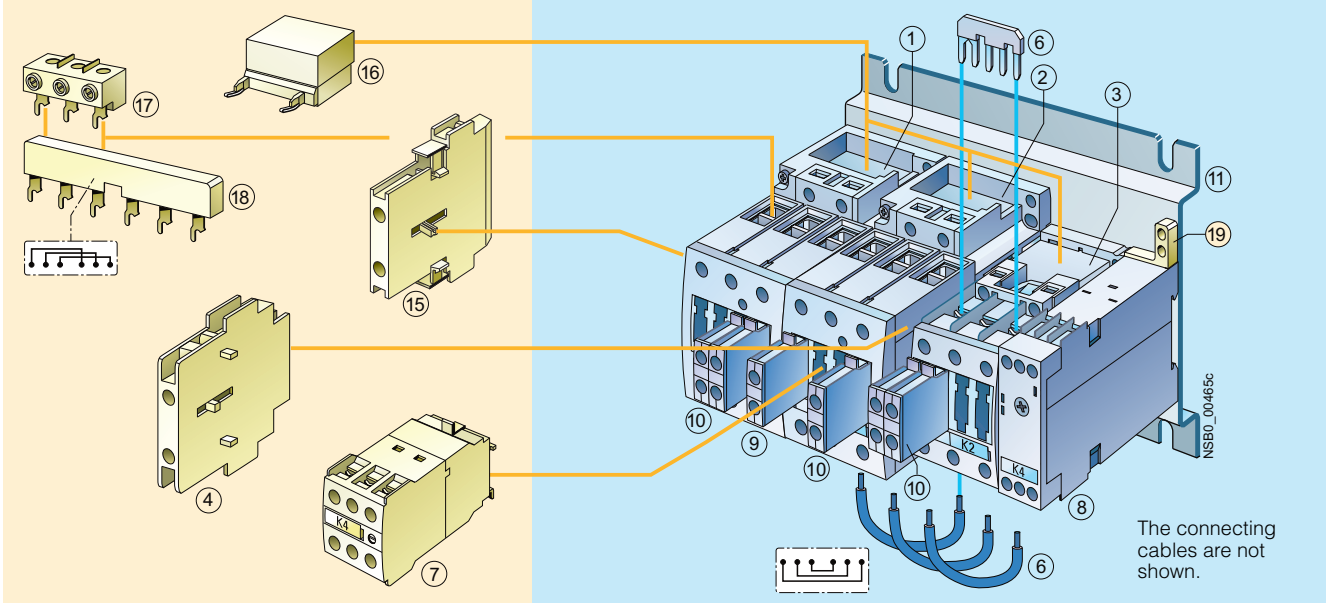

Accessories	Order No.	Page	Individual parts	Order No.			Page
				K1	K3	K2	
4 Mechanical interlock, lateral Depth compensation required K3: 1.5 mm; K2: 0 mm ¹⁾	3RA19 24-2B	3/37	1 2 3 Contactors, 22/30 kW	3RT10 34	3RT10 34	3RT10 26	3/16
7 Solid-state time-delay auxiliary switch block, front ²⁾	3RT19 26-2G...	3/105	8 Timing relay, lateral	3RP15 74-1N.30			4)
15 Auxiliary switch block, lateral	3RH19 21-1EA..	3/103	9 Auxiliary switch block with 1 unassigned NO contact	3RH19 21-1CA10			3/101
16 Surge suppressors	3RT19 26-1.... 3RT19 36-1....	3/107, 3/108	10 Auxiliary switch block for local control	3RH19 21-1CA01 3RH19 21-1CA10			3/101
17 3-phase feeder terminals	3RV19 35-5A	3/47	11 Base plate	3RA19 32-2E			3/47
18 3-phase busbars	3RV19 35-1A	3/47	6 Assembly kit	3RA19 33-2C			3/47
19 Push-in lug ³⁾ for timing relay screw fixing	3RP19 03	4)	The assembly kit contains the star jumper on the top and the wiring module on the bottom for connecting the main current paths.				

1) Use the 3RA19 32-2B base plate for this configuration.
 2) Generally possible. If a solid-state time-delay auxiliary switch block is mounted onto the front of K3, a standard auxiliary switch block can only be mounted onto the side.
 3) Not included in the scope of supply of the preassembled contactor assemblies; can be ordered as an accessory.
 4) See "Monitoring and Control Devices: 3RP, 7PV Timing Relays --> 3RP15 Timing Relays in Industrial Enclosure, 22.5 mm".

* You can order this quantity or a multiple thereof.

3RA13, 3RA14 Contactor Assemblies

3RA14 Contactor Assemblies for Wye-Delta Starting

3RA14 complete units, 3 ... 75 kW

Fully wired and tested contactor assemblies · Size S2-S2-S2 · up to 45 kW



3RA14 3.-8XC21-1...

Rated data AC-3		Rated control supply voltage U_s ¹⁾		DT	Screw terminals	PU (UNIT, SET, M)	PS*	PG	Weight per PU approx.		
Operational current I_e up to 400 V	Ratings of induction motors at 50 Hz and				Order No.	Price per PU			kg		
	230 V	400 V	500 V	690 V							
A	kW	kW	kW	V							
AC operation, 50/60 Hz											
80	25	37	51	63	24 AC	C	3RA14 35-8XC21-1AC2	1	1 unit	101	3.700
					110 AC	C	3RA14 35-8XC21-1AG2	1	1 unit	101	3.700
					230 AC	C	3RA14 35-8XC21-1AL2	1	1 unit	101	3.700
86	27	45	55	63	24 AC	C	3RA14 36-8XC21-1AC2	1	1 unit	101	3.700
					110 AC	C	3RA14 36-8XC21-1AG2	1	1 unit	101	3.700
					230 AC	C	3RA14 36-8XC21-1AL2	1	1 unit	101	3.700
DC operation											
80	25	37	51	63	24 DC	B	3RA14 35-8XC21-1BB4	1	1 unit	101	5.500
86	27	45	55	63	24 DC	B	3RA14 36-8XC21-1BB4	1	1 unit	101	5.500

¹⁾ Coil operating range at 50 Hz: 0.8 ... 1.1 x U_s ; at 60 Hz: 0.85 ... 1.1 x U_s .

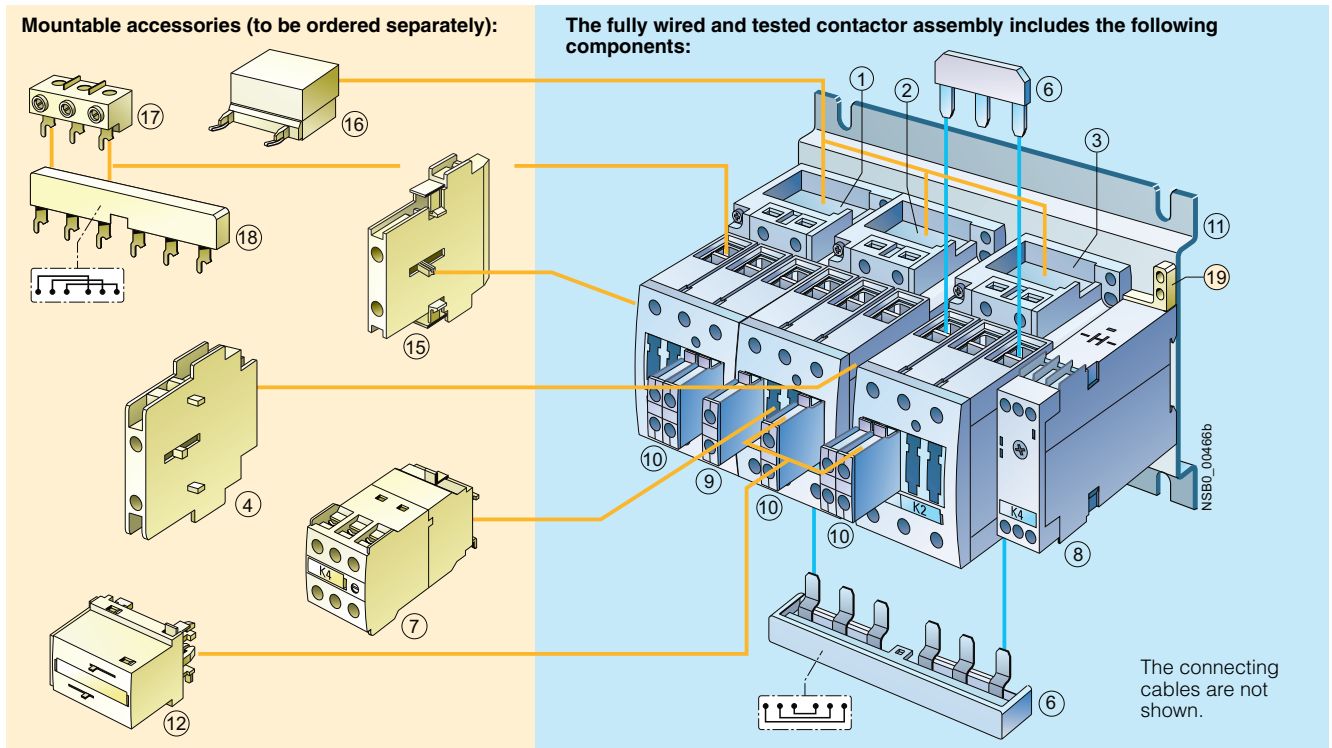

Accessories	Order No.	Page	Individual parts	Order No.			Page
				K1	K3	K2	
4 Mechanical interlock, lateral	3RA19 24-2B	3/37	1 2 3 Contactors, 37 kW	3RT10 35	3RT10 35	3RT10 34	3/17
7 Solid-state time-delay auxiliary switch block, front ¹⁾	3RT19 26-2G...	3/105	1 2 3 Contactors, 45 kW	3RT10 36	3RT10 36	3RT10 34	3/17
12 Mechanical interlock, front	3RA19 24-1A	3/37	8 Timing relay, lateral	3RP15 74-1N.30			3)
15 Auxiliary switch block, lateral	3RH19 21-1EA..	3/103	9 Auxiliary switch block with 1 unassigned NO contact	3RH19 21-1CA10			3/101
16 Surge suppressors	3RT19 26-1.... 3RT19 36-1....	3/107, 3/108	10 Auxiliary switch block for local control - 2 units - 3 units	3RH19 21-1CA01 3RH19 21-1CA10			3/101
17 3-phase feeder terminals	3RV19 35-5A	3/47	11 Base plate	3RA19 32-2F			3/47
18 3-phase busbars	3RV19 35-1A	3/47	6 Assembly kit	3RA19 33-2B			3/47
19 Push-in lug ²⁾ for timing relay screw fixing	3RP19 03	3)					

¹⁾ Generally possible. If a solid-state time-delay auxiliary switch block is mounted onto the front of K3, a standard auxiliary switch block can only be mounted onto the side.

²⁾ Not included in the scope of supply of the preassembled contactor assemblies; can be ordered as an accessory.

³⁾ See "Monitoring and Control Devices: 3RP, 7PV Timing Relays --> 3RP15 Timing Relays in Industrial Enclosure, 22.5 mm".

* You can order this quantity or a multiple thereof.

3RA13, 3RA14 Contactor Assemblies

3RA14 Contactor Assemblies for Wye-Delta Starting

3RA14 complete units, 3 ... 75 kW

Fully wired and tested contactor assemblies · Size S2-S3-S2 · up to 75 kW

Rated data AC-3		Rated control supply voltage U_s ¹⁾		DT	Screw terminals	⊕	PU (UNIT, SET, M)	PS*	PG	Weight per PU approx.	
Operational current I_e at 400 V	Ratings of induction motors at 50 Hz and				Order No.	Price per PU				kg	
	230 V	400 V	500 V	690 V							
A	kW	kW	kW	V							
AC operation, 50/60 Hz											
115	37	55	81	93	24 AC	B	3RA14 44-8XC21-1AC2	1	1 unit	101	6.000
					110 AC	B	3RA14 44-8XC21-1AG2	1	1 unit	101	6.000
					230 AC	▶	3RA14 44-8XC21-1AL2	1	1 unit	101	6.000
150	47	75	103	110	24 AC	B	3RA14 45-8XC21-1AC2	1	1 unit	101	6.000
					110 AC	B	3RA14 45-8XC21-1AG2	1	1 unit	101	6.000
					230 AC	▶	3RA14 45-8XC21-1AL2	1	1 unit	101	6.000
DC operation											
115	37	55	81	93	24 DC	B	3RA14 44-8XC21-1BB4	1	1 unit	101	8.600
150	47	75	103	110	24 DC	B	3RA14 45-8XC21-1BB4	1	1 unit	101	8.600

3RA14 4.-8XC21-1...

¹⁾ Coil operating range at 50 Hz: 0.8 ... 1.1 x U_s ; at 60 Hz: 0.85 ... 1.1 x U_s .

Mountable accessories (to be ordered separately):

The fully wired and tested contactor assembly includes the following components:

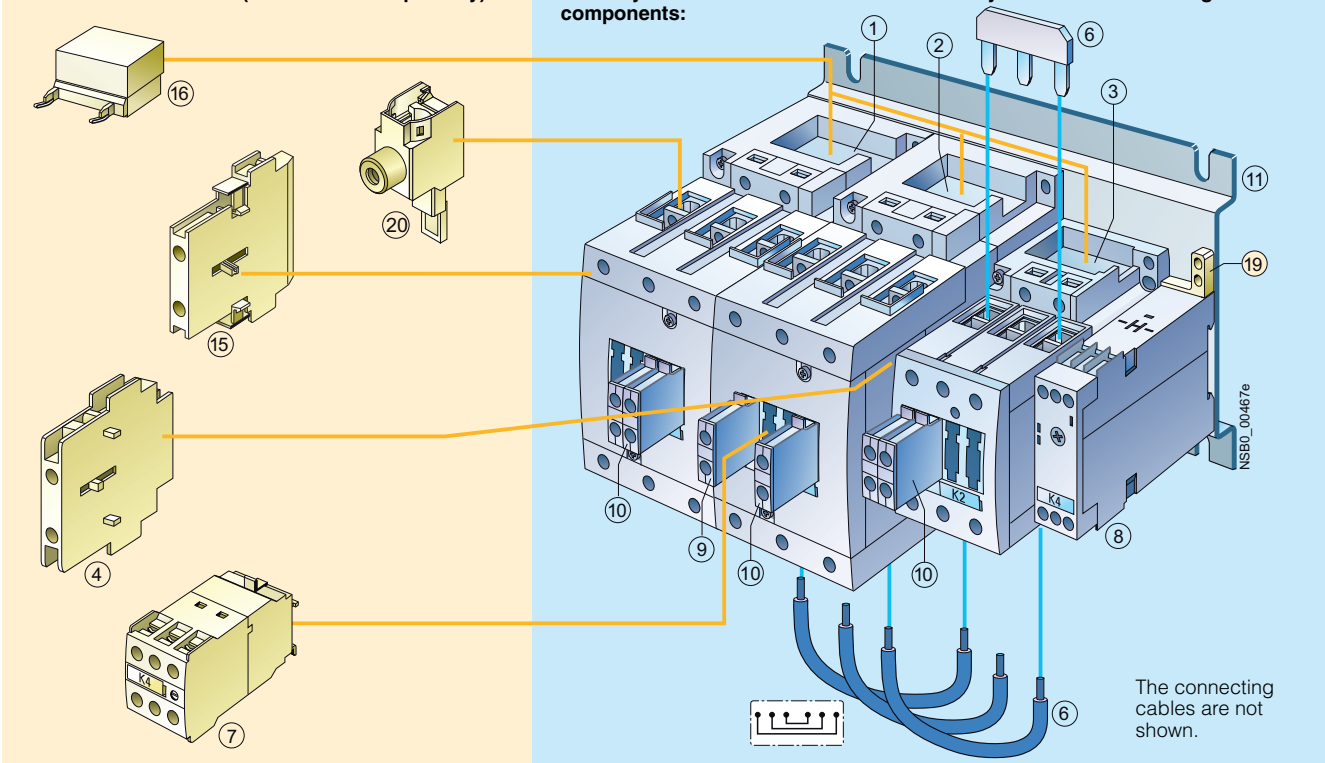

Accessories	Order No.	Page	Individual parts	Order No.			Page
				K1	K3	K2	
4 Mechanical interlock, lateral Depth compensation required K3: 0 mm; K2: 27.5 mm ¹⁾	3RA19 24-2B	3/37	1 2 3 Contactors, 55 kW 1 2 3 Contactors, 75 kW	3RT10 44	3RT10 44	3RT10 35	3/17
7 Solid-state time-delay auxiliary switch block, front ²⁾	3RT19 26-2G...	3/105	8 Timing relay, lateral 9 Auxiliary switch block with 1 unassigned NO contact	3RT10 45	3RT10 45	3RT10 36	3/17
15 Auxiliary switch block, lateral	3RH19 21-1EA..	3/103	10 Auxiliary switch block for local control	3RP15 74-1N.30			4)
16 Surge suppressors	3RT19 .6-1. ...	3/107		3RH19 21-1CA10			3/101
19 Push-in lug ³⁾ for timing relay screw fixing	3RP19 03	4)		- 2 units 3RH19 21-1CA01 - 3 units 3RH19 21-1CA10			3/101
20 1-phase feeder terminals	3RA19 43-3L	3/47	11 Base plate 6 Assembly kit	3RA19 42-2E 3RA19 43-2C			3/47 3/47

The connecting cables are not shown.

¹⁾ Use the 3RA19 42-2B base plate for this configuration.
²⁾ Generally possible. If a solid-state time-delay auxiliary switch block is mounted onto the front of K3, a standard auxiliary switch block can only be mounted onto the side.

³⁾ Not included in the scope of supply of the preassembled contactor assemblies; can be ordered as an accessory.
⁴⁾ See "Monitoring and Control Devices: 3RP, 7PV Timing Relays --> 3RP15 Timing Relays in Industrial Enclosure, 22.5 mm".

* You can order this quantity or a multiple thereof.

3RA13, 3RA14 Contactor Assemblies

3RA14 Contactor Assemblies for Wye-Delta Starting

Components for customer assembly

Selection and ordering data

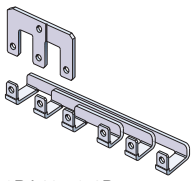
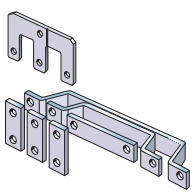
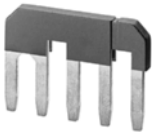
Version	Size	DT	Order No.	Price per PU	PU (UNIT, SET, M)	PS*	PG	Weight per PU approx. kg
Assembly kits								
The assembly kit contains: mechanical interlock; 3 connecting clips, star jumper, wiring modules on the top and bottom	S00-S00-S00	▶	3RA19 13-2B		1	1 unit	101	0.050
The assembly kit contains: 5 connecting clips, star jumper, wiring modules on the top and bottom	S0-S0-S0	▶	3RA19 23-2B		1	1 unit	101	0.060
 <p>The assembly kit contains: star jumper, wiring module on the bottom</p> <p>(Wiring module on the top is not included in the scope of supply. A double infeed between the line contactor and the delta contactor is recommended.)</p>	S2-S2-S0	▶	3RA19 33-2C		1	1 unit	101	0.060
	S2-S2-S2	▶	3RA19 33-2B		1	1 unit	101	0.070
	S3-S3-S2	▶	3RA19 43-2C		1	1 unit	101	0.140
	S3-S3-S3	▶	3RA19 43-2B		1	1 unit	101	0.160
	S6-S6-S6	A	3RA19 53-2B		1	1 unit	101	0.850
3RA19 53-2B	S6-S6-S6	A	3RA19 53-2N		1	1 unit	101	0.600
	S10-S10-S10	A	3RA19 63-2B		1	1 unit	101	1.800
	S12-S12-S12	B	3RA19 73-2B		1	1 unit	101	2.200
3RA19 53-2N, 3RA19 63-2B, 3RA19 73-2B								
1-phase feeder terminals								
Conductor cross-section: 95 mm ²	S3	A	3RA19 43-3L		1	1 unit	101	0.280
3-phase feeder terminals								
Feeder terminal block for the line contactor for large conductor cross-sections								
Conductor cross-section: 6 mm ²	S00	▶	3RA19 13-3K		1	1 unit	101	0.020
Conductor cross-section: 25 mm ²	S0	▶	3RV19 15-5A		1	1 unit	101	0.040
Conductor cross-section: 50 mm ²	S2	▶	3RV19 35-5A		1	1 unit	101	0.110
3-phase busbars								
Bridging phase-by-phase of all input terminals of								
the line contactor (K1) and the delta contactor (K3)	S0	D	3RT19 26-4CC20		1	1 unit	101	0.030
	S2	▶	3RV19 35-1A		1	1 unit	101	0.150
Links for paralleling, 3-pole (star jumpers)								
 <p>Without connection terminal (the links for paralleling can be reduced by one pole)</p>	S00	▶	3RT19 16-4BA31		1	1 unit	101	0.010
	S0	▶	3RT19 26-4BA31		1	1 unit	101	0.010
	S2	▶	3RT19 36-4BA31		1	1 unit	101	0.020
	S3	▶	3RT19 46-4BA31		1	1 unit	101	0.030
	S6¹⁾	▶	3RT19 56-4BA31		1	1 unit	101	0.160
S10, S12¹⁾	▶	3RT19 66-4BA31		1	1 unit	101	0.500	
3RT19 26-4BA31								
Base plates								
For customer assembly of contactor assemblies for wye-delta starting with a laterally mounted timing relay								
Side-by-side mounting	S2, S2, S0	B	3RA19 32-2E		1	1 unit	101	0.450
10 mm distance between K3 and K2	S2, S2, S2	B	3RA19 32-2F		1	1 unit	101	0.480
Side-by-side mounting	S3, S3, S2	B	3RA19 42-2E		1	1 unit	101	0.870
10 mm distance between K1, K3 and K2	S6, S6, S3	B	3RA19 52-2E		1	1 unit	101	1.800
	S6, S6, S6	B	3RA19 52-2F		1	1 unit	101	1.950
	S10, S10, S6	B	3RA19 62-2E		1	1 unit	101	3.180
	S10, S10, S10	B	3RA19 62-2F		1	1 unit	101	3.400
	S12, S12, S10	B	3RA19 72-2E		1	1 unit	101	3.600
	S12, S12, S12	B	3RA19 72-2F		1	1 unit	101	3.700
For customer assembly of contactor assemblies for wye-delta starting with a front-mounted timing relay, 10 mm distance between K1, K3 and K2	S2, S2, S0	B	3RA19 32-2B		1	1 unit	101	0.450
	S2, S2, S2	B	3RA19 32-2B		1	1 unit	101	0.450
	S3, S3, S2	B	3RA19 42-2B		1	1 unit	101	0.700

¹⁾ The 3RT19 56-4EA1 (S6) or 3RT19 66-4EA1 (S10, S12) cover can be used for touch protection.

* You can order this quantity or a multiple thereof.

3TD, 3TE Contactor Assemblies

3TD6 reversing contactor assemblies, 335 kW

Overview

The contactor assemblies are suitable for use in any climate and the contactors are mechanically interlocked. They are finger-safe according to EN 50274.

Complete units and components for customer assembly are available. For motor protection, either overload relays for stand-alone installation or thermistor motor protection tripping units must be ordered separately.

Complete units

3TD68 contactor assemblies each consist of two mechanically interlocked 3TF68 contactors. Electrical interlocking is wired. The main and control circuits are wired according to the schematics.

An internal circuit diagram, a type designation and a unit labeling plate are provided on a common cover.

Auxiliary contacts

The contactor assemblies each have 2 NO + 2 NC contacts per individual contactor. 1 NO + 1 NC contacts with momentary-contact operation and 2 NO + 1 NC contacts with continuous operation are unassigned.

Selection and ordering data

Size	Rated data AC-3				Auxiliary contacts per direction of rotation		Rated control supply voltage U_s	DT	Screw terminals 		PU (UNIT, SET, M)	PS*	PG	Weight per PU approx.
	Operational current I_e up to	Ratings of induction motors at 50 Hz and				Version			Order No.	Price per PU				
A	690 V	230 V	400 V	500 V	690 V	NO	NC	V AC						kg
Complete units														
<i>AC operation, 50/60 Hz</i>														
14	630	200	335	434	600	4	4	110 ... 132 200 ... 240	C C	3TD68 04-2CF7 3TD68 04-2CM7	1 1	1 unit 1 unit	101 101	56,000 56,000

3TD, 3TE Contactor Assemblies

3TE6 contactor assemblies for wye-delta starting, 630 kW

Overview

The contactor assemblies are suitable for use in any climate. They are finger-safe according to EN 50274.

3TE contactor assemblies are available as complete units and components for customer assembly.

The complete unit combinations are optionally supplied without a main conducting path connection between the line contactor and the delta contactor.

Motor protection

3TE68 contactor assemblies are supplied without overload protection. Overload relays or thermistor motor protection tripping units must be ordered separately.

The overload relay can be either mounted onto the line contactor or separately fitted. It must be set to 0.58 times the rated motor current.

Selection and ordering data

Size	Rated data AC-3					Rated control supply voltage U_s	DT	Screw terminals 	PU (UNIT, SET, M)	PS*	PG	Weight per PU approx.
	Operational current I_e up to	Ratings of induction motors at 50 Hz and										
	690 V	230 V	400 V	500 V	690 V							
	A	kW	kW	kW	kW	V AC						kg

Complete units, reversing time up to 10 s

AC operation, 50 Hz

Without main conducting path connection between line and delta contactor

14	1090	315	630	800	1000	110	C	3TE68 04-5CF0	1	1 unit	101	58,000
						230/220 ¹⁾	D	3TE68 04-5CP0	1	1 unit	101	58,000

For motor protection, overload relays for stand-alone installation must be ordered separately, see "Protection Equipment --> Overload Relays --> 3RB2 Solid-State Overload Relays".

¹⁾ Operating range at 220 V:
0.85 ... 1.15 x U_s ;
lower operating range limit according to IEC 60947.

3RT, 3RH, 3TB, 3TC, 3TH, 3TK Contactors for Special Applications

3RT14 Contactors for Switching Resistive Loads (AC-1)

3-pole, 140 ... 690 A

Overview

AC and DC operation (size S3)

UC operation (AC/DC) (sizes S6 to S12)

IEC 60947, EN 60947 (VDE 0660)

The contactors are suitable for use in any climate. They are finger-safe according to EN 50274.

3RT14 contactors are used for switching resistive loads (AC-1) or as contactors, for example, for variable-speed operating mechanisms that normally only have to carry the current.

The accessories for the 3RT10 contactors can also be used here.

For more detailed descriptions about the sizes S3 to S12, see [3RT10 Contactors, 3-pole, 3 to 250 kW](#).

Selection and ordering data

Size	Rated data AC-1, $T_U: 40\text{ °C}$	Rated control supply voltage U_s	DT	Screw terminals 	PU (UNIT, SET, M)	PS*	PG	Weight per PU approx.
	Operational current I_e Up to 690 V A	Ratings of AC loads (p.f. = 0.95) at 230 V 400 V 500 V 690 V kW kW kW kW V		Order No.	Price per PU			kg

For screw and snap-on mounting onto 35 mm and 75 mm standard mounting rail



3RT14 46-1A..0

AC operation

Size	I_e (A)	230 V (kW)	400 V (kW)	500 V (kW)	690 V (kW)	Control supply voltage U_s (V)	DT	Order No.	PU	PS*	PG	Weight (kg)
S3	140	53	92	115	159	24 AC, 50 Hz	B	3RT14 46-1AB00	1	1 unit	101	1.850
						110 AC, 50 Hz	B	3RT14 46-1AF00	1	1 unit	101	1.850
						230 AC, 50 Hz	▶	3RT14 46-1AP00	1	1 unit	101	1.850

DC operation · DC solenoid system

Size	I_e (A)	230 V (kW)	400 V (kW)	500 V (kW)	690 V (kW)	Control supply voltage U_s (V)	DT	Order No.	PU	PS*	PG	Weight (kg)
S3	140	53	92	115	159	24 DC	▶	3RT14 46-1BB40	1	1 unit	101	2.800
						220 DC	B	3RT14 46-1BM40	1	1 unit	101	2.800

3RT, 3RH, 3TB, 3TC, 3TH, 3TK Contactors for Special Applications

3RT14 Contactors for Switching Resistive Loads (AC-1)

3-pole, 140 ... 690 A

AC/DC operation (40 Hz to 60 Hz, DC)
 Auxiliary and control conductors: screw terminals
 Withdrawable coils
 Integrated coil circuit (Varistor)
 Main conductors: busbar connections

Size	Rated data AC-1, T_U : 40 °C				Auxiliary contacts		Rated control supply voltage U_s	DT	Screw terminals 	PU (UNIT, SET, M)	PS*	PG	Weight per PU approx.
	Operational current I_e Up to 690 V	Ratings of AC loads (p.f. = 0.95) at				Version							
A	230 V	400 V	500 V	690 V	NO	NC	V	Order No.	Price per PU				

Conventional operating mechanisms



3RT14 6.

S6	275	105	180	225	310	2	2	110 ... 127 ▶ 220 ... 240 ▶	3RT14 56-6AF36 3RT14 56-6AP36	1 1	1 unit 1 unit	101 101	3.360 3.360
S10	400	151	263	329	454	2	2	110 ... 127 ▶ 220 ... 240 ▶	3RT14 66-6AF36 3RT14 66-6AP36	1 1	1 unit 1 unit	101 101	6.600 6.600
S12	690	261	454	568	783	2	2	110 ... 127 A 220 ... 240 ▶	3RT14 76-6AF36 3RT14 76-6AP36	1 1	1 unit 1 unit	101 101	10.500 10.500

Solid-state operating mechanisms · for 24 V DC PLC output

S6	275	105	180	225	310	2	2	96 ... 127 B 200 ... 277 A	3RT14 56-6NF36 3RT14 56-6NP36	1 1	1 unit 1 unit	101 101	3.400 3.400
S10	400	151	263	329	454	2	2	96 ... 127 B 200 ... 277 A	3RT14 66-6NF36 3RT14 66-6NP36	1 1	1 unit 1 unit	101 101	6.600 6.600
S12	690	261	454	568	783	2	2	96 ... 127 B 200 ... 277 A	3RT14 76-6NF36 3RT14 76-6NP36	1 1	1 unit 1 unit	101 101	10.500 10.500

Solid-state operating mechanisms · for 24 V DC PLC output/PLC relay output, with remaining lifetime indicator (RLT)

S6	275	105	180	225	310	1	1	96 ... 127 B 200 ... 277 B	3RT14 56-6PF35 3RT14 56-6PP35	1 1	1 unit 1 unit	101 101	4.200 4.200
S10	400	151	263	329	454	1	1	200 ... 277 B	3RT14 66-6PP35	1	1 unit	101	5.700
S12	690	261	454	568	783	1	1	200 ... 277 B	3RT14 76-6PP35	1	1 unit	101	10.500

Solid-state operating mechanisms · with AS-Interface and remaining lifetime indicator (RLT)

S6	275	105	180	225	310	1	1	96 ... 127 B 200 ... 277 B	3RT14 56-6QF35 3RT14 56-6QP35	1 1	1 unit 1 unit	101 101	3.100 3.100
S10	400	151	263	329	454	1	1	200 ... 277 B	3RT14 66-6QP35	1	1 unit	101	5.700
S12	690	261	454	568	783	1	1	200 ... 277 B	3RT14 76-6QP35	1	1 unit	101	10.500

For other voltages see page 3/26.
 For accessories, see page 3/100.
 For spare parts, see page 3/114.

3RT, 3RH, 3TB, 3TC, 3TH, 3TK Contactors for Special Applications

3RT13 Contactors for Switching Resistive Loads (AC-1)

4-pole, 4 NO, 18 ... 140 A

Overview

AC and DC operation

EN 60947-4-1 (VDE 0660, Part 102).

The contactors are suitable for use in any climate. They are finger-safe according to EN 50274.

The accessories for the 3-pole SIRIUS contactors can also be used for the 4-pole versions.

The contactors are also suitable for switching mixed loads in distribution systems (e. g. for supplying heaters, lamps, motors, PC power supply units) with p.f. > 0.8 according to IEC 60947-4-1 test conditions for utilization category AC-1.

Selection and ordering data

AC operation, 4 NO contacts

PU (UNIT, SET, M)= 1
PS* = 1 unit
PG = 101



3RT13 1.-1A.00



3RT13 2.-1A.00

Rated data AC-1, T_{ij} : 40/60 °C	Rated control supply voltage U_s	DT	Screw terminals	Weight per PU approx.	DT	Cage Clamp terminals	Weight per PU approx.
Operational current I_e	Ratings of AC loads (p.f. = 0.95) at 50 Hz and 400 V		Order No.	Price per PU		Order No.	Price per PU
A	kW	V AC					kg

For screw and snap-on mounting onto 35 mm standard mounting rail

Size S00¹⁾

18 / 16	12 / 11	24, 50/60 Hz ▶	3RT13 16-1AB00	0.200 B	3RT13 16-2AB00	0.200
		110, 50/60 Hz ▶	3RT13 16-1AF00	0.200 B	3RT13 16-2AF00	0.200
		230, 50/60 Hz ▶	3RT13 16-1AP00	0.200 B	3RT13 16-2AP00	0.200
22 / 20	14.5 / 13	24, 50/60 Hz ▶	3RT13 17-1AB00	0.200 B	3RT13 17-2AB00	0.200
		110, 50/60 Hz ▶	3RT13 17-1AF00	0.200 B	3RT13 17-2AF00	0.200
		230, 50/60 Hz ▶	3RT13 17-1AP00	0.200 B	3RT13 17-2AP00	0.200

Size S0

35 / 30 ²⁾	22 / 20	24, 50 Hz ▶	3RT13 25-1AB00	0.400	--	
		110, 50 Hz ▶	3RT13 25-1AF00	0.400	--	
		230, 50 Hz ▶	3RT13 25-1AP00	0.400	--	
40 / 35 ²⁾	26 / 23	24, 50 Hz ▶	3RT13 26-1AB00	0.400	--	
		110, 50 Hz ▶	3RT13 26-1AF00	0.400	--	
		230, 50 Hz ▶	3RT13 26-1AP00	0.400	--	

Size S2

60 / 55	39 / 36	24, 50 Hz ▶	3RT13 36-1AB00	0.990	--	
		110, 50 Hz ▶	3RT13 36-1AF00	0.990	--	
		230, 50 Hz ▶	3RT13 36-1AP00	0.990	--	

Size S3

110 / 100	72 / 66	24, 50 Hz ▶	3RT13 44-1AB00	2.200	--	
		110, 50 Hz ▶	3RT13 44-1AF00	2.200	--	
		230, 50 Hz ▶	3RT13 44-1AP00	2.200	--	
140 / 120	92 / 79	24, 50 Hz ▶	3RT13 46-1AB00	2.200	--	
		110, 50 Hz ▶	3RT13 46-1AF00	2.200	--	
		230, 50 Hz ▶	3RT13 46-1AP00	2.200	--	

Size S00:

Snap-on auxiliary switch blocks according to EN 50005.

Sizes S0 to S3:

Snap-on auxiliary switch blocks according to EN 50012 and EN 50005 (for S0 max. 2 auxiliary contacts, please note information in Technical Information LV 1 T).

For other voltages see page 3/26.

For accessories, see page 3/100.

For spare parts, see page 3/114.

¹⁾ For size S00: Coil operating range at 50 Hz: 0.8 ... 1.1 x U_s , at 60 Hz: 0.85 ... 1.1 x U_s .

²⁾ Minimum conductor cross-section 10 mm².

3RT, 3RH, 3TB, 3TC, 3TH, 3TK Contactors for Special Applications

3RT13 Contactors for Switching Resistive Loads (AC-1)

4-pole, 4 NO, 18 ... 140 A

DC operation - DC solenoid system, 4 NO contacts

PU (UNIT, SET, M) = 1
 PS* = 1 unit
 PG = 101



3RT13 1.-2B...0



3RT13 36-1...0



3RT13 4.-1...0

Rated data AC-1, T_U : 40/60 °C		Rated control supply voltage U_s	DT	Screw terminals		Weight per PU approx.	DT	Cage Clamp terminals		Weight per PU approx.
Operational current I_e	Ratings of AC loads (p.f. = 0.95) at 50 Hz and 400 V kW			Order No.	Price per PU			Order No.	Price per PU	
A		V DC			kg				kg	

For screw and snap-on mounting onto 35 mm standard mounting rail

Size S00

18 / 16	12 / 11	24	▶	3RT13 16-1BB40	0.250	▶	3RT13 16-2BB40	0.250
		220	B	3RT13 16-1BM40	0.250	B	3RT13 16-2BM40	0.250
22 / 20	14.5 / 13	24	▶	3RT13 17-1BB40	0.250	A	3RT13 17-2BB40	0.250
		220	B	3RT13 17-1BM40	0.250	B	3RT13 17-2BM40	0.250

Size S0

35 / 30 ¹⁾	22 / 20	24	▶	3RT13 25-1BB40	0.630	--		
		220	B	3RT13 25-1BM40	0.630	--		
40 / 35 ¹⁾	26 / 23	24	▶	3RT13 26-1BB40	0.630	--		
		220	B	3RT13 26-1BM40	0.630	--		

Size S2

60 / 55	39 / 36	24	▶	3RT13 36-1BB40	1.600	--		
		220	B	3RT13 36-1BM40	1.600	--		

Size S3

110 / 100	72 / 66	24	B	3RT13 44-1BB40	3.200	--		
		220	B	3RT13 44-1BM40	3.200	--		
140 / 120	92 / 79	24	B	3RT13 46-1BB40	3.200	--		
		220	B	3RT13 46-1BM40	3.200	--		

Size S00:

Snap-on auxiliary switch blocks according to EN 50005.

Sizes S0 to S3:

Snap-on auxiliary switch blocks according to EN 50012 and EN 50005
(for S0 max. 2 auxiliary contacts, please note information in Technical Information LV 1 T).

For other voltages see page 3/26.

For accessories, see page 3/100.

For spare parts, see page 3/114.

¹⁾ Minimum conductor cross-section 10 mm².

3RT, 3RH, 3TB, 3TC, 3TH, 3TK Contactors for Special Applications

3TK1 Contactors for Switching Resistive Loads (AC-1)

4-pole, 4 NO, 200 ... 1000 A

Overview

EN 60947-4-1 (VDE 0660 Part 102)

The contactors also comply with the requirements of NFC 63-110 and NFC 20-040.

The contactors are suitable for use in any climate. They are finger-safe according to EN 50274. Terminal covers may have to be fitted onto the connecting bars, depending on the configuration with other devices.

The contactors are also suitable for switching mixed loads in distribution systems (e. g. for supplying heaters, lamps, motors, PC power supply units) with p.f. > 0.8 according to IEC 60947-4-1 test conditions for utilization category AC-1.

Solenoid coils for 3TK10 to 3TK13 contactors: as withdrawable coils.

Surge suppression

Control circuit

Solenoid coils for 3TK1 contactors: can be retrofitted with RC elements.

Selection and ordering data

Screw terminals

Screw fixing



3TK13

Rated data AC-1					Auxiliary contacts		Rated control supply voltage U_s	DT	Screw terminals	⊕	PU (UNIT, SET, M)	PS*	PG	Weight per PU approx.
Operational current I_e up to 690 V (at 40 °C)	Rating of AC loads (p.f. = 0.95) at				Version		V AC		Order No.	Price per PU				kg
	230 V	400 V	690 V	1000 V	NO	NC								
A	kW	kW	kW	kW										
AC operation														
200	75	130	225	205	2	2	220 ... 230, 50 Hz	B	3TK10 42-0AP0		1	1 unit	101	4.400
							230 ... 240, 50 Hz	D	3TK10 42-0AU0		1	1 unit	101	4.400
							110/120, 50/60 Hz	D	3TK10 42-0AF0		1	1 unit	101	4.400
							24, 50 Hz	D	3TK10 42-0AB0		1	1 unit	101	4.400
250	90	165	280	200	2	2	220 ... 230, 50 Hz	B	3TK11 42-0AP0		1	1 unit	101	4.700
							230 ... 240, 50 Hz	D	3TK11 42-0AU0		1	1 unit	101	4.700
							110/120, 50/60 Hz	D	3TK11 42-0AF0		1	1 unit	101	4.700
							24, 50 Hz	D	3TK11 42-0AB0		1	1 unit	101	4.700
300	110	195	340	325	2	2	220 ... 230, 50 Hz	B	3TK12 42-0AP0		1	1 unit	101	7.200
							230 ... 240, 50 Hz	D	3TK12 42-0AU0		1	1 unit	101	7.200
							110/120, 50/60 Hz	D	3TK12 42-0AF0		1	1 unit	101	7.200
							24, 50 Hz	D	3TK12 42-0AB0		1	1 unit	101	7.200
350	130	230	395	370	2	2	220 ... 230, 50 Hz	B	3TK13 42-0AP0		1	1 unit	101	7.200
							230 ... 240, 50 Hz	D	3TK13 42-0AU0		1	1 unit	101	7.200
							110/120, 50/60 Hz	D	3TK13 42-0AF0		1	1 unit	101	7.200
							24, 50 Hz	D	3TK13 42-0AB0		1	1 unit	101	7.200
550	205	360	620	510	2	2	220 ... 230, 50 Hz ¹⁾	B	3TK14 42-0AP0		1	1 unit	101	19.000
							230 ... 240, 50 Hz	D	3TK14 42-0AU0		1	1 unit	101	19.000
							110/120, 50/60 Hz	D	3TK14 42-0AF0		1	1 unit	101	19.000
800	300	525	905	575	2	2	220 ... 230, 50 Hz ¹⁾	B	3TK15 42-0AP0		1	1 unit	101	19.000
							230 ... 240, 50 Hz	D	3TK15 42-0AU0		1	1 unit	101	19.000
							110/120, 50/60 Hz	D	3TK15 42-0AF0		1	1 unit	101	19.000
1000	375	655	1135	--	2	2	220 ... 230, 50 Hz ¹⁾	B	3TK17 42-0AP0		1	1 unit	101	20.100
							230 ... 240, 50 Hz	D	3TK17 42-0AU0		1	1 unit	101	20.100
							110/120 50/60 Hz	D	3TK17 42-0AF0		1	1 unit	101	20.100

For accessories, see page 3/119 onwards.

For spare parts, see page 3/127 onwards.

¹⁾ At 60 Hz: 240 V.

3RT, 3RH, 3TB, 3TC, 3TH, 3TK Contactors for Special Applications

3TK20 Contactors

4-pole, 4 kW

Overview

AC and DC operation

IEC 60947 (VDE 0660).

The contactors are suitable for use in any climate.

The contactors with screw terminals are finger-safe according to EN 50274.

The contactors are available in versions with screw terminals, 6.3 mm plug-in terminals and solder pin connections for soldering in printed circuit boards.

Application

The main area of application for the 3TK2 contactors with flat connectors is in household equipment. These contactors are also suitable for simple electric controllers. No auxiliary switch blocks can be retrofitted.

Selection and ordering data

Size 00

AC-1: operational current $I_e = 16 A$ (at 55 °C)

Rated data		Utilization categories AC-2 and AC-3				Main contacts	DT	Order No.	Price per PU	PU (UNIT, SET, M)	PS*	PG	Weight per PU approx.
Operational current I_e at 400/380 V	Ratings of induction motors at 50 Hz and				Version							kg	
	230/220 V	400/380 V	500 V	690/660 V	NO	NC							
A	kW	kW	kW	kW									

Contactors with screw terminals for screw and snap-on mounting onto 35 mm standard mounting rail



3TK20...-0...

AC operation

9	2.4	4	4	4	4	--	C	3TK20 40-0AP0	1	1 unit	101	0.190
							C <td>3TK20 31-0AP0</td> <td>1 <td>1 unit <td>101 <td>0.190</td> </td></td></td>	3TK20 31-0AP0	1 <td>1 unit <td>101 <td>0.190</td> </td></td>	1 unit <td>101 <td>0.190</td> </td>	101 <td>0.190</td>	0.190
							C <td>3TK20 22-0AP0</td> <td>1 <td>1 unit <td>101 <td>0.190</td> </td></td></td>	3TK20 22-0AP0	1 <td>1 unit <td>101 <td>0.190</td> </td></td>	1 unit <td>101 <td>0.190</td> </td>	101 <td>0.190</td>	0.190

DC operation · DC solenoid system

9	2.4	4	4	4	4	--	C	3TK20 40-0BB4	1	1 unit	101	0.210
							C <td>3TK20 31-0BB4</td> <td>1 <td>1 unit <td>101 <td>0.210</td> </td></td></td>	3TK20 31-0BB4	1 <td>1 unit <td>101 <td>0.210</td> </td></td>	1 unit <td>101 <td>0.210</td> </td>	101 <td>0.210</td>	0.210
							C <td>3TK20 22-0BB4</td> <td>1 <td>1 unit <td>101 <td>0.210</td> </td></td></td>	3TK20 22-0BB4	1 <td>1 unit <td>101 <td>0.210</td> </td></td>	1 unit <td>101 <td>0.210</td> </td>	101 <td>0.210</td>	0.210

Contactors with screw terminals 6.3 mm x 0.8 mm for screw and snap-on mounting onto 35 mm standard mounting rail



3TK20...-3...

AC operation

9	2.4	4	4	--	4	--	C	3TK20 40-3AP0	1	1 unit	101	0.170
							C <td>3TK20 31-3AP0</td> <td>1 <td>1 unit <td>101 <td>0.170</td> </td></td></td>	3TK20 31-3AP0	1 <td>1 unit <td>101 <td>0.170</td> </td></td>	1 unit <td>101 <td>0.170</td> </td>	101 <td>0.170</td>	0.170
							C <td>3TK20 22-3AP0</td> <td>1 <td>1 unit <td>101 <td>0.170</td> </td></td></td>	3TK20 22-3AP0	1 <td>1 unit <td>101 <td>0.170</td> </td></td>	1 unit <td>101 <td>0.170</td> </td>	101 <td>0.170</td>	0.170

DC operation · DC solenoid system

9	2.4	4	4	--	4	--	C	3TK20 40-3BB4	1	1 unit	101	0.190
							C <td>3TK20 31-3BB4</td> <td>1 <td>1 unit <td>101 <td>0.190</td> </td></td></td>	3TK20 31-3BB4	1 <td>1 unit <td>101 <td>0.190</td> </td></td>	1 unit <td>101 <td>0.190</td> </td>	101 <td>0.190</td>	0.190
							C <td>3TK20 22-3BB4</td> <td>1 <td>1 unit <td>101 <td>0.190</td> </td></td></td>	3TK20 22-3BB4	1 <td>1 unit <td>101 <td>0.190</td> </td></td>	1 unit <td>101 <td>0.190</td> </td>	101 <td>0.190</td>	0.190

Contactors with flat connectors 6.3 mm x 0.8 mm for screw fixing (diagonal)



3TK20...-7...

AC operation

9	2.4	4	4	--	4	--	C	3TK20 40-7AP0	1	1 unit	101	0.170
							C <td>3TK20 31-7AP0</td> <td>1 <td>1 unit <td>101 <td>0.170</td> </td></td></td>	3TK20 31-7AP0	1 <td>1 unit <td>101 <td>0.170</td> </td></td>	1 unit <td>101 <td>0.170</td> </td>	101 <td>0.170</td>	0.170
							C <td>3TK20 22-7AP0</td> <td>1 <td>1 unit <td>101 <td>0.170</td> </td></td></td>	3TK20 22-7AP0	1 <td>1 unit <td>101 <td>0.170</td> </td></td>	1 unit <td>101 <td>0.170</td> </td>	101 <td>0.170</td>	0.170

DC operation · DC solenoid system

9	2.4	4	4	--	4	--	C	3TK20 40-7BB4	1	1 unit	101	0.190
							C <td>3TK20 31-7BB4</td> <td>1 <td>1 unit <td>101 <td>0.190</td> </td></td></td>	3TK20 31-7BB4	1 <td>1 unit <td>101 <td>0.190</td> </td></td>	1 unit <td>101 <td>0.190</td> </td>	101 <td>0.190</td>	0.190
							C <td>3TK20 22-7BB4</td> <td>1 <td>1 unit <td>101 <td>0.190</td> </td></td></td>	3TK20 22-7BB4	1 <td>1 unit <td>101 <td>0.190</td> </td></td>	1 unit <td>101 <td>0.190</td> </td>	101 <td>0.190</td>	0.190

Contactors with solder pin connections for printed circuit boards¹⁾ for screw fixing (diagonal)



3TK20...-6...

AC operation

9	2.4	4	4	--	4	--	C	3TK20 40-6AP0	1	1 unit	101	0.170
							C <td>3TK20 31-6AP0</td> <td>1 <td>1 unit <td>101 <td>0.170</td> </td></td></td>	3TK20 31-6AP0	1 <td>1 unit <td>101 <td>0.170</td> </td></td>	1 unit <td>101 <td>0.170</td> </td>	101 <td>0.170</td>	0.170
							C <td>3TK20 22-6AP0</td> <td>1 <td>1 unit <td>101 <td>0.170</td> </td></td></td>	3TK20 22-6AP0	1 <td>1 unit <td>101 <td>0.170</td> </td></td>	1 unit <td>101 <td>0.170</td> </td>	101 <td>0.170</td>	0.170

DC operation · DC solenoid system

9	2.4	4	4	--	4	--	C	3TK20 40-6BB4	1	1 unit	101	0.190
							C <td>3TK20 31-6BB4</td> <td>1 <td>1 unit <td>101 <td>0.190</td> </td></td></td>	3TK20 31-6BB4	1 <td>1 unit <td>101 <td>0.190</td> </td></td>	1 unit <td>101 <td>0.190</td> </td>	101 <td>0.190</td>	0.190
							C <td>3TK20 22-6BB4</td> <td>1 <td>1 unit <td>101 <td>0.190</td> </td></td></td>	3TK20 22-6BB4	1 <td>1 unit <td>101 <td>0.190</td> </td></td>	1 unit <td>101 <td>0.190</td> </td>	101 <td>0.190</td>	0.190

For accessories, see page 3/122.

¹⁾ Operating range at AC-1 220 V: 0.85 to 1.15 x U_s ; lower operating range limit according to IEC 60947.

* You can order this quantity or a multiple thereof.

3RT, 3RH, 3TB, 3TC, 3TH, 3TK Contactors for Special Applications

3TK20 Contactors

4-pole, 4 kW

*Rated control supply voltages
(the 10th and 11th position of the order number must be
changed)*

Contactor type		3TK20
Rated control supply voltage U_s		
AC operation		
Solenoid coils for AC 50 and 60 Hz		
50 Hz	60 Hz	
230/220 V AC	276 V AC	P0 ¹⁾
DC operation		
24 V DC		B4

¹⁾ Operating range at 220 V:
0.85 to 1.15 x U_s ; lower operating range limit according to IEC 60947.

[Please inquire about other voltages.](#)

3RT, 3RH, 3TB, 3TC, 3TH, 3TK Contactors for Special Applications

3RT15 Contactors

4-pole, 2 NO + 2 NC, 4 ... 18.5 kW

Overview

AC and DC operation

EN 60947-4-1 (VDE 0660, Part 102).

The contactors are suitable for use in any climate. They are finger-safe according to EN 50274.

The accessories for the 3-pole SIRIUS contactors can also be used for the 4-pole versions.

Selection and ordering data

AC and DC operation, 2 NO contacts + 2 NC contacts¹⁾

PU (UNIT, SET, M) = 1
 PS* = 1 unit
 PG = 101



3RT15 1.-1....



3RT15 1.-2....



3RT15 26-1....

Rated data		Rated control supply voltage U_s		DT	Screw terminals		Weight per PU approx.	DT	Cage Clamp terminals		Weight per PU approx.
AC-2/AC-3, T_U : Up to 60 °C		AC-1, T_U : 40/60 °C			⊕				⊕		
Operational current I_e	Rating of induction motors at 50 Hz and at 400 V	Operational current I_e		Order No.	Price per PU		kg	Order No.	Price per PU		kg
A	kW	A	V								

For screw and snap-on mounting onto 35 mm standard mounting rail

AC operation

Size S00²⁾

9	4	18 / 16	24, 50/60 Hz	B	3RT15 16-1AB00	0.200	B	3RT15 16-2AB00	0.200
			110, 50/60 Hz	B	3RT15 16-1AF00	0.200	B	3RT15 16-2AF00	0.200
			230, 50/60 Hz	▶	3RT15 16-1AP00	0.200	B	3RT15 16-2AP00	0.200
12	5.5	22 / 20	24, 50/60 Hz	A	3RT15 17-1AB00	0.200	B	3RT15 17-2AB00	0.200
			110, 50/60 Hz	▶	3RT15 17-1AF00	0.200	B	3RT15 17-2AF00	0.200
			230, 50/60 Hz	▶	3RT15 17-1AP00	0.200	▶	3RT15 17-2AP00	0.200

Size S0

25	11	40 / 35 ³⁾	24, 50 Hz	B	3RT15 26-1AB00	0.400	--	--	--
			110, 50 Hz	B	3RT15 26-1AF00	0.400	--	--	--
			230, 50 Hz	▶	3RT15 26-1AP00	0.400	--	--	--

Size S2

40	18.5	55 / 50	24, 50 Hz	B	3RT15 35-1AB00	1.000	--	--	--
			110, 50 Hz	B	3RT15 35-1AF00	1.000	--	--	--
			230, 50 Hz	▶	3RT15 35-1AP00	1.000	--	--	--

DC operation · DC solenoid system

Size S00

9	4	18 / 16	24 DC	▶	3RT15 16-1BB40	0.260	▶	3RT15 16-2BB40	0.260
			220 DC	B	3RT15 16-1BM40	0.260	B	3RT15 16-2BM40	0.260
12	5.5	22 / 20	24 DC	▶	3RT15 17-1BB40	0.260	B	3RT15 17-2BB40	0.260
			220 DC	B	3RT15 17-1BM40	0.260	B	3RT15 17-2BM40	0.260

Size S0

20	11	40 / 35 ³⁾	24 DC	▶	3RT15 26-1BB40	0.630	--	--	--
			220 DC	B	3RT15 26-1BM40	0.630	--	--	--

Size S2

40	18.5	55 / 50	24 DC	▶	3RT15 35-1BB40	1.590	--	--	--
			220 DC	B	3RT15 35-1BM40	1.590	--	--	--

Size S00: Snap-on auxiliary switch blocks according to EN 50005.

Size S0 to S3: Snap-on auxiliary switch blocks according to EN 50012 and EN 50005

(for S0 max. 2 auxiliary contacts, please note information in the Technical Information LV 1 T).

For other voltages see page 3/26.

For accessories, see page 3/100.

For spare parts, see page 3/114.

¹⁾ Single device for pole reversal; not suitable for reversing duty.²⁾ For size S00: Coil operating range at 50 Hz: 0.8 ... 1.1 x U_s
at 60 Hz: 0.85 ... 1.1 x U_s .³⁾ Required conductor cross-section: 10 mm².

3RT, 3RH, 3TB, 3TC, 3TH, 3TK Contactors for Special Applications

3RT16 Capacitor Contactors

12.5 ... 50 kvar

Overview

AC operation

IEC 60947, EN 60947 (VDE 0660).

The contactors are suitable for use in any climate. They are finger-safe according to EN 50274.

The 3RT16 capacitor contactors are special versions of the size S00 to S3 SIRIUS contactors. The capacitors are precharged by means of the mounted leading NO contacts and resistors; only then do the main contacts close.

This prevents disturbances in the network and welding of the contactors.

Only discharged capacitors are permitted to be switched on with capacitor contactors.

The auxiliary switch block which is snapped onto the capacitor contactor contains the three leading NO contacts and in the case of S00 one standard NC contact and in the case of S0 and S3 one standard NO contact, which is unassigned. Size S00 also contains another unassigned NO contact in the basic unit.

In addition, a 2-pole auxiliary switch block can be mounted laterally on the 3RT16 47 capacitor contactors (2 NO, 2 NC or 1 NO + 1 NC versions); type 3RH19 21-1EA... The fitting of auxiliary switches for 3RT16 17 and 3RT16 27 is not expandable.

For the capacitor switching capacity of the basic 3RT10 contactor version, see [Technical Information LV 1 T](#) -> "Technical specifications".

Selection and ordering data

AC operation Screw terminals



3RT16 17-1A.03



3RT16 27-1A.01



3RT16 47-1A.01

Utilization category AC-6b				Auxiliary contacts, unassigned		Rated control supply voltage $U_s^{(2)}$		DT	Screw terminals	PU (UNIT, SET, M)	PS*	PG	Weight per PU approx.
Switching of AC capacitors for an ambient temperature of 60 °C ¹⁾				Version					⊕				
Capacitor rating at operational voltage 50/60 Hz									Order No.	Price per PU			
at 230 V	at 400 V	at 525 V	at 690 V	NO	NC	V AC	Hz						kg
kvar	kvar	kvar	kvar										

For screw and snap-on mounting onto 35 mm standard mounting rail

Size S00

3 ... 7.5	5 ... 12.5	7.5 ... 15	10 ... 21	1	1	24	50 / 60	B	3RT16 17-1AB03	1	1 unit	101	0.280
						110		B	3RT16 17-1AF03	1	1 unit	101	0.280
						230		▶	3RT16 17-1AP03	1	1 unit	101	0.280

Size S0³⁾

3.5 ... 15	6 ... 25	7.8 ... 30	10 ... 42	1	--	24	50	B	3RT16 27-1AB01	1	1 unit	101	0.440
						110		B	3RT16 27-1AF01	1	1 unit	101	0.440
						230		▶	3RT16 27-1AP01	1	1 unit	101	0.440

Size S3

3.5 ... 30	5 ... 50	7.5 ... 60	10 ... 84	1	--	24	50	B	3RT16 47-1AB01	1	1 unit	101	2.040
						110		B	3RT16 47-1AF01	1	1 unit	101	2.040
						230		▶	3RT16 47-1AP01	1	1 unit	101	2.040

For other voltages see page 3/26.

For accessories, see page 3/103.

¹⁾ For size S3: 55 °C.

²⁾ Operating range: 0.85 ... 1.1 × U_s .

³⁾ For conductor cross-sections > 6 mm² use 3RV19 25-5AB terminals (2 units).

3RT, 3RH, 3TB, 3TC, 3TH, 3TK Contactors for Special Applications

Contactors with Extended Operating Range 0.7 ... 1.25 x U_s , for Railway Applications

3RH11 contactor relays

Overview

DC operation

IEC 60947-4-1, EN 60947-4-1 (VDE 0660, Part 102), for requirements according to IEC 60077-1 and IEC 60077-2.

The contactor relays are finger-safe according to EN 50274. The size S00 contactor relays have Cage Clamp connections for all terminals.

Ambient temperature

The permissible ambient temperature for operation of the contactor relays (across the full solenoid coil operating range) is -40 °C to +70 °C.

Uninterrupted duty at temperatures > +60 °C reduces the mechanical endurance, the current-carrying capacity of the conducting paths and the switching frequency.

Application

For operation in installations which are subject both to considerable variations in the control voltage and to high ambient temperatures, e. g. railway applications under extreme climatic conditions, rolling mills, etc.

Control and auxiliary circuits

The solenoid coils of the contactor relays have an extended operating range from 0.7 to 1.25 x U_s and are fitted as standard with varistors to provide protection against overvoltage. The opening delay is consequently 2 to 5 ms longer than for standard contactors.

3RH11 22-2K.40-0LA0

The DC solenoid systems of the contactor relays are modified (to hold-in coil) by means of a series resistor.

The size S00 contactor relays are supplied prewired with a plug-on module containing the series resistor. The varistor is integrated. A 4-pole auxiliary switch block (according to EN 50005) can be fitted additionally.

Mounting

At ambient temperatures up to 70 °C, the size S00 contactor relays are allowed to be mounted side by side.

3RH11 22-2K.40

These contactor relays have an extended operating range from 0.7 to 1.25 x U_s ; the coils are fitted with varistors as standard. An additional series resistor is not required. Please note:

- Size S00: It is not possible to mount an auxiliary switch block.

At ambient temperatures > 60 °C ≤ 70 °C, a clearance of 10 mm is required when they are mounted side by side.

Selection and ordering data

DC operation - DC solenoid system

Cage Clamp terminals

For screw and snap-on mounting onto standard mounting rail

Solenoid coil fitted with varistor



3RH11 22-2K.40



3RH11 22-2K.40-0LA0

Rated operational current I_c /AC-15/AC-14 T_U : 70 °C at				Contacts		Rated control supply voltage U_s	DT	Cage Clamp terminals	PU (UNIT, SET, M)	PS*	PG	Weight per PU approx.
230 V	400 V	500 V	690 V	Version				Order No.	Price per PU			kg
A	A	A	A	NO	NC	V DC						

3RH11 contactor relays

Size S00

Cage Clamp terminals for all connections

6	3	2	1	2	2 ¹⁾	24 ²⁾ 110 ²⁾	▶	3RH11 22-2KB40 3RH11 22-2KF40	1 1	1 unit 1 unit	101 101	0.260 0.260
6	3	2	1	2	1 ³⁾	24 110	A A	3RH11 22-2KB40-0LA0 3RH11 22-2KF40-0LA0	1 1	1 unit 1 unit	101 101	0.290 0.290

¹⁾ It is not possible to mount an auxiliary switch block. A clearance of 10 mm is required for side-by-side mounting at ambient temperatures > 60 °C.

²⁾ Version without series resistor.

³⁾ One 4-pole auxiliary switch block according to EN 50005 can be mounted; no distance required up to 70 °C.

3RT, 3RH, 3TB, 3TC, 3TH, 3TK Contactors for Special Applications

Contactors with Extended Operating Range 0.7 ... 1.25 x U_s , for Railway Applications

3TH4 contactor relays

Overview

3TH4 contactor relays

EN 60947-4-1.

For requirements according to IEC 60077-1 and IEC 60077-2.

The contactors are finger-safe according to EN 50274. Terminal covers may have to be fitted onto the connecting bars, depending on the configuration with other devices.

Application

For operation in plants which are subject both to considerable variations in the control voltage and to high ambient temperatures, e. g. in railway applications.

Selection and ordering data

For screw and snap-on mounting onto 35 mm standard mounting rail
Solenoid coil fitted with varistor



3TH4

Con- tacts	Rated operational current $I_e/AC-15/AC-14$				Contacts ¹⁾		Rated control supply voltage U_s	DT	Screw terminals 	PU (UNIT, SET, M)	PS*	PG	Weight per PU approx.	
	230 V	400 V	500 V	690 V	Ident. No. acc. to EN 50011	Version 								
Number	A	A	A	A		NO	NC	V DC	Order No.	Price per PU			kg	
3TH42 contactor relays · DC operation · DC solenoid system														
8	10	6	4	2	44E	4	4	24 110	▶ ▶	3TH42 44-0LB4 3TH42 44-0LF4	1 1	1 unit 1 unit	101 101	0.670 0.670
					53E	5	3	24 110	▶ ▶	3TH42 53-0LB4 3TH42 53-0LF4	1 1	1 unit 1 unit	101 101	0.670 0.670
					62E	6	2	24 110	▶ ▶	3TH42 62-0LB4 3TH42 62-0LF4	1 1	1 unit 1 unit	101 101	0.670 0.670

For accessories, see page 3/124.

¹⁾ Contacts not extendable.

3RT, 3RH, 3TB, 3TC, 3TH, 3TK Contactors for Special Applications

Contactors with Extended Operating Range $0.7 \dots 1.25 \times U_s$, for Railway Applications

3RT10 motor contactors, 5.5 ... 45 kW

Overview

DC operation

IEC 60947-4-1, EN 60947-4-1 (VDE 0660, Part 102), for requirements according to IEC 60077-1 and IEC 60077-2.

The contactors are finger-safe according to EN 50274 (exception: series resistors S0 to S3). The contactors are available with both Cage Clamp and screw connection. The size S00 contactors have Cage Clamp terminals for all connections. The auxiliary conductor and coil terminals of sizes S0 to S3 are all Cage Clamp terminals.

Ambient temperature

The permissible ambient temperature for operation of the contactors (across the full coil operating range) is -40 °C to $+70 \text{ °C}$.

Uninterrupted duty at temperatures $> +60 \text{ °C}$ reduces the mechanical endurance, the current-carrying capacity of the conducting paths and the switching frequency.

Dimensions

Attaching resistors increases the width of contactor sizes S0 to S3 (see [Dimensional drawings](#)).

Application

For operation in installations which are subject both to considerable variations in the control voltage and to high ambient temperatures, e. g. railway applications under extreme climatic conditions, rolling mills, etc.

Control and auxiliary circuits

The solenoid coils of the contactors have an extended operating range from 0.7 to $1.25 \times U_s$ and are fitted as standard with varistors to provide protection against overvoltage. The opening delay is consequently 2 to 5 ms longer than for standard contactors.

3RT10 ..-2K.42-0LA0, 3RT10 ..-3K.44-0LA0

The DC solenoid systems of the contactors are modified (to hold-in coil) by means of a series resistor.

The size S00 contactors are supplied prewired with a plug-on module containing the series resistor. The varistor is integrated. A 4-pole auxiliary switch block (according to EN 50005) can be fitted additionally.

The size S0 to S3 contactors are equipped on the front with an auxiliary switch block with 2 NO + 2 NC contacts. The separate series resistor, which is attached laterally next to the contactor on the 35 mm standard mounting rail, is fitted with connecting cables for mounting onto contactors. A circuit diagram showing the terminals is stuck onto each contactor. One NC of the auxiliary contacts is required for the series resistor function. The selection and ordering data shows the number of additional, unsigned auxiliary contacts. It is only possible to extend the number of auxiliary contacts with size S00.

Mounting

At ambient temperatures up to 70 °C , the size S00 contactors and contactor relays are allowed to be mounted side by side. The resistor module of the size S0 to S3 contactors must be mounted to the left of the contactor owing to the prefabricated connecting cables.

3RT10 17-2K.4., 3RT10 2.-3K.40

These contactors have an extended operating range from 0.7 to $1.25 \times U_s$; the coils are fitted with varistors as standard. An additional series resistor is not required.

Please note:

- Size S00: It is not possible to mount an auxiliary switch block.
- Size S0: Up to two single-pole auxiliary switch blocks can be mounted.

At ambient temperatures $> 60 \text{ °C} \leq 70 \text{ °C}$, a clearance of 10 mm is required when they are mounted side by side.

3RT10 contactors with contactor control unit, extended operating range

Control and auxiliary circuits

The solenoid coils of the contactors have an extended operating range from 0.7 to $1.25 \times U_s$ and are fitted as standard with varistors to provide protection against overvoltage. The opening delay is consequently 2 ms to 5 ms longer than for standard contactors.

3RT10 ...-X.40-0LA2

The contactors are energized via upstream control electronics which ensure the coil operating range of 0.7 to $1.25 \times U_s$ at an ambient temperature of 70 °C . They are supplied as complete units with a built-on contactor control unit. A varistor is integrated for damping opening surges in the coil.

The possibility of mounting auxiliary switches is the same as that for equivalent standard contactors.

Mounting

At ambient temperatures up to 70 °C , sizes S0 to S3 of these contactor versions are allowed to be mounted side by side.

Ambient temperature

The permissible ambient temperature for operation of the contactors (across the full coil operating range) is -40 °C to $+70 \text{ °C}$. Uninterrupted duty at temperatures $> +60 \text{ °C}$ reduces the mechanical endurance, the current-carrying capacity of the conducting paths and the switching frequency.

Dimensions

Because of the built-on contactor control unit, the height of the size S0 to S3 contactors increases by up to 34 mm (see [Dimensional drawings](#)).

3RT, 3RH, 3TB, 3TC, 3TH, 3TK Contactors for Special Applications

Contactors with Extended Operating Range 0.7 ... 1.25 x U_S, for Railway Applications

3RT10 motor contactors, 5.5 ... 45 kW

Selection and ordering data

DC operation · DC solenoid system

Cage Clamp terminals

For screw and snap-on mounting onto standard mounting rail

Solenoid coil fitted with varistor

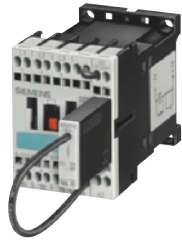

3RT10 17-2K.4.-0LA0



3RT10 2.-3K.40



3RT10 3.-3K.44-0LA0

Rated data AC-2 and AC-3 T _U : 70 °C	Operational current I _e at	Ratings of induction motors at	Auxiliary contacts	Version	Rated control supply voltage U _s	DT	Cage Clamp terminals	PU (UNIT, SET, M)	PS*	PG	Weight per PU approx.
400 V	230 V	400 V	500 V	690 V	NO NC	V DC	Order No.	Price per PU			kg

3RT10 contactors for switching motors

Size S00

Cage Clamp terminals for all connections

12	3	5.5	5.5	5.5	1 ¹⁾	--	24 ³⁾ 110 ³⁾	▶	3RT10 17-2KB41 3RT10 17-2KF41	1 1	1 unit 1 unit	101 101	0.260 0.260
12	3	5.5	5.5	5.5	--	1 ¹⁾	24 ³⁾ 110 ³⁾	▶	3RT10 17-2KB42 3RT10 17-2KF42	1 1	1 unit 1 unit	101 101	0.260 0.260
12	3	5.5	5.5	5.5	--	1 ²⁾	24 110	A B	3RT10 17-2KB42-0LA0 3RT10 17-2KF42-0LA0	1 1	1 unit 1 unit	101 101	0.280 0.280

Size S0

Cage Clamp terminals for coil terminals and auxiliary contacts

17	4	7.5	10	11	--	-- ⁴⁾	24 ³⁾ 110 ³⁾	▶	3RT10 25-3KB40 3RT10 25-3KF40	1 1	1 unit 1 unit	101 101	0.600 0.600
25	5.5	11	11	11	--	-- ⁴⁾	24 ³⁾ 110 ³⁾	▶	3RT10 26-3KB40 3RT10 26-3KF40	1 1	1 unit 1 unit	101 101	0.600 0.600
17	4	7.5	10	11	2	1 ⁵⁾	24 110	B B	3RT10 25-3KB44-0LA0 3RT10 25-3KF44-0LA0	1 1	1 unit 1 unit	101 101	0.760 0.760
25	5.5	11	11	11	2	1 ⁵⁾	24 110	B B	3RT10 26-3KB44-0LA0 3RT10 26-3KF44-0LA0	1 1	1 unit 1 unit	101 101	0.760 0.760

Size S2

Cage Clamp terminals for coil terminals and auxiliary contacts

32	7.5	15	18.5	18.5	2	1 ⁵⁾	24 110	B B	3RT10 34-3KB44-0LA0 3RT10 34-3KF44-0LA0	1 1	1 unit 1 unit	101 101	1.670 1.670
40	11	18.5	22	22	2	1 ⁵⁾	24 110	B B	3RT10 35-3KB44-0LA0 3RT10 35-3KF44-0LA0	1 1	1 unit 1 unit	101 101	1.670 1.670
50	15	22	30	22	2	1 ⁵⁾	24 110	B B	3RT10 36-3KB44-0LA0 3RT10 36-3KF44-0LA0	1 1	1 unit 1 unit	101 101	1.670 1.670

Size S3

Cage Clamp terminals for coil terminals and auxiliary contacts

65	18.5	30	37	43	2	1 ⁵⁾	24 110	B B	3RT10 44-3KB44-0LA0 3RT10 44-3KF44-0LA0	1 1	1 unit 1 unit	101 101	3.100 3.100
80	22	37	45	55	2	1 ⁵⁾	24 110	B B	3RT10 45-3KB44-0LA0 3RT10 45-3KF44-0LA0	1 1	1 unit 1 unit	101 101	3.100 3.100
95	22	45	55	55	2	1 ⁵⁾	24 110	B B	3RT10 46-3KB44-0LA0 3RT10 46-3KF44-0LA0	1 1	1 unit 1 unit	101 101	3.100 3.100

For spare parts, see page 3/101.

- 1) It is not possible to mount an auxiliary switch block. A clearance of 10 mm is required for side-by-side mounting at ambient temperatures > 60 °C.
- 2) One 4-pole auxiliary switch block according to EN 50005 can be mounted; no distance required up to 70 °C.
- 3) Version without series resistor.
- 4) Up to two single-pole auxiliary switch blocks can be mounted. A clearance of 10 mm is required for side-by-side mounting at ambient temperatures > 60 °C.
- 5) The number of auxiliary contacts cannot be increased; no clearance required up to 70 °C.

* You can order this quantity or a multiple thereof.

3RT, 3RH, 3TB, 3TC, 3TH, 3TK Contactors for Special Applications

Contactors with Extended Operating Range 0.7 ... 1.25 x U_s , for Railway Applications

3RT10 motor contactors, 5.5 ... 45 kW

DC operation - DC solenoid system
 For screw and snap-on mounting onto standard mounting
 rail - Contactor control unit
 Solenoid coil fitted with varistor

PU (UNIT, SET, M) = 1
 PS* = 1 unit
 PG = 101



3RT10 ...-3X.40-0LA2

Rated data AC-2 and AC-3 T_L : Up to 70 °C		Auxiliary contacts ¹⁾		Rated control supply voltage U_s	DT	Screw terminals		Weight per PU approx.	DT	Cage Clamp terminals		Weight per PU approx.
Rated operational current I_e up to 400 V	Rating of induction motors at 50 Hz 400 V	Ident. No.	Version			Order No.	Price per PU			Order No.	Price per PU	
A	kW			V DC				kg			kg	

For screw and snap-on mounting onto 35 mm standard mounting rail

Size S0

17	7.5	--	--	--	24	C	3RT10 25-1XB40-0LA2	0.640	B	3RT10 25-3XB40-0LA2	0.640
		--	--	--	110	B	3RT10 25-1XF40-0LA2	0.640	B	3RT10 25-3XF40-0LA2	0.640
25	11	--	--	--	24	B	3RT10 26-1XB40-0LA2	0.640	B	3RT10 26-3XB40-0LA2	0.640
		--	--	--	110	B	3RT10 26-1XF40-0LA2	0.640	B	3RT10 26-3XF40-0LA2	0.640

Size S2

32	15	--	--	--	24	B	3RT10 34-1XB40-0LA2	1.500	C	3RT10 34-3XB40-0LA2	1.500
		--	--	--	110	B	3RT10 34-1XF40-0LA2	1.500	B	3RT10 34-3XF40-0LA2	1.500
40	18.5	--	--	--	24	B	3RT10 35-1XB40-0LA2	1.500	C	3RT10 35-3XB40-0LA2	1.500
		--	--	--	110	B	3RT10 35-1XF40-0LA2	1.500	B	3RT10 35-3XF40-0LA2	1.500
50	22	--	--	--	24	B	3RT10 36-1XB40-0LA2	1.500	B	3RT10 36-3XB40-0LA2	1.500
		--	--	--	110	B	3RT10 36-1XF40-0LA2	1.500	B	3RT10 36-3XF40-0LA2	1.500

For screw and snap-on mounting onto 35 mm and 75 mm standard mounting rail

Size S3

65	30	--	--	--	24	B	3RT10 44-1XB40-0LA2	2.900	B	3RT10 44-3XB40-0LA2	2.900
		--	--	--	110	B	3RT10 44-1XF40-0LA2	2.900	B	3RT10 44-3XF40-0LA2	2.900
80	37	--	--	--	24	B	3RT10 45-1XB40-0LA2	2.900	B	3RT10 45-3XB40-0LA2	2.900
		--	--	--	110	B	3RT10 45-1XF40-0LA2	2.900	B	3RT10 45-3XF40-0LA2	2.900
95	45	--	--	--	24	B	3RT10 46-1XB40-0LA2	2.900	B	3RT10 46-3XB40-0LA2	2.900
		--	--	--	110	B	3RT10 46-1XF40-0LA2	2.900	B	3RT10 46-3XF40-0LA2	2.900

¹⁾ Auxiliary switch blocks mountable as standard contactors.

3RT, 3RH, 3TB, 3TC, 3TH, 3TK Contactors for Special Applications

Contactors with Extended Operating Range 0.7 ... 1.25 x U_s , for Railway Applications

3TB5 motor contactors, 55 ... 200 kW

Overview

EN 60947-4-1.

For requirements according to IEC 60077-1 and IEC 60077-2.

The contactors are finger-safe according to EN 50274. Terminal covers may have to be fitted onto the connecting bars, depending on the configuration with other devices.

Application

For operation in plants which are subject both to considerable variations in the control voltage and to high ambient temperatures, e. g. in railway applications.

Selection and ordering data

3TB50 to 3TB56 contactors
For screw fixing
Solenoid coil fitted with varistor

Size	Rated data AC-2 and AC-3					Auxiliary contacts ¹⁾		Rated control supply voltage U_s	DT	Screw terminals 	PU (UNIT, SET, M)	PS*	PG	Weight per PU approx.
	Operational current I_e at 400 V	Ratings of induction motors at				Version								
A	kW	kW	kW	kW	kW	NO	NC	V DC	Order No.	Price per PU				
Contactors for switching AC voltage														
DC operation · DC solenoid system														
6	110	37	55	75	90	2	1	24 110	D D	3TB50 17-0LB4 3TB50 17-0LF4	1 1	1 unit 1 unit	101 101	6.600 6.600
8	170	55	90	110	132	2	1	24 110	D D	3TB52 17-0LB4 3TB52 17-0LF4	1 1	1 unit 1 unit	101 101	9.300 9.300
10	250	75	132	160	200	2	1	24 110	D D	3TB54 17-0LB4 3TB54 17-0LF4	1 1	1 unit 1 unit	101 101	16.800 16.800
12	400	115	200	255	355	2	1	110	D	3TB56 17-0LF4	1	1 unit	101	19.800

¹⁾ The number of auxiliary contacts cannot be increased.

3RT, 3RH, 3TB, 3TC, 3TH, 3TK Contactors for Special Applications

Contactors with Extended Operating Range 0.7 ... 1.25 x U_s , for Railway Applications

3TC contactors for switching DC voltage, 2-pole

Overview

EN 60947-4-1.

For requirements according to IEC 60077-1 and IEC 60077-2.

The contactors are finger-safe according to EN 50274 (exception: series resistor). Terminal covers may have to be fitted onto the connecting bars, depending on the configuration with other devices.

Application

For operation in plants which are subject both to considerable variations in the control voltage and to high ambient temperatures, e. g. in railway applications.

Selection and ordering data

3TC44: for screw and snap-on mounting onto

35 mm standard mounting rail

3TC48 to 3TC56: for screw fixing

Solenoid coil fitted with varistor



3TC48

Size	Utilization category	Rated operational current I_e at 750 V	Rated power of AC loads at				Auxiliary contacts ¹⁾		Rated control supply voltage U_s	DT	Screw terminals		PU (UNIT, SET, M)	PS*	PG	Weight per PU approx.
			220 V	440 V	600 V	750 V	Version	Order No.			Price per PU					
			A	kW	kW	kW	kW	NO	NC	V DC						
Contactors for switching DC voltage DC operation · DC solenoid system																
2	DC-1	32	7	14	19.2	24	2	1	24	B	3TC44 17-0LB4		1	1 unit	101	1.380
	DC-3/DC-5	7.5	5	9	9	4			110	C	3TC44 17-0LF4		1	1 unit	101	1.380
4	DC-1	75	16.5	33	45	56	2	1	24	C	3TC48 17-0LB4		1	1 unit	101	4.900
	DC-3/DC-5	75	13	27	38	45			110	C	3TC48 17-0LF4		1	1 unit	101	4.900
8	DC-1	170	48	97	132	165	2	1	24	C	3TC52 17-0LB4		1	1 unit	101	10.800
	DC-3/DC-5	170	41	82	110	110			110	C	3TC52 17-0LF4		1	1 unit	101	10.800
12	DC-1	400	88	176	240	300	2	1	24	C	3TC56 17-0LB4		1	1 unit	101	19.500
	DC-3/DC-5	400	70	140	200	250			110	D	3TC56 17-0LF4		1	1 unit	101	19.500

¹⁾ The number of auxiliary contacts cannot be increased.

3RT, 3RH, 3TB, 3TC, 3TH, 3TK Contactors for Special Applications

3TC Contactors for Switching DC Voltage

1- and 2-pole, 32 ... 400 A

Overview

3TC4 and 3TC5

EN 60947-4-1 (VDE 0660 Part 102).

The contactors are finger-safe according to EN 50274.

Terminal covers may have to be fitted onto the connecting bars, depending on the configuration with other devices.

The DC motor ratings given in the tables are applicable to the DC-3 and DC-5 utilization categories with two-pole switching of the load or with the two conducting paths of the contactor connected in series.

One contactor conducting path can switch full power up to 220 V. The ratings for higher voltages are available on request.

3TC7

EN 60947-4-1 (VDE 0660 Part 102).

The contactors are suitable for use in any climate. They are suitable for switching and controlling DC motors as well as all other DC loads. The electromagnetic excitation is designed for a particularly wide coil operating range.

It is between 0.7 or 0.8 to $1.2 \times U_s$.

3TC74 contactors can be used at up to 750 V/400 A and 50 Hz in AC-1 operation.

Application

The contactors are suitable for switching and controlling DC motors as well as all other DC circuits.

A version with an especially large coil operating range is available for operation in electrically driven vehicles and in switch-gear with significant fluctuations in the operational voltage (see [page 3/65](#)).

3RT, 3RH, 3TB, 3TC, 3TH, 3TK Contactors for Special Applications

3TC Contactors for Switching DC Voltage

1- and 2-pole, 32 ... 400 A

Selection and ordering data



Size	Rated data DC-3 and DC-5 ¹⁾						Auxiliary contacts ²⁾		Rated control supply voltage U_s	DT	Screw terminals	PU (UNIT, SET, M)	PS*	PG	Weight per PU approx.
	Operational current I_e ³⁾	Ratings of DC motors at					Version								
A	kW	kW	kW	kW	kW	kW	NO	NC	V	Order No.	Price per PU				
		110 V	220 V	440 V	600 V	750 V									kg

3TC44 to 3TC56 two-pole contactors

DC operation

Screw and snap-on mounting onto 35 mm standard mounting rail

2	32	2.5	5	9	9	4	2	2	24 DC		▶ 3TC44 17-0AB4	1	1 unit	101	1.100
									110 DC		▶ 3TC44 17-0AF4	1	1 unit	101	1.100
									220 DC		▶ 3TC44 17-0AM4	1	1 unit	101	1.100

Screw fixing

4	75	6.5	13	27	38	45	2	2	24 DC	A	3TC48 17-0AB4	1	1 unit	101	4.700
									110 DC	A	3TC48 17-0AF4	1	1 unit	101	4.700
									220 DC	A	3TC48 17-0AM4	1	1 unit	101	4.700
8	220 ⁴⁾	20	41	82	110	110	2	2	24 DC	C	3TC52 17-0AB4	1	1 unit	101	10.800
									110 DC	C	3TC52 17-0AF4	1	1 unit	101	10.800
									220 DC	C	3TC52 17-0AM4	1	1 unit	101	10.800
12	400	35	70	140	200	250	2	2	24 DC	C	3TC56 17-0AB4	1	1 unit	101	19.500
									110 DC	C	3TC56 17-0AF4	1	1 unit	101	19.500
									220 DC	C	3TC56 17-0AM4	1	1 unit	101	19.500

AC operation, 50 Hz

Screw and snap-on mounting onto 35 mm standard mounting rail

2	32	2.5	5	9	9	4	2	2	220 / 230 AC ⁵⁾		▶ 3TC44 17-0BP0	1	1 unit	101	0.700
									110 / 110 AC		▶ 3TC44 17-0BF0	1	1 unit	101	0.700

Screw fixing

4	75	6.5	13	27	38	45	2	2	220 / 230 AC ⁵⁾	A	3TC48 17-0BP0	1	1 unit	101	3.500
									110 AC	C	3TC48 17-0BF0	1	1 unit	101	3.500
8	220 ⁴⁾	20	41	82	110	110	2	2	220 / 230 AC ⁵⁾	A	3TC52 17-0BP0	1	1 unit	101	7.200
									110 AC	C	3TC52 17-0BF0	1	1 unit	101	7.200
12	400	35	70	140	200	250	2	2	220 / 230 AC ⁵⁾	C	3TC56 17-0BP0	1	1 unit	101	14.500
									110 AC	C	3TC56 17-0BF0	1	1 unit	101	14.500

For more rated control supply voltages U_s , see page 3/68.

¹⁾ For permissible load for utilization category DC-1 see Technical Information LV 1 T → Technical specifications.

²⁾ The fitting of auxiliary switches cannot be altered on DC-operated contactors.

³⁾ The following rated operational currents are permitted for reversing duty with 3TC44 to 3TC56 contactors:

Contactor	Rated operational voltage	
Type	110 V, 220 V	440 V
3TC44	32 A	7 A
3TC48	75 A	75 A
3TC52	170 A	170 A
3TC56	400 A	400 A

⁴⁾ At > 600 V: $I_e = 170$ A.

⁵⁾ Operating range at 220 V: 0.85 to 1.15 × U_s .

3RT, 3RH, 3TB, 3TC, 3TH, 3TK Contactors for Special Applications

3TC Contactors for Switching DC Voltage

1- and 2-pole, 32 ... 400 A



3TC74

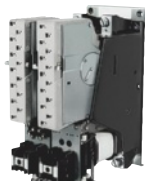

3TC78

Size	Rated data DC-3 and DC-5 ¹⁾								Auxiliary contacts ²⁾		Rated control supply voltage U_s	DT	Screw terminals	PU (UNIT, SET, M)	PS*	PG	Weight per PU approx.
	Operational current I_e	Ratings of DC motors at							Version								
A	kW	kW	kW	kW	kW	kW	kW	kW	NO	NC	V						kg

3TC74 1-pole contactors · Operational voltage up to 750 V

DC operation

12	400	35	70	140	200	250	--	--	4	4	24 DC 110 DC	C	3TC74 14-0EB	1	1 unit	101	10.800
												C	3TC74 14-0EF	1	1 unit	101	10.800

AC operation, 50 Hz

12	400	35	70	140	200	250	--	--	4	4	230 / 220 AC ³⁾	C	3TC74 14-1CM	1	1 unit	101	10.800
----	-----	----	----	-----	-----	-----	----	----	---	---	----------------------------	---	---------------------	---	--------	-----	--------

3TC78 2-pole contactors · Operational voltage up to 1500 V

DC operation

12	400	35	70	140	200	250	400	500	4	4	24 DC 110 DC	C	3TC78 14-0EB	1	1 unit	101	22.500
												C	3TC78 14-0EF	1	1 unit	101	22.500

AC operation, 50 Hz

12	400	35	70	140	200	250	400	500	4	4	230 / 220 AC ³⁾	C	3TC78 14-1CM	1	1 unit	101	23.800
----	-----	----	----	-----	-----	-----	-----	-----	---	---	----------------------------	---	---------------------	---	--------	-----	--------

For more rated control supply voltages U_s , see below.
For spare parts, see page 3/129.

¹⁾ For the permissible load for utilization category DC-1, see "Technical specifications".

²⁾ The fitting of auxiliary switches cannot be altered on DC-operated contactors.

³⁾ Upper operating range limit at 230 V: $1.14 \times U_s$.

Rated control supply voltages (the 10th and 11th position of the order number must be changed)

Contactor type	3TC44	3TC48	3TC52/56	3TC74/78
Rated control supply voltage U_s				
AC operation				
Solenoid coils for 50 Hz				
24 V AC	B0	B0	--	--
110 V AC	F0	F0	F0	--
230/220 V AC	P0 ¹⁾	P0 ¹⁾	P0 ¹⁾	M ²⁾
240 V AC	U0	U0	--	--
AC operation				
Solenoid coils for 50/60 Hz				
24 V AC	C2	--	--	--
110 V AC	G2	--	--	--
120 V AC	K2	--	--	--
220 V AC	N2	--	--	--
230 V AC	L2	--	--	--
DC operation				
24 V DC	B4	B4	B4	B
48 V DC	W4	W4	--	--
60 V DC	E4	E4	--	--
110 V DC	F4	F4	F4	F
125 V DC	G4	G4	--	--
220 V DC	M4	M4	M4	M
230 V DC	P4	P4	--	--

¹⁾ Operating range at 220 V or 380 V: 0.85 to $1.15 \times U_s$; lower operating range limit according to IEC 60947.

²⁾ Upper operating range limit at 230 V: $1.14 \times U_s$.

Overview

The SIRIUS generation of controls is a complete, modular system family, logically designed right down to the last detail, from the basic units to the accessories.

Contactor relays and coupling relays
Size S00 with accessories

AC and DC operation

IEC 60947, EN 60947 (VDE 0660)

The 3RH1 contactor relays are suitable for use in any climate. They are finger-safe according to EN 50274.

The 3RH1 contactor relays have screw or Cage Clamp terminals. Four contacts are available in the basic unit.

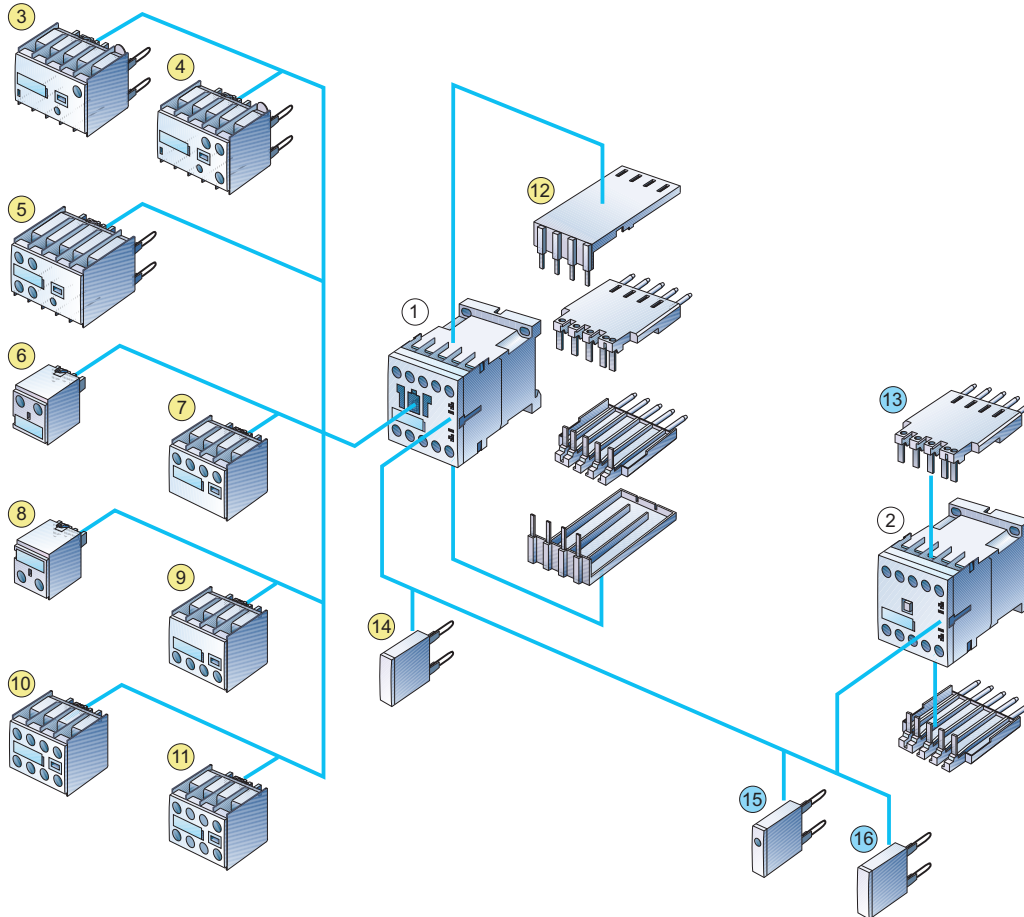

- ① Contactor relay, see page 3/70
- ② Coupling relay for auxiliary circuits, see page 3/78
- ③ Solid-state time-delay block, ON-delay, see page 3/106
- ④ Solid-state time-delay block, OFF-delay, see page 3/106
- ⑤ Auxiliary switch block with solid-state time delay, see page 3/105 (versions with ON or OFF-delay)
- ⑥ 1-pole auxiliary switch block, cable entry from above, see page 3/100
- ⑦ 2-pole auxiliary switch block, cable entry from above, see page 3/100
- ⑧ 1-pole auxiliary switch block, cable entry from below, see page 3/100
- ⑨ 2-pole auxiliary switch block, cable entry from below, see page 3/100
- ⑩ 4-pole auxiliary switch block, see page 3/100 (terminal designations according to EN 50011 or EN 50005)
- ⑪ 2-pole auxiliary switch block, standard version or solid-state compatible version, see page 3/100 (terminal designations according to EN 50005)
- ⑫ Solder pin adapter for contactor relays with 4-pole auxiliary switch block, see page 3/111
- ⑬ Solder pin adapter for contactor relays and coupling relays, see page 3/110
- ⑭ Additional load module for increasing the permissible residual current, see page 3/109
- ⑮ Surge suppressor with LED, see page 3/108
- ⑯ Surge suppressor without LED, see page 3/108

Rated control supply voltages
(the 10th and 11th position of the order number must be changed)

	Contactor type	3RH11
Rated control supply voltage U_s	Control supply voltage at	

AC operation

Solenoid coils for AC 50/60 and 60 Hz

50/60 Hz ¹⁾	60 Hz	
24 V AC	--	B0
42 V AC	--	D0
48 V AC	--	H0
110 V AC	--	F0
220 V AC	--	N2
230 V AC	--	P0
400 V AC	--	V0

Solenoid coils for AC 50/60 and 60 Hz (for Japan²⁾)

100 V AC	110 V AC	G6
200 V AC	220 V AC	N6
400 V AC	440 V AC	R6

Solenoid coils for AC 50 and 60 Hz (for USA and Canada³⁾)

50 Hz	60 Hz	
110 V AC	120 V AC	K6
220 V AC	240 V AC	P6

DC operation

12 V DC	A4
24 V DC	B4
42 V DC	D4
48 V DC	W4
60 V DC	E4
110 V DC	F4
125 V DC	G4
220 V DC	M4
230 V DC	P4

¹⁾ Coil operating range
at 50 Hz: 0.8 to 1.1 x U_s
at 60 Hz: 0.85 to 1.1 x U_s .

²⁾ Coil operating range
at 50/60 Hz: 0.85 to 1.1 x U_s
at 60 Hz: 0.8 to 1.1 x U_s .

³⁾ Coil operating range
at 50 Hz: 0.85 to 1.1 x U_s
at 60 Hz: 0.8 to 1.1 x U_s .

3RH, 3TH Contactor Relays

3RH14 latched contactor relays, 4-pole

Overview

AC and DC operation

IEC 60947, EN 60947 (VDE 0660).

The terminal designations comply with EN 50011.

The contactor coil and the coil of the release solenoid are both designed for uninterrupted duty.

The number of auxiliary contacts can be extended by means of auxiliary switch blocks (up to 4 poles).

RC elements, varistors diodes or diode assemblies can be fitted to both coils from the front for damping opening surges in the coil.

The contactor relay can also be switched on and released manually (for minimum actuating times, see "Technical specifications").

Selection and ordering data



3RH14 ..-1...

Rated operational current I_e /AC-15/AC-14 at 230 V	Contacts		Rated control supply voltage U_s	DT	Screw terminals	PU (UNIT, SET, M)	PS*	PG	Weight per PU approx.
	Ident. No. acc. to EN 50011	Version							
A		NO NC	V						kg

With screw terminals · for screw and snap-on mounting onto 35 mm standard mounting rail

AC operation

6	40 E	4	--	AC 50/60 Hz ¹⁾		DT	Order No.	PU	PS*	PG	Weight per PU approx.
				Rated current	Rated voltage						
				24	B	3RH14 40-1AB00	1	1 unit	101	0.380	
				42	B	3RH14 40-1AD00	1	1 unit	101	0.380	
				110	B	3RH14 40-1AF00	1	1 unit	101	0.380	
				230	A	3RH14 40-1AP00	1	1 unit	101	0.380	
	31 E	3	1	24	B	3RH14 31-1AB00	1	1 unit	101	0.380	
				42	B	3RH14 31-1AD00	1	1 unit	101	0.380	
				110	B	3RH14 31-1AF00	1	1 unit	101	0.380	
				230	B	3RH14 31-1AP00	1	1 unit	101	0.380	
	22 E	2	2	24	B	3RH14 22-1AB00	1	1 unit	101	0.380	
				42	B	3RH14 22-1AD00	1	1 unit	101	0.380	
				110	B	3RH14 22-1AF00	1	1 unit	101	0.380	
				230	▶ B	3RH14 22-1AP00	1	1 unit	101	0.380	

DC operation · DC solenoid system

6	40 E	4	--	DC		DT	Order No.	PU	PS*	PG	Weight per PU approx.
				Rated current	Rated voltage						
				24	▶ B	3RH14 40-1BB40	1	1 unit	101	0.500	
				110	B	3RH14 40-1BF40	1	1 unit	101	0.500	
				220	B	3RH14 40-1BM40	1	1 unit	101	0.500	
	31 E	3	1	24	B	3RH14 31-1BB40	1	1 unit	101	0.500	
				110	B	3RH14 31-1BF40	1	1 unit	101	0.500	
				220	B	3RH14 31-1BM40	1	1 unit	101	0.500	
	22 E	2	2	24	▶ B	3RH14 22-1BB40	1	1 unit	101	0.500	
				110	B	3RH14 22-1BF40	1	1 unit	101	0.500	
				220	B	3RH14 22-1BM40	1	1 unit	101	0.500	

For accessories, see page 3/100 and 3/102.

¹⁾ Coil operating range
at 50 Hz: 0.8 to 1.1 x U_s
at 60 Hz: 0.85 to 1.1 x U_s .

Overview

AC and DC operation

IEC 60947 and EN 60947 (VDE 0660).

The 3TH42/3TH43 contactor relays are suitable for use in any climate. They are finger-safe according to EN 50274.

Terminal designations according to EN 50011

In terms of their terminal designations, identification numbers and identification letters, the 3TH42/3TH43 contactor relays conform to the standard EN 50011 for "Specific contactor relays".

Selection and ordering data



3TH42 ...-0...

Contacts	Rated operational current $I_{ed}/AC-15/AC-14$ at				Contacts	DT	Screw terminals	PU (UNIT, SET, M)	PS*	PG	Weight per PU approx.
	230/220 V	400/380 V	500 V	690/660 V							
Number	A	A	A	A							kg
					NO	NC	NO	NC			

With screw terminals - for screw and snap-on mounting onto 35 mm standard mounting rail

AC operation, rated control supply voltage $U_s = AC 50 Hz 230/220 V^{1)}$

8	10	6	4	2	80 E	8	--	--	--	▶	3TH42 80-0AP0	1	1 unit	101	0.420
					71 E	7	1	--	--	▶	3TH42 71-0AP0	1	1 unit	101	0.420
					62 E	6	2	--	--	D	3TH42 62-0AP0	1	1 unit	101	0.420
					53 E	5	3	--	--	▶	3TH42 53-0AP0	1	1 unit	101	0.420
					44 E	4	4	--	--	▶	3TH42 44-0AP0	1	1 unit	101	0.420
					44 E, U	3	3	1	1	▶	3TH42 93-0AP0	1	1 unit	101	0.420

DC operation - DC solenoid system, rated control supply voltage $U_s = 24 V DC$

8	10	6	4	2	80 E	8	--	--	--	▶	3TH42 80-0BB4	1	1 unit	101	0.670
					71 E	7	1	--	--	▶	3TH42 71-0BB4	1	1 unit	101	0.670
					62 E	6	2	--	--	▶	3TH42 62-0BB4	1	1 unit	101	0.670
					53 E	5	3	--	--	▶	3TH42 53-0BB4	1	1 unit	101	0.670
					44 E	4	4	--	--	▶	3TH42 44-0BB4	1	1 unit	101	0.670
					44 E, U	3	3	1	1	▶	3TH42 93-0BB4	1	1 unit	101	0.670

For accessories, see page 3/124.

Spare parts

Solenoid coils:

AC operation: 3TY7 403-0A.

DC operation: 3TY4 803-0B.

(voltages on request)

Contacts:

The contacts cannot be replaced on 3TH42 contactor relays.

¹⁾ Operating range at 220 V: 0.85 to 1.1 x U_s ;
lower operating range limit according to IEC 60947.

3RH, 3TH Contactor Relays

3TH4 contactor relays, 8- and 10-pole



Contacts		Rated operational current I_e /AC-15/AC-14 at				Contacts		DT	Screw terminals	PU (UNIT, SET, M)	PS*	PG	Weight per PU approx.
		230 V	400 V	500 V	690 V	Ident. No. acc. to EN 50011	Version		Order No.	Price per PU			kg
Number	A	A	A	A									

With screw terminals · for screw and snap-on mounting onto 35 mm standard mounting rail

AC operation, rated control supply voltage $U_s = AC 50 Hz 230/220 V^1)$

10	10	6	4	2	100 E	10	--	--	--	▶	3TH43 10-0AP0	1	1 unit	101	0.480
					91 E	9	1	--	--	▶	3TH43 91-0AP0	1	1 unit	101	0.480
					82 E	8	2	--	--	▶	3TH43 82-0AP0	1	1 unit	101	0.480
					73 E	7	3	--	--	▶	3TH43 73-0AP0	1	1 unit	101	0.480
					73 E,U	6	2	1	1	▶	3TH43 46-0AP0	1	1 unit	101	0.480
					64 E	6	4	--	--	▶	3TH43 64-0AP0	1	1 unit	101	0.480
					55 E	5	5	--	--	▶	3TH43 55-0AP0	1	1 unit	101	0.480
					55 E,U	4	4	1	1	▶	3TH43 94-0AP0	1	1 unit	101	0.480

DC operation · DC solenoid system, rated control supply voltage $U_s = 24 V DC$

10	10	6	4	2	100 E	10	--	--	--	▶	3TH43 10-0BB4	1	1 unit	101	0.710
					91 E	9	1	--	--	▶	3TH43 91-0BB4	1	1 unit	101	0.710
					82 E	8	2	--	--	▶	3TH43 82-0BB4	1	1 unit	101	0.710
					73 E	7	3	--	--	▶	3TH43 73-0BB4	1	1 unit	101	0.710
					73 E, U	6	2	1	1	▶	3TH43 46-0BB4	1	1 unit	101	0.710
					64 E	6	4	--	--	▶	3TH43 64-0BB4	1	1 unit	101	0.710
					55 E	5	5	--	--	▶	3TH43 55-0BB4	1	1 unit	101	0.710
					55 E, U	4	4	1	1	▶	3TH43 94-0BB4	1	1 unit	101	0.710

For accessories, see page 3/124.

¹⁾ Operating range at 220 V: 0.85 to 1.1 x U_s , lower operating range limit according to IEC 60947.

Spare parts

Solenoid coils:
AC operation: 3TY7 403-0A..
DC operation: 3TY4 803-0B..

Contacts:

The contacts cannot be replaced on 3TH43 contactor relays.

Rated control supply voltages (the 10th and 11th position of the order number must be changed)

Rated control supply voltage U_s	Contactor type	3TH42/3TH43
Control supply voltage at		

AC operation

Solenoid coils for AC 50 Hz

50 Hz	60 Hz	
24 V AC	29 V AC	B0
36 V AC	42 V AC	G0
42 V AC	50 V AC	D0
48 V AC	58 V AC	H0
60 V AC	72 V AC	E0
110 V AC	132 V AC	F0
125/127 V AC	150/152 V AC	L0
230/220 V AC	276 V AC	P0 ¹⁾
240 V AC	288 V AC	U0
400/380 V AC	480/460 V AC	V0 ¹⁾
415 V AC	500 V AC	R0
500 V AC	600 V AC	S0

For Japan

100 V AC	100-110 V AC	G6 ²⁾
200 V AC	200-220 V AC	N6 ²⁾

For USA and Canada

110 V AC	120 V AC	K6 ²⁾
220 V AC	240 V AC	P6 ²⁾

¹⁾ Operating range at 220 V or 380 V: 0.85 to 1.1 x U_s .

²⁾ Operating range at 60 Hz: 0.85 to 1.1 x U_s .

Rated control supply voltage U_s	Contactor type	3TH42/3TH43

Solenoid coils for AC 50 and 60 Hz

50/60 Hz	
24 V AC	C2
42 V AC	D2
110 V AC	G2
115 V AC	J2
120 V AC	K2
220 V AC	N2
230 V AC	L2
240 V AC	P2
440 V AC	R2

DC operation

12 V DC	A4
24 V DC	B4
30 V DC	C4
36 V DC	V4
42 V DC	D4
48 V DC	W4
60 V DC	E4
110 V DC	F4
125 V DC	G4
220 V DC	M4
230 V DC	P4
240 V DC	Q4

* You can order this quantity or a multiple thereof.

Overview

AC and DC operation

IEC 60947 (VDE 0660).

The terminal designations comply with EN 50011.

3TH2 contactor relays

The 3TH2 contactor relays are suitable for use in any climate.

The contactor relays with screw terminal are finger-safe according to EN 50274.

3TH27 latched contactor relays

The contactor coil and the coil of the release solenoid are both designed for uninterrupted duty.

RC elements, varistors diodes or diode assemblies can be fitted to both coils from the front for damping opening surges in the coil.

The contactor relay can also be switched on and released manually.

3RH, 3TH Contactor Relays

3TH2 contactor relays, 4- and 8-pole

Selection and ordering data

Contacts	Rated operational current I_e /AC-15/AC-14 at				Contacts	DT	Order No.	Price per PU	PU (UNIT, SET, M)	PS*	PG	Weight per PU approx.
	230/ 220 V	400/ 380 V	500 V	690/ 660 V								
Number	A	A	A	A								kg
						NO NC						

Contactor relays with screw terminals for screw and snap-on mounting onto 35 mm standard mounting rail



3TH20 ...-0A...

AC operation

Number	A	A	A	A	Ident. No. acc. to EN 50011	Version	DT
4	4	3	2	1	40E 31E 22E	4 -- 3 1 2 2	A A A

Screw terminals

Order No.	Price per PU	PU (UNIT, SET, M)	PS*	PG	Weight per PU approx.
3TH20 40-0AP0		1	1 unit	101	0.200
3TH20 31-0AP0		1	1 unit	101	0.200
3TH20 22-0AP0		1	1 unit	101	0.200

DC operation · DC solenoid system

Number	A	A	A	A	Ident. No. acc. to EN 50011	Version	DT
4	4	3	2	1	40E 31E 22E	4 -- 3 1 2 2	A A A

Order No.	Price per PU	PU (UNIT, SET, M)	PS*	PG	Weight per PU approx.
3TH20 40-0BB4		1	1 unit	101	0.220
3TH20 31-0BB4		1	1 unit	101	0.220
3TH20 22-0BB4		1	1 unit	101	0.220

Contactor relays with 6.3 mm x 0.8 mm flat connectors



3TH20 ...-3...

AC operation

For screw and snap-on mounting onto 35 mm standard mounting rail

Number	A	A	A	A	Ident. No. acc. to EN 50011	Version	DT
4	4	3	2	--	40E 31E 22E	4 -- 3 1 2 2	C C C

Flat connectors

Order No.	Price per PU	PU (UNIT, SET, M)	PS*	PG	Weight per PU approx.
3TH20 40-3AP0		1	1 unit	101	0.170
3TH20 31-3AP0		1	1 unit	101	0.170
3TH20 22-3AP0		1	1 unit	101	0.170

For screw fixing (diagonal)

Number	A	A	A	A	Ident. No. acc. to EN 50011	Version	DT
4	4	3	2	--	40E 31E 22E	4 -- 3 1 2 2	C C C

Order No.	Price per PU	PU (UNIT, SET, M)	PS*	PG	Weight per PU approx.
3TH20 40-7AP0		1	1 unit	101	0.170
3TH20 31-7AP0		1	1 unit	101	0.170
3TH20 22-7AP0		1	1 unit	101	0.170

DC operation · DC solenoid system

For screw and snap-on mounting onto 35 mm standard mounting rail

Number	A	A	A	A	Ident. No. acc. to EN 50011	Version	DT
4	4	3	2	--	40E 31E 22E	4 -- 3 1 2 2	C C C

Order No.	Price per PU	PU (UNIT, SET, M)	PS*	PG	Weight per PU approx.
3TH20 40-3BB4		1	1 unit	101	0.190
3TH20 31-3BB4		1	1 unit	101	0.190
3TH20 22-3BB4		1	1 unit	101	0.190

For screw fixing (diagonal)

Number	A	A	A	A	Ident. No. acc. to EN 50011	Version	DT
4	4	3	2	--	40E 31E 22E	4 -- 3 1 2 2	C C C

Order No.	Price per PU	PU (UNIT, SET, M)	PS*	PG	Weight per PU approx.
3TH20 40-7BB4		1	1 unit	101	0.190
3TH20 31-7BB4		1	1 unit	101	0.190
3TH20 22-7BB4		1	1 unit	101	0.190

Contactor relays with solder pin connections for printed circuit boards



3TH20 ...-6...

AC operation

For screw fixing (diagonal)

Number	A	A	A	A	Ident. No. acc. to EN 50011	Version	DT
4	4	3	2	--	40E 31E 22E	4 -- 3 1 2 2	C C C

Solder pin connections

Order No.	Price per PU	PU (UNIT, SET, M)	PS*	PG	Weight per PU approx.
3TH20 40-6AP0		1	1 unit	101	0.170
3TH20 31-6AP0		1	1 unit	101	0.170
3TH20 22-6AP0		1	1 unit	101	0.170

DC operation · DC solenoid system

For screw fixing (diagonal)

Number	A	A	A	A	Ident. No. acc. to EN 50011	Version	DT
4	4	3	2	--	40E 31E 22E	4 -- 3 1 2 2	C C C

Order No.	Price per PU	PU (UNIT, SET, M)	PS*	PG	Weight per PU approx.
3TH20 40-6BB4		1	1 unit	101	0.190
3TH20 31-6BB4		1	1 unit	101	0.190
3TH20 22-6BB4		1	1 unit	101	0.190

Contactor relays with permanently mounted auxiliary switch blocks with screw terminals, width 45 mm for screw and snap-on mounting onto 35 mm standard mounting rail



3TH22 ...-0A...

AC operation

Number	A	A	A	A	Ident. No. acc. to EN 50011	Version	DT
8	4	3	2	--	80E 71E 62E 53E 44E	8 0 7 1 6 2 5 3 4 4	C C C C C

Screw terminals

Order No.	Price per PU	PU (UNIT, SET, M)	PS*	PG	Weight per PU approx.
3TH22 80-0AP0		1	1 unit	101	0.240
3TH22 71-0AP0		1	1 unit	101	0.240
3TH22 62-0AP0		1	1 unit	101	0.240
3TH22 53-0AP0		1	1 unit	101	0.240
3TH22 44-0AP0		1	1 unit	101	0.240

DC operation · DC solenoid system

Number	A	A	A	A	Ident. No. acc. to EN 50011	Version	DT
8	4	3	2	--	80E 71E 62E 53E 44E	8 0 7 1 6 2 5 3 4 4	C C C C C

Order No.	Price per PU	PU (UNIT, SET, M)	PS*	PG	Weight per PU approx.
3TH22 80-0BB4		1	1 unit	101	0.260
3TH22 71-0BB4		1	1 unit	101	0.260
3TH22 62-0BB4		1	1 unit	101	0.260
3TH22 53-0BB4		1	1 unit	101	0.260
3TH22 44-0BB4		1	1 unit	101	0.260

For accessories, see page 3/125.

* You can order this quantity or a multiple thereof.

3RH, 3TH Contactor Relays

3TH2 contactor relays, 4- and 8-pole

Con- tacts	Rated operational current I_e /AC-15/AC-14 at				Contacts		DT	Screw terminals 	PU (UNIT, SET, M)	PS*	PG	Weight per PU approx.
	230/ 220 V	400/ 380 V	500 V	690/ 660 V	Ident. No. acc. to EN 50011	Version						
Number	A	A	A	A				Order No.	Price per PU			kg

Latched contactor relays with screw terminals · for screw and snap-on mounting onto 35 mm standard mounting rail

3TH27 ..	AC operation				40E 31E 22E	4 3 2	-- 1 2	C C C	3TH27 40-0AP0 3TH27 31-0AP0 3TH27 22-0AP0	1 1 1	1 unit 1 unit 1 unit	101 101 101	0.350 0.350 0.350	
	4	4	3	2										1
	DC operation · DC solenoid system													
	4	4	3	2	1	40E 31E 22E	4 3 2	-- 1 2	C C C	3TH27 40-0BB4 3TH27 31-0BB4 3TH27 22-0BB4	1 1 1	1 unit 1 unit 1 unit	101 101 101	0.400 0.400 0.400

For accessories, see page 3/125.

Rated control supply voltages
(the 10th and 11th position of the order number must be changed)

Rated control supply voltage U_s	Contactor type	3TH20 ..-0...	3TH20 ..-3..., 3TH20 ..-6..., 3TH20 ..-7..., 3TH22, 3TH27

AC operation

Solenoid coils for AC 50 and 60 Hz

50 Hz	60 Hz		
24 V AC	29 V AC	B0	--
110 V AC	132 V AC	F0	--
230/220 V AC	276 V AC	P0 ¹⁾	P0 ¹⁾

DC operation

24 V DC	B4	B4
110 V DC	F4	--
220 V DC	M4	--

¹⁾ Operating range at 220 V or 380 V:
0.85 to 1.15 x U_s ; lower operating range limit according to IEC 60947.

Please inquire about further voltages.

3RT10 coupling relays (interface),
for switching motors, 3-pole, 3 ... 11 kW

Application

DC operation

IEC 60947, EN 60947 (VDE 0660).

The 3RT10 coupling relays for switching motors are tailored to the special requirements of working with electronic controls.

The 3RT10 1 coupling relays cannot be extended with auxiliary switch blocks.

Two single-pole auxiliary switch blocks can be fitted to the 3RT10 2 coupling relays.

Selection and ordering data

DC operation

Low power consumption

Extended operating range of the solenoid coils

Integrated coil circuit

PU (UNIT, SET, M) = 1
PS* = 1 unit
PG = 101



3RT10 1.-1.B4.



3RT10 1.-2.B4.

Surge suppressors	Rated data AC-2 and AC-3, T_U : Up to 60 °C	Auxiliary contacts	DT	Screw terminals		Weight per PU approx.	DT	Cage Clamp terminals		Weight per PU approx.
				Order No.	Price per PU			Order No.	Price per PU	
A	Operational current I_e up to 400 V 400 V	Ident. No. Version NO NC				kg			kg	

For screw and snap-on mounting onto 35 mm standard mounting rail

Size S00

Terminal designations according to EN 50012

Rated control supply voltage $U_s = 24$ V DC, coil operating range **0.7 to 1.25** × U_s

Power consumption of the solenoid coils **2.3 W** at 24 V (no auxiliary switch blocks can be mounted)

Diode, varistor or RC element, attachable	7	3	10	1	--	▶	3RT10 15-1HB41	0.260	B	3RT10 15-2HB41	0.260
			01	--	1	▶	3RT10 15-1HB42	0.260	B	3RT10 15-2HB42	0.260
Built-in diode	7	3	10	1	--	▶	3RT10 15-1JB41	0.260	▶	3RT10 15-2JB41	0.260
			01	--	1	▶	3RT10 15-1JB42	0.260	▶	3RT10 15-2JB42	0.260
Built-in varistor	7	3	10	1	--	▶	3RT10 15-1KB41	0.260	▶	3RT10 15-2KB41	0.260
			01	--	1	▶	3RT10 15-1KB42	0.260	▶	3RT10 15-2KB42	0.260
Diode, varistor or RC element, attachable	9	4	10	1	--	▶	3RT10 16-1HB41	0.260	B	3RT10 16-2HB41	0.260
			01	--	1	▶	3RT10 16-1HB42	0.260	B	3RT10 16-2HB42	0.260
Built-in diode	9	4	10	1	--	▶	3RT10 16-1JB41	0.260	▶	3RT10 16-2JB41	0.260
			01	--	1	▶	3RT10 16-1JB42	0.260	▶	3RT10 16-2JB42	0.260
Built-in varistor	9	4	10	1	--	▶	3RT10 16-1KB41	0.260	▶	3RT10 16-2KB41	0.260
			01	--	1	▶	3RT10 16-1KB42	0.260	▶	3RT10 16-2KB42	0.260
Diode, varistor or RC element, attachable	12	5.5	10	1	--	A	3RT10 17-1HB41	0.260	B	3RT10 17-2HB41	0.260
			01	--	1	B	3RT10 17-1HB42	0.260	B	3RT10 17-2HB42	0.260
Built-in diode	12	5.5	10	1	--	▶	3RT10 17-1JB41	0.260	▶	3RT10 17-2JB41	0.260
			01	--	1	▶	3RT10 17-1JB42	0.260	A	3RT10 17-2JB42	0.260
Built-in varistor	12	5.5	10	1	--	▶	3RT10 17-1KB41	0.260	▶	3RT10 17-2KB41	0.260
			01	--	1	▶	3RT10 17-1KB42	0.260	▶	3RT10 17-2KB42	0.260

For accessories, see page 3/107.

3RT Coupling Relays

**3RT10 coupling relays (interface),
for switching motors, 3-pole, 3 ... 11 kW**

DC operation

Low power consumption

Extended operating range of the solenoid coils

Integrated coil circuit

PU (UNIT, SET, M) = 1
PS* = 1 unit
PG = 101



3RT10 1.-1.B4.



3RT10 1.-2.B4.

Surge suppressors	Rated data AC-2 and AC-3, T_U : Up to 60 °C		Auxiliary contacts		DT	Screw terminals		Weight per PU approx.	DT	Cage Clamp terminals		Weight per PU approx.
	Operational current I_e up to	Rating of induction motors at 50 Hz and	Ident. No.	Version		Order No.	Price per PU			Order No.	Price per PU	
A	400 V	400 V						kg				kg
			NO	NC								

For screw and snap-on mounting onto 35 mm standard mounting rail

Size S00

Terminal designations according to EN 50012

Rated control supply voltage $U_s = 24$ V DC, operating range **0.85 to 1.85 x U_s**

Power consumption of the solenoid coils **1.4 W** at 24 V (no auxiliary switch blocks can be mounted)

Diode, varistor or RC element, attachable	7	3	10 01	1 --	-- 1	B B	3RT10 15-1MB41-0KT0 3RT10 15-1MB42-0KT0	0.260 0.260	B B	3RT10 15-2MB41-0KT0 3RT10 15-2MB42-0KT0	0.260 0.260
Built-in diode	7	3	10 01	1 --	-- 1	B B	3RT10 15-1VB41 3RT10 15-1VB42	0.260 0.260	B B	3RT10 15-2VB41 3RT10 15-2VB42	0.260 0.260
Built-in varistor	7	3	10 01	1 --	-- 1	A B	3RT10 15-1WB41 3RT10 15-1WB42	0.260 0.260	B B	3RT10 15-2WB41 3RT10 15-2WB42	0.260 0.260
Diode, varistor or RC element, attachable	9	4	10 01	1 --	-- 1	B B	3RT10 16-1MB41-0KT0 3RT10 16-1MB42-0KT0	0.260 0.260	B B	3RT10 16-2MB41-0KT0 3RT10 16-2MB42-0KT0	0.260 0.260
Built-in diode	9	4	10 01	1 --	-- 1	B B	3RT10 16-1VB41 3RT10 16-1VB42	0.260 0.260	B B	3RT10 16-2VB41 3RT10 16-2VB42	0.260 0.260
Built-in varistor	9	4	10 01	1 --	-- 1	B B	3RT10 16-1WB41 3RT10 16-1WB42	0.260 0.260	B B	3RT10 16-2WB41 3RT10 16-2WB42	0.260 0.260
Diode, varistor or RC element, attachable	12	5.5	10 01	1 --	-- 1	B B	3RT10 17-1MB41-0KT0 3RT10 17-1MB42-0KT0	0.260 0.260	B B	3RT10 17-2MB41-0KT0 3RT10 17-2MB42-0KT0	0.260 0.260
Built-in diode	12	5.5	10 01	1 --	-- 1	B B	3RT10 17-1VB41 3RT10 17-1VB42	0.260 0.260	B B	3RT10 17-2VB41 3RT10 17-2VB42	0.260 0.260
Built-in varistor	12	5.5	10 01	1 --	-- 1	B B	3RT10 17-1WB41 3RT10 17-1WB42	0.260 0.260	B B	3RT10 17-2WB41 3RT10 17-2WB42	0.260 0.260

For accessories, see page 3/107.

3RT Coupling Relays

3RT10 coupling relays (interface),
for switching motors, 3-pole, 3 ... 11 kW

- DC operation
- Low power consumption
- Extended operating range of the solenoid coils
- Integrated coil circuit



PU (UNIT, SET, M) = 1
PS* = 1 unit
PG = 101



3RT10 2.-1KB40



3RT10 2.-3KB40

Surge suppressors	Rated data AC-2 and AC-3, T_{ij} : Up to 60 °C	Auxiliary contacts	DT	Screw terminals		Weight per PU approx.	DT	Cage Clamp terminals		Weight per PU approx.
				Order No.	Price per PU			Order No.	Price per PU	
A	Operational current I_e up to 400 V 400 V kW	Ident. No. Version   NO NC				kg			kg	

For screw and snap-on mounting onto 35 mm standard mounting rail

Size S0

Rated control supply voltage $U_s = 24$ V DC, coil operating range **0.7 to 1.25 x U_s**
Power consumption of the solenoid coils **4.2 W** at 24 V (**2 single-pole auxiliary switch blocks can be mounted**)

Varistor mounted	12	5.5	--	--	--	▶	3RT10 24-1KB40	0.600	B	3RT10 24-3KB40	0.600
	17	7.5	--	--	--	▶	3RT10 25-1KB40	0.600	▶	3RT10 25-3KB40	0.600
	25	11	--	--	--	▶	3RT10 26-1KB40	0.600	▶	3RT10 26-3KB40	0.600

For accessories, see page 3/101.

3TX7, 3RS18 Coupling Relays

3TX7 Coupling Relays, Narrow Design

Relay couplers

Application

AC and DC operation

EN 60664-1, EN 60947 and EN 50005.



In the coupling links in double-decker design, the connections are arranged on two levels; the units are extremely compact. Connection method: Screw terminals or spring-type terminals. For test purposes, versions are available with manual-0-automatic switches.

The input and output coupling links differ with regard to the positioning of the terminals and the LEDs. For equipment identification purposes, each coupling link has a blank labeling plate.

In accordance with the technical specifications of electronic systems, the coupling links have a lower power consumption.

Selection and ordering data

AC and DC operation · for snap-on mounting onto 35 mm standard mounting rail

Rated control supply voltage U_s at AC 50/60 Hz	Contacts Version		Width	DT	Order No.	Price per PU	PU (UNIT, SET, M)	PS*	PG	Weight per PU approx.
V	NO	CO	mm							kg
3TX7 002 relay coupling links with screw terminals										
Output coupling links					Screw terminals 					
24 AC/DC	1 ¹⁾	--	11.5	▶	3TX7 002-1AB00		1	1 unit	101	0.035
		--		▶	3TX7 002-1AB02		1	1 unit	101	0.035
24 AC/DC 230 AC/DC	--	1	17.5	▶	3TX7 002-1BB00		1	1 unit	101	0.045
				▶	3TX7 002-1BF00		1	1 unit	101	0.045
24 AC/DC	2 ²⁾	--	22.5	▶	3TX7 002-1CB00		1	1 unit	101	0.061
	--	2 ^{1) 2)}		▶	3TX7 002-1FB02		1	1 unit	101	0.061
Input coupling links										
24 AC/DC 110 AC/DC	1	--	11.5	▶	3TX7 002-2AB00		1	1 unit	101	0.035
				▶	3TX7 002-2AE00		1	1 unit	101	0.035
230 AC/DC ²⁾	1	--	11.5	▶	3TX7 002-2AF00		1	1 unit	101	0.035
				▶	3TX7 002-2AF05		1	1 unit	101	0.035
230 AC/DC	--	1 ^{1) 3)}	17.5	▶	3TX7 002-2BF02		1	1 unit	101	0.045
3TX7 003 relay coupling links with spring-type terminals										
Output coupling links					Spring-type terminals 					
24 AC/DC	1	--	11.5	▶	3TX7 003-1AB00		1	1 unit	101	0.035
24 AC/DC	--	1	17.5	▶	3TX7 003-1BB00		1	1 unit	101	0.045
24 AC/DC	2 ²⁾	--	22.5	▶	3TX7 003-1CB00		1	1 unit	101	0.055
Input coupling links										
230 AC/DC	1	--	11.5	A	3TX7 003-2AF00		1	1 unit	101	0.035

Note:



For coil voltages which are not listed, see SITOP power DC Power Supplies, e. g. 6EP1 331-2BA10 and 6EP1 731-2BA00, in "Power Supplies".

- 1) Hard gold-plated contacts.
- 2) The same potential must be applied to the output contacts of the 2 NO/2 CO relays.
- 3) Observe max. permissible cable length, see "Technical specifications".

3TX7, 3RS18 Coupling Relays



3TX7 Coupling Relays, Narrow Design

Relay couplers

Rated control supply voltage U_s at AC 50/60 Hz	Contacts Version	Manual-0-automatic switch for testing purposes	Width	DT	Order No.	Price per PU	PU (UNIT, SET, M)	PS*	PG	Weight per PU approx.
V	 NO  CO		mm							kg
3TX7 004 relay couplers with screw terminals										
Output coupling links						Screw terminals 				
24 AC/DC	--	1	Without	6.2	▶ 3TX7 004-1LB00		1	1 unit	101	0.035
230 AC/DC	--	1	Without	6.2	▶ 3TX7 004-1LF00		1	1 unit	101	0.035
	--	1	Without	12.5 ¹⁾	▶ 3TX7 004-1BF05		1	1 unit	101	0.051
24 AC/DC	--	1 ²⁾	Without	6.2	▶ 3TX7 004-1LB02		1	1 unit	101	0.035
24 AC/DC	1	--	Without	6.2	▶ 3TX7 004-1MB00		1	1 unit	101	0.035
230 AC/DC	1	--	Without	6.2	▶ 3TX7 004-1MF00		1	1 unit	101	0.035
24 AC/DC	--	1	With	12.5	▶ 3TX7 004-1BB10		1	1 unit	101	0.052
Input coupling links										
24 AC/DC	1 ²⁾	--	Without	6.2	▶ 3TX7 004-2MB02		1	1 unit	101	0.035
110 AC/DC	1 ²⁾	--	Without	6.2	▶ 3TX7 004-2ME02		1	1 unit	101	0.035
230 AC/DC	1 ²⁾	--	Without	6.2	▶ 3TX7 004-2MF02		1	1 unit	101	0.035



3TX7 004-1LB00

Rated control supply voltage U_s at AC 50/60 Hz	Contacts Version	Manual-0-automatic switch for testing purposes	Width	DT	Order No.	Price per PU	PU (UNIT, SET, M)	PS*	PG	Weight per PU approx.
V	 NO  CO		mm							kg
3TX7 005 relay couplers with spring-type terminals										
Output coupling links						Spring-type terminals 				
24 AC/DC	--	1	Without	6.2	▶ 3TX7 005-1LB00		1	1 unit	101	0.035
230 AC/DC	--	1	Without	6.2	▶ 3TX7 005-1LF00		1	1 unit	101	0.035
24 AC/DC	--	1 ²⁾	Without	6.2	▶ 3TX7 005-1LB02		1	1 unit	101	0.035
24 AC/DC	1	--	Without	6.2	▶ 3TX7 005-1MB00		1	1 unit	101	0.035
230 AC/DC	1	--	Without	6.2	▶ 3TX7 005-1MF00		1	1 unit	101	0.035
Input coupling links										
24 AC/DC	1 ²⁾	--	Without	6.2	C ▶ 3TX7 005-2MB02		1	1 unit	101	0.035
230 AC/DC	1 ²⁾	--	Without	6.2	B ▶ 3TX7 005-2MF02		1	1 unit	101	0.035



3TX7 005-2MB02

Note:

For replacement products, see 3RS18 coupling links with industrial housing or other 3TX7 0 products.

For coil voltages which are not listed, see SITOP power DC Power Supplies, e. g. 6EP1 331-2BA10 and 6EP1 731-2BA00, in "Power Supplies".

1) For long cables.

2) Hard gold-plated contacts.

Accessories

For coupling link	Version	DT	Order No.	Price per PU	PU (UNIT, SET, M)	PS*	PG	Weight per PU approx.
Type								kg
Connecting combs								
3TX7 004	24 terminals, blue Width 6.2 mm	▶	3TX7 004-8AA00		1	1 unit	101	0.017
Connecting cables								
3TX7 002 and 3TX7 004 with screw terminals	24 terminals with supply, blue	A	3TX7 004-8BA00		1	1 unit	101	0.040
3TX7 003 and 3TX7 005 with spring-type terminals								

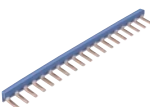

3TX7 004-8AA00



3TX7 004-8BA00

3TX7, 3RS18 Coupling Relays

3TX7 Coupling Relays, Narrow Design

Relay couplers with plug-in connection



Benefits

Advantages

- Plug-in base couplers with spring-type terminals and 6.2 mm width
- Fast exchange with permanent wiring (plug-in relay)
- The wire inlet and terminals can be reached from the front. This results in faster wiring time and wiring errors are prevented.
- Tested complete units → short mounting time
- Single relays available as components
- Linking of supply voltage and control signals with 16-pole connecting comb

- Galvanic isolation plate for isolating different voltages for neighboring units
- Device variants with hard gold-plated contacts, hence high contact reliability
- 24 V DC version also available as variant with NO contact
- Integrated reverse polarity protection and EMC arc-suppression diode
- Clearly visible functional state of the relay coupler by yellow LED
- Protective separation according to EN 50178
- 230 V AC/DC versions available

Selection and ordering data



Rated control supply voltage U_s at AC 50/60 Hz	Contacts Version		DT	Order No.	Price per PU	PU (UNIT, SET, M)	PS*	PG	Weight per PU approx.
V	NO	CO							kg
Plug-in base couplers with screw terminals, 6.2 mm, complete with relay									
					Screw terminals 				
24 DC	1	--	A	3TX7 014-1AM00		1	5 units	101	0.035
24 DC	--	1	A	3TX7 014-1BM00		1	5 units	101	0.035
24 AC/DC	--	1	A	3TX7 014-1BB00		1	5 units	101	0.035
115 AC/DC	--	1	A	3TX7 014-1BE00		1	5 units	101	0.045
230 AC/DC	--	1	A	3TX7 014-1BF00		1	5 units	101	0.041
Plug-in base couplers with screw terminals, 6.2 mm, complete with relay and hard gold-plating¹⁾									
24 DC	--	1	A	3TX7 014-1BM02		1	5 units	101	0.035
24 AC/DC	--	1	A	3TX7 014-1BB02		1	5 units	101	0.035
115 AC/DC	--	1	A	3TX7 014-1BE02		1	5 units	101	0.041
230 AC/DC	--	1	A	3TX7 014-1BF02		1	5 units	101	0.035
Plug-in base couplers with spring-type terminals, 6.2 mm, complete with relay									
					Spring-type terminals 				
24 DC	1	--	A	3TX7 015-1AM00		1	5 units	101	0.045
24 DC	--	1	A	3TX7 015-1BM00		1	5 units	101	0.045
24 AC/DC	--	1	A	3TX7 015-1BB00		1	5 units	101	0.045
115 AC/DC	--	1	A	3TX7 015-1BE00		1	5 units	101	0.045
230 AC/DC	--	1	A	3TX7 015-1BF00		1	5 units	101	0.045
Plug-in base couplers with spring-type terminals, 6.2 mm, complete with relay and hard gold-plating¹⁾									
24 DC	--	1	A	3TX7 015-1BM02		1	5 units	101	0.045
24 AC/DC	--	1	A	3TX7 015-1BB02		1	5 units	101	0.040
115 AC/DC	--	1	A	3TX7 015-1BE02		1	5 units	101	0.045
230 AC/DC	--	1	A	3TX7 015-1BF02		1	5 units	101	0.045

¹⁾ The versions with hard gold-plated contacts feature high contact reliability (also for low currents) and are therefore especially suitable for steady-state inputs of programmable logic controllers.

3TX7, 3RS18 Coupling Relays

3TX7 Coupling Relays, Narrow Design

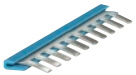
Relay couplers with plug-in connection

Rated control supply voltage U_s at AC 50/60 Hz V	Used for	DT	Order No.	Price per PU	PU (UNIT, SET, M)	PS*	PG	Weight per PU approx. kg
Replacement relay modules¹⁾, 6.2 mm, 1 changeover contact								
12 DC	Complete units 24 V AC/DC	A	3TX7 014-7BQ00		1	20 units	101	0.035
	Complete units 24 V AC/DC, hard gold-plated	A	3TX7 014-7BQ02		1	20 units	101	0.035
24 DC	Complete units 24 V DC	A	3TX7 014-7BM00		1	20 units	101	0.035
	Complete units 24 V DC, hard gold-plating	A	3TX7 014-7BM02		1	20 units	101	0.035
60 DC	Complete units 115 V and 230 V AC/DC	A	3TX7 014-7BP00		1	20 units	101	0.035
	Complete units 115 V and 230 V AC/DC, hard gold-plated	A	3TX7 014-7BP02		1	20 units	101	0.035
Connecting combs 16-pole, blue								
	For linking the same potentials, 16-pole, current carrying capacity for infeed max. 6 A	A	3TX7 014-7AA00		1	5 units	101	0.035
Galvanic isolation plates								
	3TX7014 and 3TX7015	A	3TX7 014-7CE00		1	10 units	101	0.035

3TX7 014-7AA00

3TX7 014-7CE00

¹⁾ The versions with hard gold-plated contacts feature high contact reliability (also for low currents) and are therefore especially suitable for steady-state inputs of programmable logic controllers.

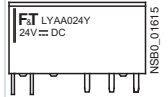
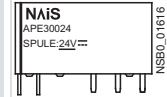
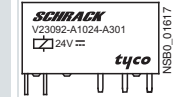
3TX7 014-..	3TX7 015-..	(+)A1/(-)A2	NO (13/14) CO (11/12/14)	3TX7 014-..	 FTR-LY..	 APE..	 V23092-..
..-1AM00 ¹⁾	..-1BM00 ¹⁾	24 V DC	NO	..-7BM00 ¹⁾	..CA024Y	..30024	..A1024-A301
..-1BM00 ¹⁾	..-1BB00 ¹⁾	24 V DC	W	..-7BM00 ¹⁾	..CA024Y	..30024	..A1024-A301
..-1BB00 ¹⁾	..-1BE00 ¹⁾	24 V AC/DC	W	..-7BQ00 ¹⁾	..CA012Y	..30012	..A1012-A301
..-1BE00 ¹⁾	..-1BF00 ¹⁾	115 V AC/DC	W	..-7BP00 ¹⁾	--	..30060	..A1060-A301
..-1BF00 ¹⁾	..-1BM02 ²⁾	230 V AC/DC	W	..-7BP00 ¹⁾	--	..30060	..A1060-A301
..-1BM02 ²⁾	..-1BB02 ²⁾	24 V DC	W	..-7BM02 ²⁾	..CA024V	..30124	..A1024-A201
..-1BB02 ²⁾	..-1BE02 ²⁾	24 V AC/DC	W	..-7BQ02 ²⁾	..CA012V	..30112	..A1012-A201
..-1BE02 ²⁾	..-1BF02 ²⁾	115 V AC/DC	W	..-7BP02 ²⁾	--	..30160	..A1060-A201
..-1BF02 ²⁾		230 V AC/DC	W	..-7BP02 ²⁾	--	..30160	..A1060-A201

¹⁾  = AgSn0

²⁾  = AgSn0+Au

3TX7, 3RS18 Coupling Relays

3TX7 Coupling Relays, Narrow Design

Semiconductor couplers

Overview

AC and DC operation

EN 60664-1, EN 60947 and EN 50005; optocouplers:
EN 60747-5, IEC 61131-2 (programmable logic controllers).

In the coupling links in double-decker design, the connections are arranged on two levels; the units are extremely compact. Connection method: Screw terminals or spring-type terminals. For test purposes, versions are available with manual-0-automatic switches.

The input and output coupling links differ with regard to the positioning of the terminals and the LEDs. For equipment identification purposes, each coupling link has a blank labeling plate.

In accordance with the technical specifications of electronic systems, the coupling links have a lower power consumption.

Selection and ordering data

AC and DC operation · for snap-on mounting onto 35 mm standard mounting rail

Rated control supply voltage U_s at AC 50/60 Hz	Switching voltage	Switching current	Width	DT	Screw terminals		PU (UNIT, SET, M)	PS*	PG	Weight per PU approx.
					Order No.	Price per PU				
V	V	A	mm							kg
3TX7 002 semiconductor couplers with screw terminals, 1 transistor										
Output coupling links										
24 DC	48 ... 264 AC	1.8	12.5	▶	3TX7 002-3AB00		1	1 unit	101	0.033
	< 60 DC	1.5	11.5	▶	3TX7 002-3AB01		1	1 unit	101	0.035
Input coupling links										
24 AC/DC	< 30 DC	0.1	12.5	▶	3TX7 002-4AB00		1	1 unit	101	0.031
110 ... 240 AC	< 30 DC	0.1	12.5	▶	3TX7 002-4AG00		1	1 unit	101	0.035



3TX7 002

Rated control supply voltage U_s at AC 50/60 Hz	Switching voltage	Switching current	Manual-0-automatic switch for testing purposes	Width	DT	Order No.	Price per PU	PU (UNIT, SET, M)	PS*	PG	Weight per PU approx.
V	V	A		mm							kg
3TX7 004 semiconductor couplers with screw terminals											
Output coupling links											
24 DC	≤ 48 DC	0.5	Without	6.2	▶	3TX7 004-3AB04		1	1 unit	101	0.034
24 DC	11 ... 30 DC	1.5			▶	3TX7 004-3PB54		1	1 unit	101	0.029
24 DC	≤ 30 DC	3	Without	6.2	▶	3TX7 004-3PB74		1	1 unit	101	0.032
110 ... 230 AC/DC	≤ 30 DC	3			A	3TX7 004-3PG74		1	1 unit	101	0.033
24 DC	≤ 30 DC	5	Without	12.5	▶	3TX7 004-3AC04		1	1 unit	101	0.052
24 DC	≤ 30 DC	5	With		B	3TX7 004-3AC14		1	1 unit	101	0.061
24 DC	24 ... 250 AC/DC	2	Without	12.5	▶	3TX7 004-3AC03		1	1 unit	101	0.060
Input coupling links											
110 ... 230 AC/DC	≤ 30 DC	0.1	Without	6.2	▶	3TX7 004-4PG24		1	1 unit	101	0.034



3TX7 004-3AB04

Rated control supply voltage U_s at AC 50/60 Hz	Switching voltage	Switching current	Manual-0-automatic switch for testing purposes	Width	DT	Order No.	Price per PU	PU (UNIT, SET, M)	PS*	PG	Weight per PU approx.
V	V	A		mm							kg
3TX7 005 semiconductor couplers with spring-type terminals											
Output coupling links											
24 DC	≤ 48 DC	0.5	Without	6.2	▶	3TX7 005-3AB04		1	1 unit	101	0.031
24 DC	11 ... 30 DC	1.5			▶	3TX7 005-3PB54		1	1 unit	101	0.025
24 DC	≤ 30 DC	3	Without	6.2	A	3TX7 005-3PB74		1	1 unit	101	0.027
110 ... 230 AC/DC	≤ 30 DC	3			A	3TX7 005-3PG74		1	1 unit	101	0.027
24 DC	≤ 30 DC	5	Without	12.5	▶	3TX7 005-3AC04		1	1 unit	101	0.047
24 DC	≤ 30 DC	5	With		C	3TX7 005-3AC14		1	1 unit	101	0.051
24 DC	24 ... 250 AC/DC	2	Without	12.5	C	3TX7 005-3AC03		1	1 unit	101	0.056
Input coupling links											
110 ... 230 AC/DC	≤ 30 DC	0.1	Without	6.2	▶	3TX7 005-4PG24		1	1 unit	101	0.031

Note:



For replacement products, see 3RS18 coupling links with industrial housing or other 3TX7 0 products. For coil voltages which are not listed, see SITOP power DC power supplies, e. g. 6EP1 331-2BA10 and 6EP1 731-2BA00, in "Power Supplies".

3TX7, 3RS18 Coupling Relays

3TX7 Coupling Relays, Narrow Design

Semiconductor couplers

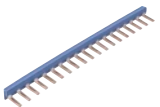
Accessories

For coupling links	Version	DT	Order No.	Price per PU	PU (UNIT, SET, M)	PS*	PG	Weight per PU approx. kg
Connecting combs 24-pole, blue								
Type								
	3TX7 004	▶	3TX7 004-8AA00		1	1 unit	101	0.017
3TX7 004-8AA00	For linking the same potentials, current carrying capacity for infeed max. 26 A							
Connecting cables 24-pole, blue								
	3TX7 002 and 3TX7 004 with screw terminals 3TX7 003 and 3TX7 005 with spring-type terminals	A	3TX7 004-8BA00		1	1 unit	101	0.040
3TX7 004-8BA00	With infeed, current carrying capacity for infeed max. 12 A, length of cable between 2 terminals approx. 11 cm in each case							

* You can order this quantity or a multiple thereof.

3TX7, 3RS18 Coupling Relays

3RS18 Coupling Relays with Industrial Housing

Relay couplers

Overview



The new 3RS18 coupling relays are couplers in the well-proven standard 22.5 mm timing relay enclosure. The series comprises relays with 1, 2 and 3 changeover contacts with screw and spring-type connections for combined voltages and wide voltage ranges.

The relay coils are protected internally with noise suppression diodes.

Benefits

- Wide voltage range: One product for all voltages
- The industrial housing supports the same connection methods as the timing relay including spring-type connections, 2 wires can be clamped
- Versions with solid-state compatible outputs (hard gold-plating)
- Up to 3 changeover contacts with only 22.5 mm width.

Selection and ordering data

Rated control supply voltage U_s at AC 50/60 Hz	Contacts Version	DT	Order No.	Price per PU	PU (UNIT, SET, M)	PS*	PG	Weight per PU approx. kg
V	CO							
Coupling relays with industrial housing 22.5 mm with screw terminals								
Wide voltage range			Screw terminals 					
24 ... 240 AC/DC	2	A	3RS18 00-1BW00		1	1 unit	101	0.143
	3	A	3RS18 00-1HW00		1	1 unit	101	0.168
	3 ¹⁾	A	3RS18 00-1HW01		1	1 unit	101	0.168
Combination voltage								
24 AC/DC and 110 ... 120 AC	1	A	3RS18 00-1AQ00		1	1 unit	101	0.116
	2	A	3RS18 00-1BQ00		1	1 unit	101	0.142
	3	C	3RS18 00-1HQ00		1	1 unit	101	0.173
	3 ¹⁾	C	3RS18 00-1HQ01		1	1 unit	101	0.173
24 AC/DC and 220 ... 240 AC	1	A	3RS18 00-1AP00		1	1 unit	101	0.112
	2	A	3RS18 00-1BP00		1	1 unit	101	0.142
	3	A	3RS18 00-1HP00		1	1 unit	101	0.166
	3 ¹⁾	A	3RS18 00-1HP01		1	1 unit	101	0.170
Coupling relays with industrial housing 22.5 mm with spring-type terminals								
Wide voltage range			Spring-type terminals 					
24 ... 240 AC/DC	2	A	3RS18 00-2BW00		1	1 unit	101	0.128
	3	A	3RS18 00-2HW00		1	1 unit	101	0.144
	3 ¹⁾	C	3RS18 00-2HW01		1	1 unit	101	0.145
Combination voltage								
24 AC/DC and 110 ... 120 AC	1	C	3RS18 00-2AQ00		1	1 unit	101	0.104
	2	C	3RS18 00-2BQ00		1	1 unit	101	0.120
	3	C	3RS18 00-2HQ00		1	1 unit	101	0.147
	3 ¹⁾	C	3RS18 00-2HQ01		1	1 unit	101	0.147
24 AC/DC and 220 ... 240 AC	1	A	3RS18 00-2AP00		1	1 unit	101	0.104
	2	A	3RS18 00-2BP00		1	1 unit	101	0.122
	3	A	3RS18 00-2HP00		1	1 unit	101	0.143
	3 ¹⁾	C	3RS18 00-2HP01		1	1 unit	101	0.147

¹⁾ Hard gold-plated contacts.

Overview

The LZX complete units and accessory parts previously available are no longer listed in this catalog. They can still be supplied however in limited quantities. In their place you will now find the new LZS types. LZS complete units are fully compatible with their predecessors, the LZX complete units. The LZX plug-in relays have not been changed and are used accordingly in both the LZS and the LZX series.

Due to differences in geometry the LED modules, plug-in bases, retaining brackets and labels can be combined and/or used in only the respective series, LZS or LZX.

List for converting from LZX to LZS plug-in relay couplers:

Complete units	
Previous Order No.	New Order No.
LZX:PT3A5L24	LZS:PT3A5L24
LZX:PT3A5R24	LZS:PT3A5R24
LZX:PT3A5S15	LZS:PT3A5S15
LZX:PT3A5T30	LZS:PT3A5T30
LZX:PT5A5L24	LZS:PT5A5L24
LZX:PT5A5R24	LZS:PT5A5R24
LZX:PT5A5S15	LZS:PT5A5S15
LZX:PT5A5T30	LZS:PT5A5T30
LZX:PT5B5L24	LZS:PT5B5L24
LZX:PT5B5R24	LZS:PT5B5R24
LZX:PT5B5S15	LZS:PT5B5S15
LZX:PT5B5T30	LZS:PT5B5T30
LZX:RT3A4L24	LZS:RT3A4L24
LZX:RT3A4R24	LZS:RT3A4R24
LZX:RT3A4S15	LZS:RT3A4S15
LZX:RT3A4T30	LZS:RT3A4T30
LZX:RT3B4L24	LZS:RT3B4L24
LZX:RT3B4R24	LZS:RT3B4R24
LZX:RT3B4S15	LZS:RT3B4S15
LZX:RT3B4T30	LZS:RT3B4T30
LZX:RT4A4L24	LZS:RT4A4L24
LZX:RT4A4R24	LZS:RT4A4R24
LZX:RT4A4S15	LZS:RT4A4S15
LZX:RT4A4T30	LZS:RT4A4T30
LZX:RT4B4L24	LZS:RT4B4L24
LZX:RT4B4R24	LZS:RT4B4R24
LZX:RT4B4S15	LZS:RT4B4S15
LZX:RT4B4T30	LZS:RT4B4T30

Prices for the new LZS series are lower than for the previous LZX series.

Note:

In addition the LZS series offers not only service-proven screw connections but also versions with plug-in terminals.

The following conversion list will help you to change over from the LZX types previously sold to the new LZS types. Please contact your regional adviser if you have any questions.

List for converting from LZX to LZS accessories for individual modules:

Accessories for individual modules	
Previous Order No.	New Order No.
LZX:MT28800	LZS:MT28800
LZX:MT78750	LZS:MT78750
LZX:PT16016	LZS:PT17024¹⁾ LZS:PT17021²⁾
LZX:PT16040	LZS:PT17040
LZX:PT78702	LZS:PT78720
LZX:PT78703	LZS:PT78730
LZX:PT78704	LZS:PT78740
LZX:PT78802	LZS:PT78722
LZX:PT78804	LZS:PT78742
LZX:RPMG0024	LZS:PTMG0024
LZX:RPMG0524	LZS:PTMG0524
LZX:RPMG0730	LZS:PTMG0730
LZX:RPML0024	LZS:PTML0024
LZX:RPML0524	LZS:PTML0524
LZX:RPML0730	LZS:PTML0730
LZX:RPMT00A0	LZS:PTMT00A0
LZX:RPMU0548	LZS:PTMU0524
LZX:RPMU0730	LZS:PTMU0730
LZX:RT16016	LZS:RT17016
LZX:RT78625	LZS:RT78725
LZX:RT78626	LZS:RT78726
LZX:RY16040	LZS:RT17040



¹⁾ LZS:PT17024 for PT standard base without logical isolation: Screw terminals.

²⁾ LZS:PT17021 for PT base with logical isolation: Screw terminals and plug-in terminals.



Coupling Relays with LZS, LZX Plug-In Relays

Plug-in relay couplers

Selection and ordering data

Version	Rated control supply voltage U_s at AC 50/60 Hz	Contacts, number of CO contacts	Width	DT	Order No.	Price per PU	PU (UNIT, SET, M)	PS*	PG	Weight per PU approx.	
	V		mm							kg	
Complete units, 11- and 14-pole, PT series											
Complete units with plug-in base											
For snap-on mounting onto 35 mm standard mounting rail comprising:											
<ul style="list-style-type: none"> • Coupling relays with plug-in relays • Standard plug-in base with screw terminals • LED module (version 24 V DC: LED module with freewheel diode) • Fixing/ejection bracket • Labels 											
Screw terminals 											
 LZS:PT3A5L24	3 CO	24 DC	3	28	A	LZS:PT3A5L24	1	5 units	101	0.085	
		24 AC				LZS:PT3A5R24					
		115 AC				LZS:PT3A5S15					
		230 AC				LZS:PT3A5T30					
	4 CO	24 DC	4	28	A	LZS:PT5A5L24	1	5 units	101	0.090	
		24 AC				LZS:PT5A5R24					
		115 AC				LZS:PT5A5S15					
		230 AC				LZS:PT5A5T30					
	Complete units with plug-in base (logical isolation)¹⁾										
	For snap-on mounting onto 35 mm standard mounting rail comprising:										
	<ul style="list-style-type: none"> • Coupling relays with plug-in relays • Plug-in base with logical isolation and screw terminals • LED module (version 24 V DC: LED module with freewheel diode) • Fixing/ejection bracket • Labels 										
	4 CO	24 DC	4	28	A	LZS:PT5B5L24	1	5 units	101	0.095	
24 AC		LZS:PT5B5R24									
115 AC		LZS:PT5B5S15									
AC 230		LZS:PT5B5T30									

Complete units, 11- and 14-pole, PT series

Complete units with plug-in base (logical isolation)¹⁾										
For snap-on mounting onto 35 mm standard mounting rail comprising:										
<ul style="list-style-type: none"> • Coupling relays with plug-in relays • Plug-in base with logical isolation and plug-in terminals • LED module (version 24 V DC: LED module with freewheel diode) • Fixing/ejection bracket • Labels 										
Plug-in terminals 										
 LZS:PT5D5L24	4 CO	24 DC	4	28	A	LZS:PT5D5L24	1	5 units	101	0.098
		24 AC				LZS:PT5D5R24				
		115 AC				LZS:PT5D5S15				
		230 AC				LZS:PT5D5T30				

¹⁾ **Note:**

Logical isolation: The terminals for the contacts and the terminals for the coil are arranged on separate levels, e. g. above for contacts and below for the coil. Logical isolation is not necessarily protective separation (see the technical specifications of the relay types).







Protective separation: Protective separation prevents voltage of one circuit affecting another circuit with sufficient protection (EN 61140).

Coupling Relays with LZS, LZX Plug-In Relays

Plug-in relay couplers

Version	Rated control supply voltage U_s at AC 50/60 Hz V	Contacts, number of CO contacts	Width mm	DT	Order No.	Price per PU	PU (UNIT, SET, M)	PS*	PG	Weight per PU approx. kg
Individual modules for customer assembly, PT series										
<i>Industrial relays, 8-, 11-, and 14-pole</i>										
 LZX:PT370024	Mini industrial relays									
	• With test bracket and mechanical switch position indicator, without LED ¹⁾									
	24 DC	2	22.5	▶	LZX:PT270024		1	1 unit	101	0.030
		3		▶	LZX:PT370024		1	1 unit	101	0.031
		4		▶	LZX:PT570024		1	1 unit	101	0.031
	24 AC	2	22.5	C	LZX:PT270524		1	1 unit	101	0.030
		3		A	LZX:PT370524		1	1 unit	101	0.031
		4		▶	LZX:PT570524		1	1 unit	101	0.031
	115 AC	2	22.5	C	LZX:PT270615		1	1 unit	101	0.028
		3		A	LZX:PT370615		1	1 unit	101	0.030
		4		▶	LZX:PT570615		1	1 unit	101	0.030
	230 AC	2	22.5	▶	LZX:PT270730		1	1 unit	101	0.029
		3		▶	LZX:PT370730		1	1 unit	101	0.030
		4		▶	LZX:PT570730		1	1 unit	101	0.030
• With hard gold-plating										
24 DC	4	22.5	▶	LZX:PT580024		1	1 unit	101	0.031	
230 AC			▶	LZX:PT580730		1	1 unit	101	0.031	
• Without test bracket										
24 DC	4	22.5	C	LZX:PT520024		1	1 unit	101	0.031	
230 AC			C	LZX:PT520730		1	1 unit	101	0.031	

Plug-in bases for PT relays

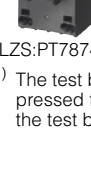
 LZS:PT78720	Standard plug-in bases with screw terminals				Screw terminals 						
	For mounting onto standard mounting rail										
	--	2	28	▶	LZS:PT78720		1	1 unit	101	0.045	
		3		▶	LZS:PT78730		1	1 unit	101	0.048	
	4		▶	LZS:PT78740		1	1 unit	101	0.050		
 LZS:PT78720	Plug-in bases with logical isolation²⁾ and screw terminals										
	For mounting onto standard mounting rail										
	--	2	28	▶	LZS:PT78722		1	1 unit	101	0.048	
	4		▶	LZS:PT78742		1	1 unit	101	0.050		
 LZS:PT78740	Plug-in bases with logical isolation²⁾ with plug-in terminals				Plug-in terminals 						
	For mounting onto standard mounting rail										
	--	2	28	▶	LZS:PT7872P		1	1 unit	101	0.045	
	4		▶	LZS:PT7874P		1	1 unit	101	0.050		
 LZS:PT78722											
 LZS:PT7874P											

¹⁾ The test bracket is designed to be non-latching. If the test bracket is pressed further until 90° has been reached, two small lugs break off and the test bracket can be latched in position.

²⁾ **Note:**
Logical isolation: The terminals for the contacts and the terminals for the coil are arranged on separate levels, e. g. above for contacts and below for coil. Logical isolation is not necessarily protective separation (see the technical specifications of the relay types).
Protective separation: Protective separation prevents voltage of one circuit affecting another circuit with sufficient protection (EN 61140).

Coupling Relays with LZS, LZX Plug-In Relays

Plug-in relay couplers

Version	Rated control supply voltage U_s at AC 50/60 Hz	Contacts, number of CO contacts	Width	DT	Order No.	Price per PU	PU (UNIT, SET, M)	PS*	PG	Weight per PU approx.
	V		mm							kg
Individual modules for customer assembly, PT series										
<i>More individual modules</i>										
LED modules										
• Red										
 LZS:PTML0024	With freewheel diode	24 DC	--	12.5	▶ LZS:PTML0024		1	1 unit	101	0.004
	Without freewheel diode	24 AC/DC			▶ LZS:PTML0524		1	1 unit	101	0.004
		110 ... 230 AC/DC			▶ LZS:PTML0730		1	1 unit	101	0.004
• Green										
 LZS:PTMG0024	With freewheel diode	24 DC	--	12.5	▶ LZS:PTMG0024		1	1 unit	101	0.004
	Without freewheel diode	24 AC			▶ LZS:PTMG0524		1	1 unit	101	0.004
		110 ... 230 AC/DC			▶ LZS:PTMG0730		1	1 unit	101	0.004
Fixing/ejection brackets for PT base with logical isolation¹⁾										
 LZS:PT17021	Screw terminals and plug-in terminals		--	26	▶ LZS:PT17021		100	10 units	101	0.300
	Fixing/ejection brackets for standard plug-in base without logical isolation									
 LZS:PT17024	Screw terminals		--	26	▶ LZS:PT17024		100	10 units	101	0.300
	Labels									
 LZS:PT17040			--	26	▶ LZS:PT17040		100	10 units	101	0.200
	RC element									
 LZS:PTMU0730		6 ... 60 AC	--	26	▶ LZS:PTMU0524		1	1 unit	101	0.004
		110 ... 230 AC			▶ LZS:PTMU0730		1	1 unit	101	0.004
Freewheel diodes with connection to A1										
 LZS:PTMT00A0		6 ... 230 DC	--	26	▶ LZS:PTMT00A0		1	1 unit	101	0.004
	Connecting cables									
 LZS:PTMU0730	24-pole, current carrying capacity 12 A, with supply, blue			A	▶ 3TX7 004-8BA00		1	1 unit	101	0.040
	Connecting combs for PT screw base									
 3TX7 004-8BA00	6-pole, 10 A current carrying capacity, natural-colored				▶ LZS:PT170R6		1	10 units	101	0.002
	Connecting brackets for PT push-in base									
 3TX7 004-8BA00	2-pole, 10 A current carrying capacity, natural-colored				▶ LZS:PT170P1		1	10 units	101	0.002
	Individual modules for customer assembly, MT series									
<i>Industrial relays, 11-pole</i>										
Industrial relays with test bracket										
 LZX:MT326024	Without LED	24 DC	3	35.5	A ▶ LZX:MT321024		1	1 unit	101	0.088
	With LED				▶ LZX:MT323024		1	1 unit	101	0.088
 LZX:MT326024	Without LED	24 AC	3	35.5	A ▶ LZX:MT326024		1	1 unit	101	0.089
	With LED				C ▶ LZX:MT328024		1	1 unit	101	0.089
 LZX:MT326024	Without LED	115 AC	3	35.5	C ▶ LZX:MT326115		1	1 unit	101	0.087
	With LED				C ▶ LZX:MT328115		1	1 unit	101	0.088
 LZX:MT326024	Without LED	230 AC	3	35.5	A ▶ LZX:MT326230		1	1 unit	101	0.089
	With LED				A ▶ LZX:MT328230		1	1 unit	101	0.089
Plug-in bases for mounting onto standard mounting rail										
 LZS:MT78750	For mounting onto standard mounting rail				Screw terminals 					
	With screw terminals		--	38	▶ LZS:MT78750		1	1 unit	101	0.050
Retaining brackets										
 LZS:MT28800			--	38	▶ LZS:MT28800		1	1 unit	101	0.003

Note:



For coil voltages which are not listed, see SITOP power DC Power Supplies, e. g. 6EP1 331-2AB10 and 6EP1 731-2AB00, in "Power Supplies".

¹⁾ Note:

Logical isolation: The terminals for the contacts and the terminals for the coil are arranged on separate levels, e. g. above for contacts and below for coil. Logical isolation is not necessarily protective separation (see the technical specifications of the relay types).
Protective separation: Protective separation prevents voltage of one circuit affecting another circuit with sufficient protection (EN 61140).

Coupling Relays with LZS, LZX Plug-In Relays

Plug-in relay couplers

Version	Rated control supply voltage U_s at AC 50/60 Hz	Contacts, number of CO contacts	Width	DT	Order No.	Price per PU	PU (UNIT, SET, M)	PS*	PG	Weight per PU approx.
	V		mm							kg
Complete units, 8-pole, 5 mm pinning, RT series										
Complete units with standard plug-in base					Screw terminals 					
For snap-on mounting onto 35 mm standard mounting rail comprising:										
<ul style="list-style-type: none"> • Coupling relays with plug-in relays • Standard plug-in base with screw terminals • LED module (version 24 V DC: LED module with freewheel diode) • Fixing/ejection bracket • Labels 										
1 CO	24 DC	1	15.5	A	LZS:RT3A4L24		1	5 units	101	0.052
	24 AC			A	LZS:RT3A4R24		1	5 units	101	0.052
	115 AC			A	LZS:RT3A4S15		1	5 units	101	0.052
	230 AC			A	LZS:RT3A4T30		1	5 units	101	0.052
2 CO	24 DC	2	15.5	A	LZS:RT4A4L24		1	5 units	101	0.052
	24 AC			A	LZS:RT4A4R24		1	5 units	101	0.052
	115 AC			A	LZS:RT4A4S15		1	5 units	101	0.052
	230 AC			A	LZS:RT4A4T30		1	5 units	101	0.052
Complete units with plug-in base with logical isolation and screw terminals										
For snap-on mounting onto 35 mm standard mounting rail comprising:										
<ul style="list-style-type: none"> • Coupling relays with plug-in relays • Plug-in base with logical isolation and screw terminals • LED module (version 24 V DC: LED module with freewheel diode) • Fixing/ejection bracket • Labels 										
1 CO	24 DC	1	15.5	A	LZS:RT3B4L24		1	5 units	101	0.055
	24 AC			A	LZS:RT3B4R24		1	5 units	101	0.055
	115 AC			A	LZS:RT3B4S15		1	5 units	101	0.055
	230 AC			A	LZS:RT3B4T30		1	5 units	101	0.055
2 CO	24 DC	2	15.5	A	LZS:RT4B4L24		1	5 units	101	0.055
	24 AC			A	LZS:RT4B4R24		1	5 units	101	0.055
	115 AC			A	LZS:RT4B4S15		1	5 units	101	0.055
	230 AC			A	LZS:RT4B4T30		1	5 units	101	0.055
Complete units, 8-pole, 5 mm pinning, RT series										
Complete units with plug-in base with logical isolation and plug-in terminals					Plug-in terminals 					
For snap-on mounting onto 35 mm standard mounting rail comprising:										
<ul style="list-style-type: none"> • Coupling relays with plug-in relays • Plug-in base with logical isolation and plug-in terminals • LED module (version 24 V DC: LED module with freewheel diode) • Fixing/ejection bracket • Labels 										
1 CO	24 DC	1	15.5	A	LZS:RT3D4L24		1	5 units	101	0.065
	24 AC			A	LZS:RT3D4R24		1	5 units	101	0.065
	115 AC			A	LZS:RT3D4S15		1	5 units	101	0.065
	230 AC			A	LZS:RT3D4T30		1	5 units	101	0.065
2 CO	24 DC	2	15.5	A	LZS:RT4D4L24		1	5 units	101	0.065
	24 AC			A	LZS:RT4D4R24		1	5 units	101	0.065
	115 AC			A	LZS:RT4D4S15		1	5 units	101	0.065
	230 AC			A	LZS:RT4D4T30		1	5 units	101	0.065



LZS:RT4B4T30



LZS:RT3D4L24

Note:

Logical isolation: The terminals for the contacts and the terminals for the coil are arranged on separate levels, e. g. above for contacts and below for the coil. Logical isolation is not necessarily protective separation (see the technical specifications of the relay types). Protective separation: Protective separation prevents voltage of one circuit affecting another circuit with sufficient protection (EN 61140).

Coupling Relays with LZS, LZX Plug-In Relays

Plug-in relay couplers

Version	Rated control supply voltage U_s at AC 50/60 Hz	Contacts, number of CO contacts	Width	DT	Order No.	Price per PU	PU (UNIT, SET, M)	PS*	PG	Weight per PU approx.	
	V		mm							kg	
Individual modules for customer assembly, RT series											
<i>Print relays, 8-pole, 5 mm pinning</i>											
	Print relays • With hard gold-plating Version with 1 CO contact										
	24 DC	1	12.7	C	LZX:RT315024		1	1 unit	101	0.016	
	230 AC			C	LZX:RT315730		1	1 unit	101	0.015	
LZX:RT314024	Print relays Version with 1 CO contact										
	24 DC	1	12.7	▶ C	LZX:RT314024		1	1 unit	101	0.016	
	24 AC			C	LZX:RT314524		1	1 unit	101	0.007	
	115 AC			C	LZX:RT314615		1	1 unit	101	0.013	
	230 AC			▶ C	LZX:RT314730		1	1 unit	101	0.007	
	Version with 2 CO contacts										
	12 DC	2	12.7	C	LZX:RT424012		1	1 unit	101	0.015	
	24 DC			▶ C	LZX:RT424024		1	1 unit	101	0.015	
	24 AC			▶ C	LZX:RT424524		1	1 unit	101	0.014	
	115 AC			▶ C	LZX:RT424615		1	1 unit	101	0.012	
	230 AC			▶ C	LZX:RT424730		1	1 unit	101	0.010	
LZS:RT78725	Standard plug-in bases with screw terminals										
					Screw terminals						
	For mounting onto standard mounting rail --			15.5	▶	LZS:RT78725		1	1 unit	101	0.035
	Plug-in bases with logical isolation and screw terminals										
	For mounting onto standard mounting rail --			15.5	▶	LZS:RT78726		1	1 unit	101	0.037
	Plug-in bases with logical isolation and plug-in terminals										
					Plug-in terminals						
	For mounting onto standard mounting rail --			15.5	▶	LZS:RT7872P		1	1 unit	101	0.035
LZS:RT78726	LED modules										
	• Red										
	With freewheel diode	24 DC	--	15.5	▶	LZS:PTML0024		1	1 unit	101	0.004
	Without freewheel diode	24 AC/DC	--		▶	LZS:PTML0524		1	1 unit	101	0.004
		110 ... 230 AC/DC	--		▶	LZS:PTML0730		1	1 unit	101	0.004
	• Green										
	With freewheel diode	24 DC	--	15.5	▶	LZS:PTMG0024		1	1 unit	101	0.004
	Without freewheel diode	24 AC/DC	--		▶	LZS:PTMG0524		1	1 unit	101	0.004
		110 ... 230 AC/DC	--		▶	LZS:PTMG0730		1	1 unit	101	0.004
LZS:RT7872P	Fixing/ejection brackets										
	For RT bases										
	--	--	15.5	▶	LZS:RT17016		100	10 units	101	0.300	
LZS:RT17016	Labels										
	--	--	15.5	▶	LZS:RT17040		100	10 units	101	0.200	
LZS:RT17040	RC elements										
	6 ... 60 AC	--	15.5	▶	LZS:PTMU0524		1	1 unit	101	0.004	
	110 ... 230 AC			▶	LZS:PTMU0730		1	1 unit	101	0.004	
	Freewheel diodes with connection to A1										
	6 ... 230 DC	--	15.5	▶	LZS:PTMT00A0		1	1 unit	101	0.004	
LZS:PTMT0730	Connecting cables										
	24-pole, current carrying capacity 12 A, with supply, blue				A	3TX7 004-8BA00		1	1 unit	101	0.040
	Connecting combs for RT screw base										
	8-pole, 10 A current carrying capacity, natural-colored				▶	LZS:RT170R8		1	10 units	101	0.002
	Connecting brackets for PT push-in base										
	2-pole, 10 A current carrying capacity, natural-colored				▶	LZS:RT170P1		1	10 units	101	0.002
3TX7 004-8BA00											

Note: For coil voltages which are not listed, see SITOP power DC power supplies, e. g. 6EP1 331-2BA10 and 6EP1 731-2BA00, in "Power Supplies".

* You can order this quantity or a multiple thereof.

Plug-in relay couplers

More information

Notes on configuration

PT series

Mounting the LZS:PT17024 fixing/ejection bracket on the LZS:PT787.0 standard plug-in base with screw terminals:

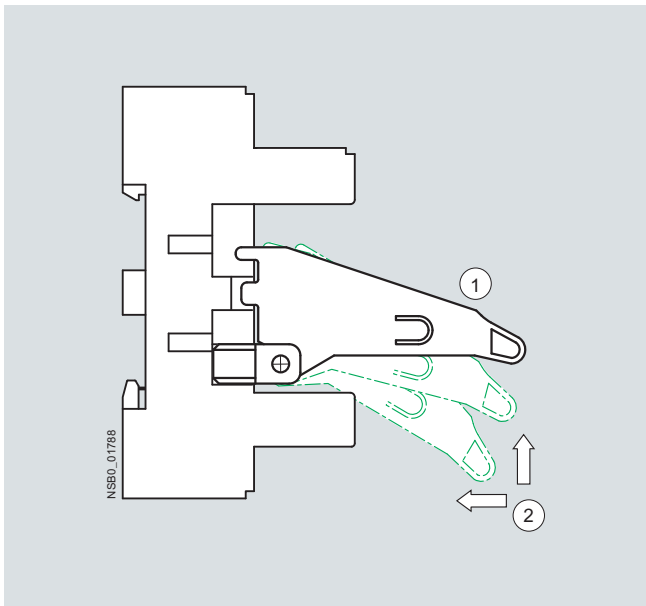

Legend:

- ① Locking position
- ② Mounting direction

RT series

Mounting the LZS:RT17016 fixing/ejection bracket on the LZS:RT7872 plug-in base.

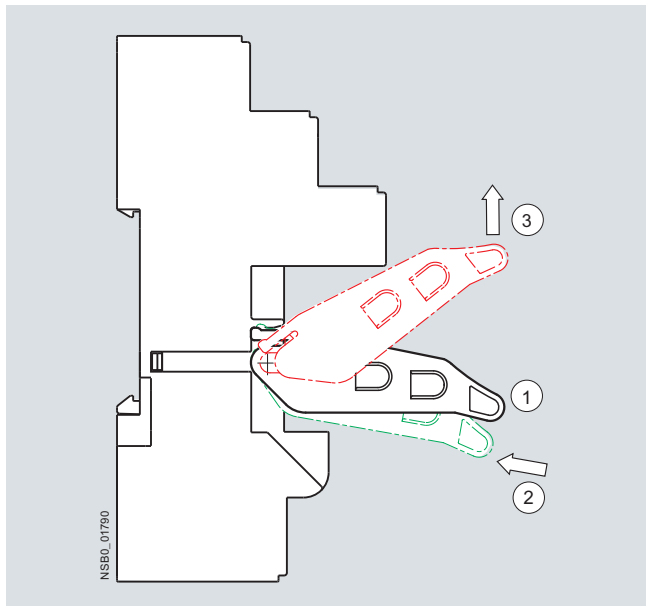

Legend:

- ① Locking position
- ② Mounting direction
- ③ Demounting direction

Mounting the coupling relay with plug-in relay

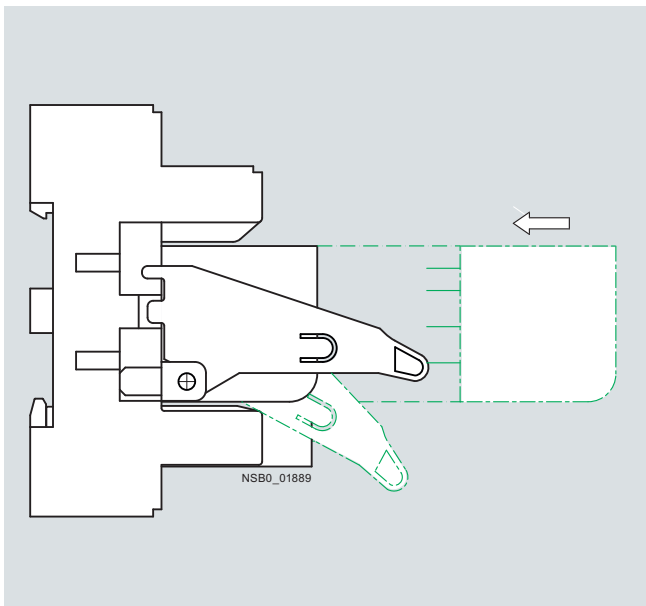

Important:

The LZS:PT17021 and LZS:PT17024 ejection brackets of the coupling relays with plug-in relay are not status displays!

Mounting the coupling relay with plug-in relay

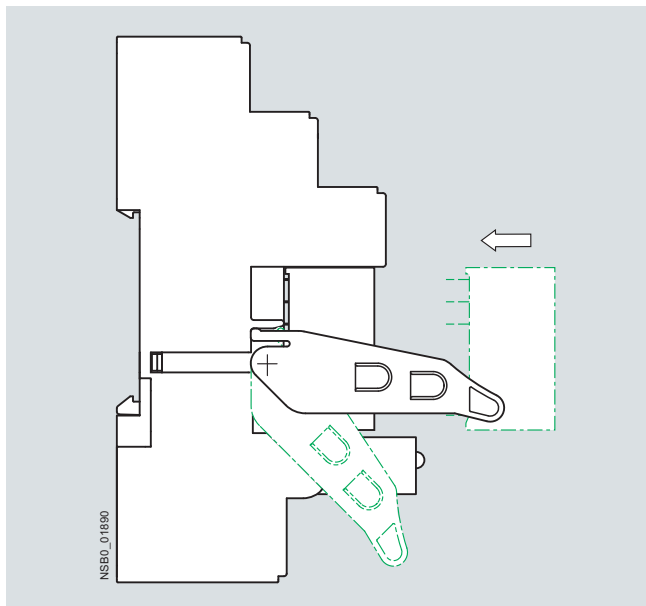

Important:

The LZS:RT17016 ejection brackets of the coupling relays with plug-in relay are not status displays!

3

3TG10 Power Relays/Miniature Contactors

4-pole, 4 kW

Overview

Version

The 3TG10 power relays/miniature contactors with 4 main contacts are available with 6.3 mm × 0.8 mm screw terminals or flat connectors. The versions with screw terminals are climate-proof and finger-safe according to EN 61140.

The 3TG10 power relays/miniature contactors are small. Their width is 36 mm.

Application

Because they are hum-free they are suitable for use in household appliances and distribution boards in office and residential areas. They can also be used for applications where there is little space such as air conditioners, heating systems, pumps and fans, i.e. for simple electrical controls.

AC and DC operation

EN 60947-4-1

Surge suppression

The 3TG10 power relays/miniature contactors have an integrated protective circuit against opening surges.

Overload and short-circuit protection

The 3UA7 overload relay can be used for overload protection. This applies to mounting onto contactors and to stand-alone installation.

Information about short-circuit protection by means of contactors can be found in the "Technical specifications".

Selection and ordering data

Rated data		Utilization category		Main contacts		Rated control supply voltage U_s	DT	Order No.	Price per PU	PU (UNIT, SET, M)	PS*	PG	Weight per PU approx.
Operational current I_e up to 400 V	Power of AC loads at 50 Hz and 400 V	Operational current I_e up to 400 V ¹⁾	Power of AC loads at 50 Hz and 400 V	NO	NC	Version							kg
A	kW	A	kW										

With screw terminals, 4-pole For screw and snap-on mounting onto 35 mm standard mounting rail Hum-free

AC operation, 45 ... 450 Hz								Screw terminals								
	20	13	8.4	4	4	--	24 AC	▶	3TG10 10-0AC2	1	1 unit	101	0.157			
								▶	3TG10 10-0AG2	1	1 unit	101	0.158			
								▶	3TG10 10-0AL2	1	1 unit	101	0.156			
								3	1	24 AC	▶	3TG10 01-0AC2	1	1 unit	101	0.157
											▶	3TG10 01-0AG2	1	1 unit	101	0.158
											▶	3TG10 01-0AL2	1	1 unit	101	0.157
DC operation																
3TG10 ...-0...	20	13	8.4	4	4	--	24 DC	▶	3TG10 10-0BB4	1	1 unit	101	0.157			
								▶	3TG10 01-0BB4	1	1 unit	101	0.157			

With 6.3 × 0.8 mm flat connectors, 4-pole For screw and snap-on mounting onto 35 mm standard mounting rail Hum-free

AC operation, 45 ... 450 Hz								Flat connectors								
	16	10	8.4	4	4	--	24 AC	▶	3TG10 10-1AC2	1	1 unit	101	0.146			
								D	3TG10 10-1AG2	1	1 unit	101	0.146			
								▶	3TG10 10-1AL2	1	1 unit	101	0.145			
								3	1	24 AC	D	3TG10 01-1AC2	1	1 unit	101	0.147
											D	3TG10 01-1AG2	1	1 unit	101	0.146
											▶	3TG10 01-1AL2	1	1 unit	101	0.144
DC operation																
3TG10 ...-1...	16	10	8.4	4	4	--	24 DC	▶	3TG10 10-1BB4	1	1 unit	101	0.146			
								D	3TG10 01-1BB4	1	1 unit	101	0.146			

For accessories see page 3/123.

Accessories and Spare Parts

For 3RT, 3RH Contactors and Contactor Relays

Accessories for 3RT, 3RH contactors
and contactor relays

Overview

Snap-on auxiliary switch blocks

The auxiliary switch blocks and the maximum number of blocks that can be mounted are described in the sections "Motor Contactors" and "Contactor Relays".

Solid-state time-delay auxiliary switch block

The timer module, which is available in the "ON-DELAY" and "OFF-DELAY" versions, allows time-delayed functions up to 100 s (3 distinct delay ranges).

It contains a relay with one NO contact and one NC contact; depending on the version, the relay is switched either after an ON-delay or after an OFF-delay.

The timer module with "WYE-DELTA FUNCTION" is equipped with one delayed and one instantaneous NO contact, with a dead time of 50 ms between the two. The delay time of the NO contact can be adjusted between 1.5 s and 30 s.

Wye-delta function:

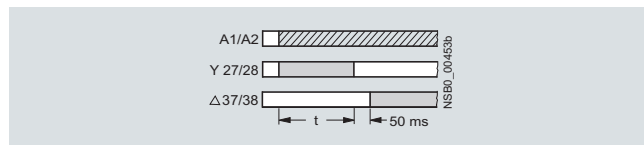

The contactor on which the solid-state, time-delay auxiliary switch block is mounted operates without a delay.

Size S00

The solid-state, time-delay auxiliary switch block is fitted onto the front side of the contactor. The timer module is supplied with power directly by plug-in contacts through the coil terminals of the contactor, in parallel with A1/A2. The timing function is activated by closing the contactor on which the auxiliary switch block is mounted. The OFF-delay version operates without an auxiliary voltage; minimum ON period: 200 ms.

A varistor is integrated in the timer module in order to damp opening surges in the contactor coil.

The solid-state, time-delay auxiliary switch block cannot be mounted on size S00 coupling relays.

Sizes S0 to S12

The solid-state, time-delay auxiliary switch block is fitted onto the front side of the contactor.

The timer module is supplied with power through two terminals (A1/A2); the time delay of the auxiliary switch block can be activated either by a parallel link to any contactor coil or by any power source.

The OFF-delay version operates without an auxiliary voltage; minimum ON period: 200 ms.

A single-pole auxiliary switch block can be snapped onto the front of the contactor in addition to the timer module.

The timer module has no integrated components for overvoltage damping.

Solid-state time-delay block with semiconductor output

The timer module in the "ON-DELAY" and "OFF-DELAY with auxiliary voltage" versions allows time-delayed functions up to 100 s (3 distinct delay ranges). Contactors fitted with a time-delay block close or open after a delay according to the set time.

The ON-delay variant of the timing relay is connected in series with the contactor coil; terminal A1 of this coil must not be connected.

With the OFF-delay variant of the timing relay, the contactor coil is contacted directly through the relay; terminals A1 and A2 of the contactor coil must not be connected.

The timing relays are suitable for both AC and DC operation.

Size S00

The version for size S00 contactors is fitted onto the front of the contactor (with the supply voltage switched off) and then slid into its latched position; at the same time, the timing relay is connected by means of plug-in contacts to coil terminals A1 and A2 of the contactor. Any contactor coil terminals which are not required are sealed off by means of covers on the enclosure of the time-delay block, to prevent them from being connected inadvertently.

A varistor is integrated in the timer module in order to damp opening surges in the contactor coil.

The solid-state, time-delay block cannot be mounted on size S00 coupling relays.

Sizes S0 to S3

The time-delay block for size S0 to S3 contactors is plugged into coil terminals A1 and A2 on top of each contactor; the timing relay is connected both electrically and mechanically by means of pins.

A varistor is integrated in the timer module in order to damp opening surges in the contactor coil.

Configuring note:

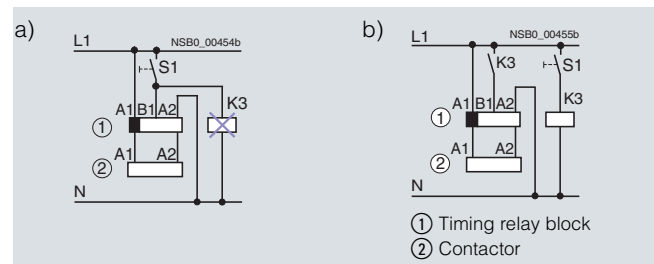

The activation of loads parallel to the start input is not permissible when using AC control voltage (see (a) in the circuit diagram).

The 3RT19 16-2D... / 3RT19 26-2D... OFF-delay timing relay blocks have a zero potential start input B1. This means that if there is a parallel load on terminal B1, activation can be simulated with AC voltage. In this case, the additional load (e. g. contactor K3) must be wired according to (b).

OFF-delay device for size S00 to S3 contactors

AC and DC operation

IEC 60947, EN 60947.

For screw and snap-on mounting onto 35 mm standard mounting rail. The OFF-delay devices have screw terminals.

The OFF-delay device prevents a contactor from dropping out unintentionally when there is a short-time voltage dip or voltage failure. It supplies a downstream, DC-operated contactor with the necessary energy during a voltage dip, ensuring that the contactor does not trip. The 3RT19 16 OFF-delay devices are specifically designed for operation with the 3RT contactors and 3RH contactor relays of the SIRIUS series.

The OFF-delay device operates without external voltage on a capacitive basis, and can be energized with either AC or DC (24 V version only for DC operation). Voltage matching, which is only necessary with AC operation, is performed using a rectifier bridge.

Accessories and Spare Parts

For 3RT, 3RH Contactors and Contactor Relays

Accessories for 3RT, 3RH contactors and contactor relays

A contactor opens after a delay when the capacitors of the solenoid coil, built into the OFF-delay device, are switched in parallel. In the event of voltage failures, the capacitors are discharged via the solenoid coil and thereby delay the opening of the contactor.

If the command devices are upstream of the OFF-delay device in the circuit, the OFF-delay takes effect with every opening operation. If the opening operation is downstream of the OFF-delay device, an OFF-delay only applies in the event of failure of the mains voltage.

Operation

In the case of the versions for rated control supply voltages of 110 V and 230 V, either AC voltage or DC voltage can be applied on the line side, whereas the variant for 24 V is designed for DC operation only.

A DC-operated contactor is connected to the output in accordance with the input voltage that is applied.

The mean value of the OFF-delay is approximately 1.5 times the specified minimum time.

Surge suppressors

- Without LED (also for Cage Clamp terminals) size S00, S0, S2, S3, S6 to S12
- With LED (also for Cage Clamp terminals) size S00

All 3RT1 contactors and 3RH1 contactor relays can be retrofitted with RC elements or varistors for damping opening surges in the coil. Diodes or diode assemblies (comprising noise suppression diodes and Zener diodes for rapid switch-off) can be used.

The surge suppressors are plugged onto the front of size S00 contactors. Space is provided for them next to a snap-on auxiliary switch block.

With all size S0 to S3 contactors, varistors, RC elements and diode assemblies can be plugged on directly at the coil terminals, either on the top or underneath.

The plug-in direction of the diodes and diode assemblies is determined by a coding device.

Coupling relays are supplied either without surge suppression or with a varistor or diode connected as standard, according to the version.

Note:

The OFF-delay times of the NO contacts and the ON-delay times of the NC contacts increase if the contactor coils are damped against voltage peaks (noise suppression diode 6 to 10 times; diode assemblies 2 to 6 times, varistor +2 to 5 ms).

Electromagnetic interference suppression module, 3-phase for size S00 contactors



A so-called counter-e.m.f. (electromotive force) is produced when motors or various inductive loads are turned off. Voltage peaks of up to 4000 V may occur as a result, with a frequency spectrum from 1 kHz to 10 MHz and a rate of voltage variation from 0.1 to 20 V/ns.

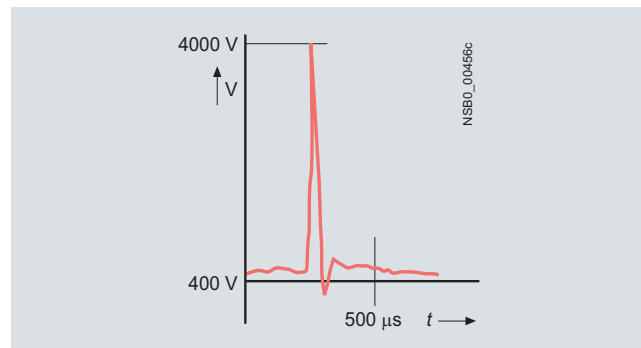

Capacitive input to various analog and digital signals makes it necessary to suppress interference in the load circuit.

Reducing contact arcing

The connection between the main current path and the EMC suppression module enables contact arcing, which is responsible for contact erosion and the majority of clicking noises, to be reduced; this in turn is conducive to an electromagnetically compatible design.

Higher operational reliability

Since the EMC suppression module achieves a significant reduction in radio-frequency components and the voltage level in three phases, the contact endurance is also improved considerably. This makes an important contribution towards enhancing the reliability and availability of the system as a whole.

Accessories and Spare Parts

For 3RT, 3RH Contactors and Contactor Relays

Accessories for 3RT, 3RH contactors and contactor relays

Dispensing with fine graduations

There is no need for fine graduations within each performance class, as smaller motors inherently have a higher inductance, so that one solution for all fixed-speed operating mechanisms up to 5.5 kW is adequate.

Two electrical versions are available:

- The advantages of the RC circuit lie mainly in the reduction in the rate of rise and in its RF damping ability. The selected values ensure effective interference suppression over a wide range.

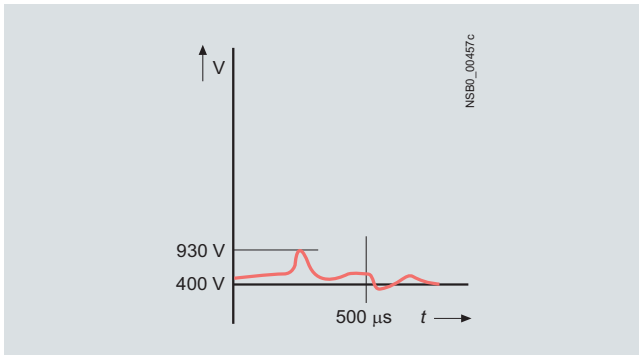

- The varistor circuit can absorb a high energy level and can also be used for frequencies ranging from 10 to 400 Hz (closed-loop controlled operating mechanisms). There is no limiting below the knee-point voltage, however.

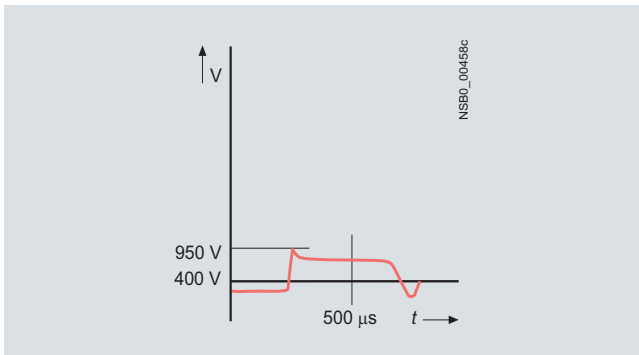

Additional load module

- Size S00 for plugging onto the front of the contactors with and without auxiliary switch block

Coupling links for mounting on contactors of sizes S0 to S3

DC operation

IEC 60947 and EN 60947.

The coupling link is suitable for use in any climate. It is finger-safe according to EN 50274. The terminal designations comply with EN 50005.

System-compatible operation with 24 V DC, operating range 17 to 30 V.

Low power consumption in conformity with the technical specifications of the solid-state systems. An LED indicates the switching state.

Surge suppression

The 3RH19 24-1GP11 coupling link has an integrated surge suppressor (varistor) for the contactor coil being switched.

Mounting

The 3RH19 24-1GP11 coupling link is mounted directly on the contactor coil.

Solder pin adapters

The solder pin adapters for the size S00 contactors are available in two versions:

- Solder pin adapter for contactors with one integrated auxiliary contact
- Solder pin adapter for contactors with mounted 4-pole auxiliary switch block

Screw adapters

Plug-on adapters improve the accessibility of the screw fixing for size S0 contactors. As a result it is possible to position the screwdriver vertically even when using insulated screwdrivers or power screwdrivers.

Optionally the adapters can be rotated through 90° before mounting.

Sealable covers for sizes S00 to S12

When contactors and contactor relays are used in safety-oriented applications, it must be ensured that it is impossible to operate the contactors manually.

For SIRIUS contactors there are sealable covers available for this purpose as accessories; these prevent accidental manual operation. These are transparent molded-plastic caps with a bracket that enables the contactor to be sealed.

Accessories and Spare Parts

For 3RT, 3RH Contactors and Contactor Relays

Accessories for 3RT, 3RH contactors and contactor relays

Selection and ordering data

PU (UNIT, SET, M) = 1
 PS* = 1 unit
 PG = 101



3RH19 11-1HA..
3RH19 11-1FA..



3RH19 11-2HA..



3RH19 21-1HA..

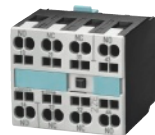

3RH19 21-2HA..
3RH19 21-2FA..



3RH19 11-1AA..



3RH19 11-1LA..

For contactors	Auxiliary contacts	DT	Screw terminals	Weight per PU approx.	DT	Cage Clamp terminals	Weight per PU approx.
	Ident. No.	Version	Order No.	Price per PU		Order No.	Price per PU
Type	 NO NC NO NC			kg			kg

Auxiliary switch blocks for snapping onto the front according to EN 50012

Size S00

For assembling contactors with 2, 4 or 5 auxiliary contacts

3RT10 1.-1...1, 3RT10 1.-2...1 Ident. No. 10 E	11 E	-- 1 -- --	▶	3RH19 11-1HA01	0.060	▶	3RH19 11-2HA01	0.060
	22 E	1 2 -- --	▶	3RH19 11-1HA12	0.060	▶	3RH19 11-2HA12	0.060
	23 E	1 3 -- --	▶	3RH19 11-1HA13	0.060	▶	3RH19 11-2HA13	0.060
	32 E	2 2 -- --	▶	3RH19 11-1HA22	0.060	▶	3RH19 11-2HA22	0.060

Sizes S0 ... S12¹⁾

4-pole

3RT10 2, 3RT1. 3... 3RT1. 7	31	3 1 -- --	▶	3RH19 21-1HA31	0.075	▶	3RH19 21-2HA31	0.075
	22	2 2 -- --	▶	3RH19 21-1HA22	0.075	▶	3RH19 21-2HA22	0.075
	13	1 3 -- --	▶	3RH19 21-1HA13	0.075	▶	3RH19 21-2HA13	0.075
	22²⁾	2 2 -- --	▶	3RH19 21-1XA22-0MA0	0.075	D	3RH19 21-2XA22-0MA0	0.075

Auxiliary switch blocks for snapping onto the front according to EN 50005

Size S00

2 or 4-pole auxiliary switch blocks for assembling contactors with 3 or 5 auxiliary contacts

3RT1. 1, 3RH11, 3RH14	20	2 -- -- --	▶	3RH19 11-1FA20	0.050	▶	3RH19 11-2FA20	0.050
	11	1 1 -- --	▶	3RH19 11-1FA11	0.050	▶	3RH19 11-2FA11	0.050
	02	-- 2 -- --	▶	3RH19 11-1FA02	0.050	▶	3RH19 11-2FA02	0.050
	11 U	-- -- 1 1	▶	3RH19 11-1FB11	0.050	A	3RH19 11-2FB11	0.050
	40	4 -- -- --	▶	3RH19 11-1FA40	0.060	▶	3RH19 11-2FA40	0.060
	31	3 1 -- --	▶	3RH19 11-1FA31	0.060	▶	3RH19 11-2FA31	0.060
	22	2 2 -- --	▶	3RH19 11-1FA22	0.060	▶	3RH19 11-2FA22	0.060
	22 U	-- -- 2 2	▶	3RH19 11-1FC22	0.060	▶	3RH19 11-2FC22	0.060
	11, 11 U	1 1 1 1	▶	3RH19 11-1FB22	0.060	B	3RH19 11-2FB22	0.060

1- and 2-pole auxiliary switch blocks with cable entry from one side

• Cable entry from above

3RT1. 1, 3RH11, 3RH14	--	1 -- -- --	▶	3RH19 11-1AA10	0.015	--		
	--	-- 1 -- --	▶	3RH19 11-1AA01	0.015	--		
	--	1 1 -- --	▶	3RH19 11-1LA11	0.045	--		
	--	2 -- -- --	▶	3RH19 11-1LA20	0.045	--		

• Cable entry from below

3RT1. 1, 3RH11, 3RH14	--	1 -- -- --	▶	3RH19 11-1BA10	0.015	--		
	--	-- 1 -- --	▶	3RH19 11-1BA01	0.015	--		
	--	1 1 -- --	▶	3RH19 11-1MA11	0.045	--		
	--	2 -- -- --	▶	3RH19 11-1MA20	0.045	--		

For multi-unit packing and reusable packaging, see "Appendix --> Order information".

¹⁾ Exception: 3RT12, 3RT16.

²⁾ With identification numbers 5, 6, 7, 8.

Accessories and Spare Parts

For 3RT, 3RH Contactors and Contactor Relays

Accessories for 3RT, 3RH contactors
and contactor relays

PU (UNIT, SET, M) = 1
PS* = 1 unit
PG = 101



3RH19 21-1F..



2RH19 21-2F..



3RH19 21-1C..



3RH19 21-2C..



3RH19 21-1LA..



3RH19 21-1MA..

For contactors	Auxiliary contacts	DT	Screw terminals	Weight per PU approx.	DT	Cage Clamp terminals	Weight per PU approx.
	Ident. No.	Version	Order No.	Price per PU		Order No.	Price per PU
Type	 NO NC NO NC			kg			kg

Auxiliary switch blocks for snapping onto the front according to EN 50005

Sizes S0 to S12¹⁾

4-pole auxiliary switch blocks											
3RT10 2,	40	4	--	--	--	▶	3RH19 21-1FA40	0.075	▶	3RH19 21-2FA40	0.075
3RT1. 3	31	3	1	--	--	▶	3RH19 21-1FA31	0.075	▶	3RH19 21-2FA31	0.075
...	22	2	2	--	--	▶	3RH19 21-1FA22	0.075	▶	3RH19 21-2FA22	0.075
3RT1. 7	04	--	4	--	--	▶	3RH19 21-1FA04	0.075 A		3RH19 21-2FA04	0.075
	22 U	--	--	2	2	▶	3RH19 21-1FC22	0.075 A		3RH19 21-2FC22	0.075
1-pole auxiliary switch blocks to EN 50005 and EN 50012											
3RT1. 2	--	1	--	--	--	▶	3RH19 21-1CA10	0.020	▶	3RH19 21-2CA10	0.020
...	--	--	1	--	--	▶	3RH19 21-1CA01	0.020	▶	3RH19 21-2CA01	0.020
3RT1. 7	--	--	--	1	--	▶	3RH19 21-1CD10	0.020		--	--
	--	--	--	--	1	▶	3RH19 21-1CD01	0.020		--	--
2-pole auxiliary switch blocks with cable entry from one side											
• Cable entry from above											
3RT1. 2,	--	1	1	--	--	▶	3RH19 21-1LA11	0.075		--	--
3RT1. 3	--	2	--	--	--	▶	3RH19 21-1LA20	0.075		--	--
...	--	--	2	--	--	▶	3RH19 21-1LA02	0.075		--	--
3RT1. 7	--	--	--	--	--	▶					
• Cable entry from below											
3RT1. 2,	--	1	1	--	--	▶	3RH19 21-1MA11	0.075		--	--
3RT1. 3	--	2	--	--	--	▶	3RH19 21-1MA20	0.075		--	--
...	--	--	2	--	--	▶	3RH19 21-1MA02	0.075		--	--
3RT1. 7	--	--	--	--	--	▶					

¹⁾ Exception: 3RT16.

Accessories and Spare Parts

For 3RT, 3RH Contactors and Contactor Relays

Accessories for 3RT, 3RH contactors and contactor relays

PU (UNIT, SET, M) = 1
 PS* = 1 unit
 PG = 101



3RH19 11-1GA..

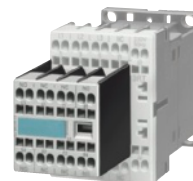

3RH19 11-2GA..

For contactor relays		Contacts	DT	Screw terminals		Weight per PU approx.	DT	Cage Clamp terminals		Weight per PU approx.
Ident. No.	Version			Order No.	Price per PU			Order No.	Price per PU	
						kg				kg
		NO	NC							

Snap-on auxiliary switch blocks according to EN 50011

For assembling contactor relays with 8 contacts

3RH11 40,	80E	4	--	▶	3RH19 11-1GA40	0.060 ▶	3RH19 11-2GA40	0.060
3RH14 40	71E	3	1	▶	3RH19 11-1GA31	0.060 ▶	3RH19 11-2GA31	0.060
(Ident. No. 40E)	62E	2	2	▶	3RH19 11-1GA22	0.060 ▶	3RH19 11-2GA22	0.060
	53E	1	3	▶	3RH19 11-1GA13	0.060 ▶	3RH19 11-2GA13	0.060
	44E	--	4	▶	3RH19 11-1GA04	0.060 ▶	3RH19 11-2GA04	0.060

For multi-unit packing and reusable packaging, see "Appendix --> Order information".

Accessories and Spare Parts For 3RT, 3RH Contactors and Contactor Relays

Accessories for 3RT, 3RH contactors and contactor relays

PU (UNIT, SET, M) = 1
 PS* = 1 unit
 PG = 101



3RH19 21-1DA11
3RH19 21-1JA11



3RH19 21-2DA11
3RH19 21-2JA11



3RH19 21-1EA...
3RH19 21-1KA...



3RH19 21-2EA...
3RH19 21-2KA...

For contactors	Auxiliary contacts	DT	Screw terminals	⊕	Weight per PU approx.	DT	Cage Clamp terminals	⊕	Weight per PU approx.
	Version		Order No.	Price per PU			Order No.	Price per PU	
Type	NO NC				kg				kg

Laterally mountable auxiliary switch blocks according to EN 50012

Sizes S0 ... S12

First laterally mountable auxiliary switch block (right or left), 2-pole

3RT1. 2 ... 3RT1. 7	1	1	▶	3RH19 21-1DA11	0.050	▶	3RH19 21-2DA11	0.050
---------------------	---	---	---	-----------------------	-------	---	-----------------------	-------

Sizes S3 ... S12

Second laterally mountable auxiliary switch block (right or left), 2-pole

3RT1. 4 ... 3RT1. 7	1	1	▶	3RH19 21-1JA11	0.050	▶	3RH19 21-2JA11	0.050
---------------------	---	---	---	-----------------------	-------	---	-----------------------	-------

Laterally mountable auxiliary switch blocks according to EN 50005

Sizes S0 ... S12

First laterally mountable auxiliary switch block (right or left), 2-pole

3RT1. 2 ... 3RT1. 7	2	--	▶	3RH19 21-1EA20	0.050	▶	3RH19 21-2EA20	0.050
	1	1	▶	3RH19 21-1EA11	0.050	▶	--	
	--	2	▶	3RH19 21-1EA02	0.050	▶	3RH19 21-2EA02	0.050

Sizes S3 ... S12

Second laterally mountable auxiliary switch block (right or left), 2-pole

3RT1. 4 ... 3RT1. 7	2	--	▶	3RH19 21-1KA20	0.050 D	▶	3RH19 21-2KA20	0.050
	1	1	▶	3RH19 21-1KA11	0.050	▶	--	
	--	2	▶	3RH19 21-1KA02	0.050 D	▶	3RH19 21-2KA02	0.050

* You can order this quantity or a multiple thereof.

Accessories and Spare Parts

For 3RT, 3RH Contactors and Contactor Relays

Accessories for 3RT, 3RH contactors and contactor relays

PU (UNIT, SET, M) = 1
 PS* = 1 unit
 PG = 101



3RH19 11-1NF..



3RH19 11-2NF..





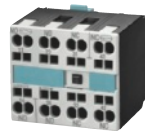

3RH19 21-1FE22



3RH19 21-2JE22

3RH19 21-2DE11
3RH19 21-2JE11

For contactors	Version	Contacts	DT	Screw terminals		Weight per PU approx.	DT	Cage Clamp terminals		Weight per PU approx.
				Order No.	Price per PU			Order No.	Price per PU	
		Version								
		   								
Type		NO NO ¹⁾ NC ¹⁾ NC				kg				kg

Solid-state compatible auxiliary switch blocks for snapping onto the front, according to EN 50005

Size S00

3RT1. 1, 3RH11, 3RH14	For operation in dusty atmosphere and solid-state circuits with rated operational currents $I_e/AC-14$ and DC-13 from 1 mA to 300 mA at 3 V to 60 V. Hard gold-plated contacts. No mirror contacts.	1 2 --	-- -- --	1 -- 2	▶ ▶ A	3RH19 11-1NF11 3RH19 11-1NF20 3RH19 11-1NF02	0.045 A 0.045 A 0.045 A	3RH19 11-2NF11 3RH19 11-2NF20 3RH19 11-2NF02	0.045 0.045 0.045
-----------------------------	---	--------------	----------------	--------------	-------------	---	-------------------------------	---	-------------------------

Sizes S0 ... S12

3RT1. 2 ... 3RT1. 7	For operation in dusty atmosphere and solid-state circuits with rated operational currents $I_e/AC-14$ and DC-13 from 1 mA to 300 mA at 3 V to 60 V. Hard gold-plated contacts. Mirror contacts acc. to EN 60947-4-1, Appendix F	1	1	1	1	▶	3RH19 21-1FE22	0.070 B	3RH19 21-2FE22	0.070
---------------------------	--	---	---	---	---	---	-----------------------	---------	-----------------------	-------

Solid-state compatible auxiliary switch blocks, laterally mountable, according to EN 50012

Sizes S0 ... S12

First laterally mountable auxiliary switch block (right or left), 2-pole

3RT1. 2 ... 3RT1. 7	1 NO + 1 NC solid-state compatible auxiliary switches For operation in dusty atmosphere and solid-state circuits with rated operational currents $I_e/AC-14$ and DC-13 from 1 mA to 300 mA at 3 V to 60 V. Hard gold-plated contacts. Mirror contacts acc. to EN 60947-4-1, Appendix F	1	--	--	1	--	▶	3RH19 21-2DE11	0.050
---------------------------	---	---	----	----	---	----	---	-----------------------	-------

Sizes S3 ... S12

Second laterally mountable auxiliary switch block (right or left), 2-pole

3RT1. 4 ... 3RT1. 7	1 NO + 1 NC solid-state compatible auxiliary switches For operation in dusty atmosphere and solid-state circuits with rated operational currents $I_e/AC-14$ and DC-13 from 1 mA to 300 mA at 3 V to 60 V. Hard gold-plated contacts. Mirror contacts acc. to EN 60947-4-1, Appendix F	1	--	--	1	--	▶	3RH19 21-2JE11	0.050
---------------------------	---	---	----	----	---	----	---	-----------------------	-------

¹⁾ 1 NO + 1 NC standard auxiliary switches:
 see Technical Information LV 1 T → "Technical specifications".

Accessories and Spare Parts

For 3RT, 3RH Contactors and Contactor Relays

Accessories for 3RT, 3RH contactors and contactor relays

For contactors	Auxiliary contacts	Rated control supply voltage $U_s^{1)}$	Time setting range t	DT	Order No.	Price per PU	PU (UNIT, SET, M)	PS*	PG	Weight per PU approx.
Type		V	s							kg

Solid-state time-delay auxiliary switch blocks for snapping onto the front, terminal designations according to DIN 46199-5

Size S00



3RT19 16-2....

ON-delay (varistor integrated)

3RT1. 1, 3RH11 ²⁾ 3RH14	1 NO + 1 NC	24 AC/DC ³⁾	0.05 ... 1	▶	3RT19 16-2EJ11		1	1 unit	101	0.090
			0.5 ... 10	▶	3RT19 16-2EJ21					
			5 ... 100	B	3RT19 16-2EJ31					
	100 ... 127 AC ³⁾			0.05 ... 1	C	3RT19 16-2EC11	1	1 unit	101	0.090
				0.5 ... 10	▶	3RT19 16-2EC21				
				5 ... 100	▶	3RT19 16-2EC31				
200 ... 240 AC ³⁾			0.05 ... 1	D	3RT19 16-2ED11	1	1 unit	101	0.090	
			0.5 ... 10	▶	3RT19 16-2ED21					
			5 ... 100	▶	3RT19 16-2ED31					

OFF-delay without auxiliary voltage (varistor integrated)⁴⁾

3RT1. 1, 3RH11 ²⁾ 3RH14	1 NO + 1 NC	24 AC/DC ³⁾	0.05 ... 1	▶	3RT19 16-2FJ11	1	1 unit	101	0.090	
			0.5 ... 10	▶	3RT19 16-2FJ21					
			5 ... 100	▶	3RT19 16-2FJ31					
	100 ... 127 AC/DC ³⁾			0.05 ... 1	C	3RT19 16-2FK11	1	1 unit	101	0.090
				0.5 ... 10	▶	3RT19 16-2FK21				
				5 ... 100	B	3RT19 16-2FK31				
200 ... 240 AC/DC ³⁾			0.05 ... 1	D	3RT19 16-2FL11	1	1 unit	101	0.090	
			0.5 ... 10	▶	3RT19 16-2FL21					
			5 ... 100	▶	3RT19 16-2FL31					

OFF-delay with auxiliary voltage

3RT10 1 3RH11	1 CO	24 AC/DC	0.5 ... 10	B	3RT19 16-2LJ21	1	1 unit	101	0.090
			100 ... 127 AC	B	3RT19 16-2LC21				
			200 ... 240 AC	C	3RT19 16-2LD21				

Wye-delta function (varistor integrated)

3RT10 1 ²⁾	1 NO	24 AC/DC ³⁾	1.5 ... 30	▶	3RT19 16-2GJ51	1	1 unit	101	0.090
			100 ... 127 AC ³⁾	▶	3RT19 16-2GC51				
			200 ... 240 AC ³⁾	▶	3RT19 16-2GD51				
			delayed + 1 NO instantaneous, dead time 50 ms						

Sizes S0 ... S12

With ON-delay

3RT10, 3RT13, 3RT14, 3RT15	1 NO + 1 NC	24 AC/DC ⁵⁾	0.05 ... 1	D	3RT19 26-2EJ11	1	1 unit	101	0.090	
			0.5 ... 10	▶	3RT19 26-2EJ21					
			5 ... 100	A	3RT19 26-2EJ31					
	100 ... 127 AC ⁵⁾			0.05 ... 1	C	3RT19 26-2EC11	1	1 unit	101	0.090
				0.5 ... 10	▶	3RT19 26-2EC21				
				5 ... 100	D	3RT19 26-2EC31				
200 ... 240 AC ⁵⁾			0.05 ... 1	D	3RT19 26-2ED11	1	1 unit	101	0.090	
			0.5 ... 10	▶	3RT19 26-2ED21					
			5 ... 100	B	3RT19 26-2ED31					

OFF-delay without auxiliary voltage⁴⁾

3RT10, 3RT13, 3RT14, 3RT15	1 NO + 1 NC	24 AC/DC ⁵⁾	0.05 ... 1	▶	3RT19 26-2FJ11	1	1 unit	101	0.090	
			0.5 ... 10	▶	3RT19 26-2FJ21					
			5 ... 100	▶	3RT19 26-2FJ31					
	100 ... 127 AC ⁵⁾			0.05 ... 1	D	3RT19 26-2FK11	1	1 unit	101	0.090
				0.5 ... 10	▶	3RT19 26-2FK21				
				5 ... 100	C	3RT19 26-2FK31				
200 ... 240 AC ⁵⁾			0.05 ... 1	D	3RT19 26-2FL11	1	1 unit	101	0.090	
			0.5 ... 10	A	3RT19 26-2FL21					
			5 ... 100	A	3RT19 26-2FL31					

Wye-delta function

3RT10, 3RT13, 3RT14, 3RT15	1 NO, delayed + 1 NO, instantaneous, dead time 50 ms	24 AC/DC ⁵⁾	1.5 ... 30	▶	3RT19 26-2GJ51	1	1 unit	101	0.090
			100 ... 127 AC ⁵⁾	▶	3RT19 26-2GC51				
			200 ... 240 AC ⁵⁾	▶	3RT19 26-2GD51				

1) The AC voltages are valid for 50 Hz and 60 Hz.

2) Cannot be fitted onto coupling relays.

3) The terminals for the control supply voltage are connected to the contactor by the integrated spring contacts of the solid-state time-delay auxiliary switch above it when this switch is mounted.

4) Setting of output contacts in as-supplied state not defined (bistable relay). Application of the control supply voltage once results in contact changeover to the correct setting.

5) Terminals A1 and A2 for the control supply voltage of the solid-state time-delay auxiliary switch must be connected to the associated contactor by means of connecting cables.

Accessories and Spare Parts

For 3RT, 3RH Contactors and Contactor Relays

Accessories for 3RT, 3RH contactors and contactor relays

For contactors	Rated control supply voltage U_s	Time setting range t	DT	Order No.	Price per PU	PU (UNIT, SET, M)	PS*	PG	Weight per PU approx.
Type	V	s							kg

Solid-state time-delay blocks with semiconductor output

Size S00



3RT19 16-2C...



3RT19 16-2D...

For mounting onto the front of contactors

• ON-delay (varistor integrated)

3RT1. 1, 3RH11 ¹⁾ 3RH14	24 ... 66 AC/DC	0.05 ... 1	B	3RT19 16-2CG11		1	1 unit	101	0.050
		0.5 ... 10	▶	3RT19 16-2CG21		1	1 unit	101	0.050
		5 ... 100	B	3RT19 16-2CG31		1	1 unit	101	0.050
3RT19 16-2C...	90 ... 240 AC/DC	0.05 ... 1	D	3RT19 16-2CH11		1	1 unit	101	0.050
		0.5 ... 10	▶	3RT19 16-2CH21		1	1 unit	101	0.050
		5 ... 100	▶	3RT19 16-2CH31		1	1 unit	101	0.050

• OFF-delay with auxiliary voltage (varistor integrated)

3RT1. 1, 3RH11 ¹⁾ 3RH14	24 ... 66 AC/DC	0.05 ... 1	C	3RT19 16-2DG11		1	1 unit	101	0.060
		0.5 ... 10	B	3RT19 16-2DG21		1	1 unit	101	0.060
		5 ... 100	B	3RT19 16-2DG31		1	1 unit	101	0.060
3RT19 16-2D...	90 ... 240 AC/DC	0.05 ... 1	D	3RT19 16-2DH11		1	1 unit	101	0.060
		0.5 ... 10	▶	3RT19 16-2DH21		1	1 unit	101	0.060
		5 ... 100	B	3RT19 16-2DH31		1	1 unit	101	0.060

Sizes S0 ... S3

For mounting onto coil terminals on top of the contactors

Only for devices with screw terminals

• ON-delay (varistor integrated)

3RT10 2, 3RT10 3, 3RT10 4, 3RT13 ²⁾ 3RT15	24 ... 66 AC/DC	0.05 ... 1	D	3RT19 26-2CG11		1	1 unit	101	0.050
		0.5 ... 10	B	3RT19 26-2CG21		1	1 unit	101	0.050
		5 ... 100	D	3RT19 26-2CG31		1	1 unit	101	0.050
3RT19 26-2C...	90 ... 240 AC/DC	0.05 ... 1	▶	3RT19 26-2CH11		1	1 unit	101	0.050
		0.5 ... 10	▶	3RT19 26-2CH21		1	1 unit	101	0.050
		5 ... 100	▶	3RT19 26-2CH31		1	1 unit	101	0.050

• OFF-delay with auxiliary voltage (varistor integrated)

3RT10 2, 3RT10 3, 3RT10 4, 3RT13 ²⁾ 3RT15	24 ... 66 AC/DC	0.05 ... 1	D	3RT19 26-2DG11		1	1 unit	101	0.050
		0.5 ... 10	D	3RT19 26-2DG21		1	1 unit	101	0.050
		5 ... 100	D	3RT19 26-2DG31		1	1 unit	101	0.050
3RT19 26-2D...	90 ... 240 AC/DC	0.05 ... 1	C	3RT19 26-2DH11		1	1 unit	101	0.050
		0.5 ... 10	D	3RT19 26-2DH21		1	1 unit	101	0.050
		5 ... 100	C	3RT19 26-2DH31		1	1 unit	101	0.050

OFF-delay devices



3RT19 16-2B.01

3RT1. 1, 3RT1. 2, 3RH1. ...-1BF40	110 AC/DC		D	3RT19 16-2BK01		1	1 unit	101	0.150	
	3RT1. 1, 3RT1. 2, 3RH1. ...-1BM40	220/230 AC/DC		D	3RT19 16-2BL01		1	1 unit	101	0.150
		3RT1. 1 ... 3RT1. 4, 3RH1. ...-1BB40	24 DC	▶	3RT19 16-2BE01		1	1 unit	101	0.150

Pneumatic delay blocks, terminal designation according to EN 50005



3RT19 26-2P...

3RT1. 2 For mounting onto the front side of size S0 contactors³⁾⁴⁾

Auxiliary contacts 1 NO and 1 NC

• ON-delay

0.1 ... 30	C	3RT19 26-2PA01	1	1 unit	101	0.080
1 ... 60	C	3RT19 26-2PA11	1	1 unit	101	0.080

• OFF-delay

0.1 ... 30	C	3RT19 26-2PR01	1	1 unit	101	0.080
1 ... 60	C	3RT19 26-2PR11	1	1 unit	101	0.080

Mechanical latching blocks

Sizes S0 and S2



3RT19 26-3A.31

For mounting on 1 contactor, contactor remains in the energized state even after a voltage failure

3RT1. 2, 3RT1. 3	24 AC/DC		A	3RT19 26-3AB31		1	1 unit	101	0.130
	110 AC/DC		B	3RT19 26-3AF31		1	1 unit	101	0.130
	230 AC/DC		B	3RT19 26-3AP31		1	1 unit	101	0.130

¹⁾ Cannot be fitted onto coupling relays.

²⁾ Not to be used for 3RT10 4. and 3RT13 4. contactors with $U_s \leq 42$ V.

³⁾ In addition to these, no other auxiliary contacts are permitted.

⁴⁾ Versions according to DIN VDE 0116 on request.

Accessories and Spare Parts

For 3RT, 3RH Contactors and Contactor Relays

Accessories for 3RT, 3RH contactors and contactor relays

For contactors	Version	Rated control supply voltage U_s 1)		DT	Order No. 2)	Price per PU	PU (UNIT, SET, M)	PS*	PG	Weight per PU approx.
		AC operation	DC operation							
Type		V AC	V DC							kg

Surge suppressors without LED (also for Cage Clamp terminals)

Size S00



3RT19 16-1DG00

For plugging onto the front side of the contactors with and without auxiliary switch blocks

3RT1.., 3RH1	Varistors	24 ... 48	24 ... 70	▶	3RT19 16-1BB00	1	1 unit	101	0.010
		48 ... 127	70 ... 150	▶	3RT19 16-1BC00	1	1 unit	101	0.010
		127 ... 240	150 ... 250	A	3RT19 16-1BD00	1	1 unit	101	0.010
		240 ... 400	--	▶	3RT19 16-1BE00	1	1 unit	101	0.010
		400 ... 600	--	A	3RT19 16-1BF00	1	1 unit	101	0.010
3RT1.., 3RH1	RC elements	24 ... 48	24 ... 70	▶	3RT19 16-1CB00	1	1 unit	101	0.010
		48 ... 127	70 ... 150	▶	3RT19 16-1CC00	1	1 unit	101	0.010
		127 ... 240	150 ... 250	▶	3RT19 16-1CD00	1	1 unit	101	0.010
		240 ... 400	--	▶	3RT19 16-1CE00	1	1 unit	101	0.010
		400 ... 600	--	▶	3RT19 16-1CF00	1	1 unit	101	0.010
3RT1.., 3RH1	Noise suppression diodes	--	12 ... 250	▶	3RT19 16-1DG00	1	1 unit	101	0.010
3RT1.., 3RH1	Diode assemblies (diode and Zener diode) for DC operation	--	12 ... 250	▶	3RT19 16-1EH00	1	1 unit	101	0.010

Size S0



3RT19 26-1B.00

For fitting onto the coil terminals at top or bottom

3RT1. 2	Varistors	24 ... 48	24 ... 70	▶	3RT19 26-1BB00	1	1 unit	101	0.025	
		48 ... 127	70 ... 150	▶	3RT19 26-1BC00	1	1 unit	101	0.025	
		127 ... 240	150 ... 250	▶	3RT19 26-1BD00	1	1 unit	101	0.025	
		240 ... 400	--	▶	3RT19 26-1BE00	1	1 unit	101	0.025	
		400 ... 600	--	B	3RT19 26-1BF00	1	1 unit	101	0.025	
3RT1. 2	RC elements	24 ... 48	24 ... 70	▶	3RT19 26-1CB00	1	1 unit	101	0.025	
		48 ... 127	70 ... 150	▶	3RT19 26-1CC00	1	1 unit	101	0.025	
		127 ... 240	150 ... 250	▶	3RT19 26-1CD00	1	1 unit	101	0.025	
		240 ... 400	--	▶	3RT19 26-1CE00	1	1 unit	101	0.025	
		400 ... 600	--	B	3RT19 26-1CF00	1	1 unit	101	0.025	
3RT1. 2	Diode assemblies For DC operation									
		• Connectable at the top (e. g. for contactor with overload relay)	--	24	▶	3RT19 26-1ER00	1	1 unit	101	0.025
			--	30 ... 250	▶	3RT19 26-1ES00	1	1 unit	101	0.025
		• Connectable at the bottom (e. g. for fuseless load feeders)	--	24	▶	3RT19 26-1TR00	1	1 unit	101	0.025
			--	30 ... 250	A	3RT19 26-1TS00	1	1 unit	101	0.025

1) Can be used for AC operation for 50/60 Hz. Please inquire about further voltages.

2) For packs of 10 units, the Order No. must be supplemented with "-Z" and the order code "X90".

Accessories and Spare Parts

For 3RT, 3RH Contactors and Contactor Relays

Accessories for 3RT, 3RH contactors and contactor relays

For contactors	Version	Rated control supply voltage $U_s^{1)}$		DT	Order No. ²⁾	Price per PU	PU (UNIT, SET, M)	PS*	PG	Weight per PU approx.
		AC operation	DC operation							
Type		V AC	V DC							kg

Surge suppressors without LED (also for Cage Clamp terminals)

Sizes S2 and S3

For fitting onto the coil terminals at top or bottom



3RT19 26-1B.00

3RT1. 3, 3RT1. 4	Varistors	24 ... 48	24 ... 70	▶	3RT19 26-1BB00		1	1 unit	101	0.025
		48 ... 127	70 ... 150	▶	3RT19 26-1BC00		1	1 unit	101	0.025
		127 ... 240	150 ... 250	▶	3RT19 26-1BD00		1	1 unit	101	0.025
		240 ... 400	--	▶	3RT19 26-1BE00		1	1 unit	101	0.025
		400 ... 600	--	▶	3RT19 26-1BF00		1	1 unit	101	0.025



3RT19 36-1C.00

3RT1. 3 ³⁾ , 3RT1. 4	RC elements	24 ... 48	24 ... 70	▶	3RT19 36-1CB00		1	1 unit	101	0.040
		48 ... 127	70 ... 150	▶	3RT19 36-1CC00		1	1 unit	101	0.040
		127 ... 240	150 ... 250	▶	3RT19 36-1CD00		1	1 unit	101	0.040
		240 ... 400	--	▶	3RT19 36-1CE00		1	1 unit	101	0.040
		400 ... 600	--	▶	3RT19 36-1CF00		1	1 unit	101	0.040

Diode assemblies

For DC operation

- Connectable at the top (e. g. for contactor with overload relay)

24	▶	3RT19 36-1ER00		1	1 unit	101	0.025
30 ... 250	▶	3RT19 36-1ES00		1	1 unit	101	0.025

- Connectable at the bottom (e. g. for fuseless load feeders)

24	▶	3RT19 36-1TR00		1	1 unit	101	0.025
30 ... 250	▶	3RT19 36-1TS00		1	1 unit	101	0.025

Sizes S6 ... S12

For connecting to withdrawable coil with screw terminals with contactors with

- **3RT1. ...A...** conventional operating mechanism
- **3RT1. ...N...** conventional operating mechanism



3RT19 56-1C.00

3RT1. 5, 3RT1. 6, 3RT1. 7	RC elements	24 ... 48	24 ... 70	▶	3RT19 56-1CB00		1	1 unit	101	0.035
		48 ... 127	70 ... 150	▶	3RT19 56-1CC00		1	1 unit	101	0.035
		127 ... 240	150 ... 250	▶	3RT19 56-1CD00		1	1 unit	101	0.035
		240 ... 400	--	▶	3RT19 56-1CE00		1	1 unit	101	0.035
		400 ... 600	--	▶	3RT19 56-1CF00		1	1 unit	101	0.035

- Can be used for AC operation for 50/60 Hz. Please inquire about further voltages.
- For packs of 10 or 5 units "-Z" and order code "X90" must be added to the Order No.
- Mountable only at the top for 3RT1. 3/AC operating mechanism.

For contactors	Version	Rated control supply voltage $U_s^{1)}$		Power consumption of LED at U_s	DT	Order No. ²⁾	Price per PU	PU (UNIT, SET, M)	PS*	PG	Weight per PU approx.
		AC operation	DC operation								
Type		V AC	V DC								kg

Surge suppressors with LED (also for Cage Clamp terminals)

Size S00

For plugging onto the front side of the contactors with and without auxiliary switch blocks



3RT19 16-1L.00

3RT1, 3RH1.	Varistors	24 ... 48	12 ... 24	10 ... 120	▶	3RT19 16-1JJ00		1	1 unit	101	0.010
		48 ... 127	24 ... 70	20 ... 470	▶	3RT19 16-1JK00		1	1 unit	101	0.010
		127 ... 240	70 ... 150	50 ... 700	▶	3RT19 16-1JL00		1	1 unit	101	0.010
		--	150 ... 250	160 ... 950	▶	3RT19 16-1JP00		1	1 unit	101	0.010
3RT1, 3RH1.	Noise suppression diodes	--	24 ... 70	20 ... 470	▶	3RT19 16-1LM00		1	1 unit	101	0.010
		--	50 ... 150	50 ... 700	▶	3RT19 16-1LN00		1	1 unit	101	0.010
		--	150 ... 250	160 ... 950	▶	3RT19 16-1LP00		1	1 unit	101	0.010

- Can be used for AC operation for 50/60 Hz. Please inquire about further voltages.
- For packs of 10 or 5 units "-Z" and order code "X90" must be added to the Order No.

Accessories and Spare Parts

For 3RT, 3RH Contactors and Contactor Relays

Accessories for 3RT, 3RH contactors and contactor relays

For contactors	Version	DT	Order No.	Price per PU	PU (UNIT, SET, M)	PS*	PG	Weight per PU approx. kg	
EMC suppression modules; 3-phase ≤ 5.5 kW									
<i>Size S00 (for contactors with AC or DC operation)¹⁾</i>									
	3RT10 1	RC elements (3 x 220 Ω/0.22 μF) Up to 400 V Up to 575 V Up to 690 V	▶	3RT19 16-1PA1		1	1 unit	101	0.080
			A	3RT19 16-1PA2		1	1 unit	101	0.080
			C	3RT19 16-1PA3		1	1 unit	101	0.080
	3RT10 1	Varistors Up to 400 V Up to 575 V Up to 690 V	A	3RT19 16-1PB1		1	1 unit	101	0.090
			B	3RT19 16-1PB2		1	1 unit	101	0.090
			D	3RT19 16-1PB3		1	1 unit	101	0.090

3RT19 16-1PA.

Main current path surge suppression modules for 3RT12 vacuum contactors

Size S10 and S12

3RT12	Rated operational voltage $U_e = 690$ V AC	C	3RT19 66-1PV3		1	1 unit	101	0.400
	Rated operational voltage $U_e = 1000$ V AC For damping overvoltages and protecting motor windings against multiple re-ignition when switching off induction motors. For connection on the contactor feeder side (2-T1/4-T2/6-T3). For separate installation.	C	3RT19 66-1PV4		1	1 unit	101	0.780

Additional load modules

Size S00 (also for Cage Clamp terminals)

For plugging onto the front side of the contactors with and without auxiliary switch blocks²⁾

	3RT1. 1, 3RH1.	For increasing the permissible residual current and for limiting the residual voltage. Ensures safe opening of contactors with direct control via 230 V AC semiconductor outputs of SIMATIC controllers. Also performs the function of an overvoltage damping circuit. Rated voltage: 50/60 Hz, 180 V to 255 V AC. Operating range: 0.8 to 1.1 x U_s	▶	3RT19 16-1GA00		1	1 unit	101	0.010

3RT19 16-1GA00

Control kits

Size S00

	3RT1. 1, 3RH1.	For manual operation of the contactor contacts for start-up and service ³⁾	A	3RK1 903-0CA00		1	1 unit	121	0.015

3RK1 903-0CA00

¹⁾ See also description on page 3/98.

²⁾ For packs of 10 units, the Order No. must be supplemented with "-Z" and the order code "X90".

³⁾ See "Load Feeders, Motor Starters and Soft Starters --> ET 200S Motor Starters, 3RK1 903-0CA00".

Accessories and Spare Parts

For 3RT, 3RH Contactors and Contactor Relays

Accessories for 3RT, 3RH contactors and contactor relays

For contactors	Version	DT	Order No.	Price per PU	PU (UNIT, SET, M)	PS*	PG	Weight per PU approx. kg
----------------	---------	----	-----------	--------------	-------------------	-----	----	--------------------------

Coupling links for control by PLC

Sizes S0 ... S3

For mounting onto the coil terminals of the contactors



3RH19 24-1GP11

3RT1 . 2, 3RT1 . 3, 3RT1 . 4
 Operating range 17 to 30 V DC
 Power consumption: 0.5 W at 24 V DC
 Permissible residual current of the electronics (for 0 signal): 2.5 mA
 Rated operational current I_e :
 AC-15/AC-14 at 230 V: 3 A, DC-13 at 230 V: 0.1 A
 With LED for indicating switching state.
 With integrated varistor for damping opening surges.

▶ **3RH19 24-1GP11** 1 1 unit 101 0.060

LED modules for indicating the contactor function (also for Cage Clamp terminals)

Sizes S0 ... S12¹⁾



3RT19 26-1QT00 mounted to contactor

3RT1 . 2, 3RT1 . 3, 3RT1 . 4
 For snapping into the location hole of an inscription label on the front of a contactor either directly on the contactor or on the front auxiliary switch.
 The LED module is connected to coil terminals A1 and A2 of the contactor and indicates its energized state. Yellow LED.
 Rated voltage: 24 to 240 V AC/DC, polarized.
 (1 pack = 5 units)

B **3RT19 26-1QT00** 1 5 units 101 0.010

Auxiliary terminals, 3-pole

Size S3



3RT19 46-4F

3RT10 4.
 For connection of auxiliary and control cables (0.5 to 2.5 mm²) to the main conductor connections (for one side)

B **3RT19 46-4F** 1 1 unit 101 0.035

Solder pin adapters for contactors

Size S00



3RT19 16-4KA1

3RT1 . 1, 3RH11
 Assembly kit for soldering contactors onto a printed circuit board.
 For 1 contactor, 1 set is required.

A **3RT19 16-4KA1** 1 4 units 101 0.030

Connection modules for contactors with screw terminals

Size S00, S0



3RT19 26-4RD01

3RT1 . 1, 3RT1 . 2, 3RH1.
Adapters for contactors
 Ambient temperature $T_{u \text{ max.}} = 60 \text{ }^\circ\text{C}$
 Size S00, rated operational current I_e at AC-3/400 V: 20 A
 Size S0, rated operational current I_e at AC-3/400 V: 25 A

Screw terminals

B **3RT19 16-4RD01** 1 1 unit 101 0.020

B **3RT19 26-4RD01** 1 1 unit 101 0.200



3RT19 00-4RE01

Plugs for contactors
 Size S00, S0

B **3RT19 00-4RE01** 1 1 unit 101 0.025

¹⁾ For sizes S6 ... S12 the connecting leads have to be extended.

Accessories and Spare Parts

For 3RT, 3RH Contactors and Contactor Relays

Accessories for 3RT, 3RH contactors and contactor relays

For contactors	Version	DT	Order No.	Price per PU	PU (UNIT, SET, M)	PS*	PG	Weight per PU approx. kg
----------------	---------	----	-----------	--------------	-------------------	-----	----	--------------------------

Solder pin adapters for contactors with mounted 4-pole auxiliary switch block

Size S00

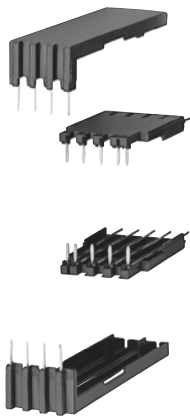

3RT19 16-4KA2

3RT1. 1, 3RH11 Assembly kit for soldering contactors B with an auxiliary switch block onto a printed circuit board. For 1 contactor, 1 set is required.

3RT19 16-4KA2 1 4 units 101 0.070

Screw adapters with screw or Cage Clamp terminals

Size S0

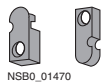

3RT19 26-4P

3RT1. 2 Screw adapters for easy screw fixing C 2 units required per contactor (1 pack contains 10 sets for 10 contactors)

3RT19 26-4P 1 10 units 101 0.010

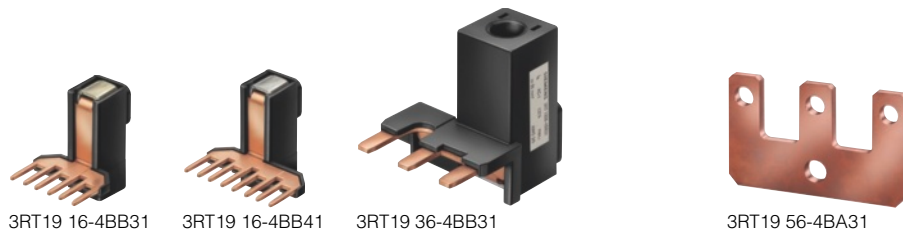

3RT19 16-4BB31

3RT19 16-4BB41

3RT19 36-4BB31

3RT19 56-4BA31

Size	For contactors	Max. conductor cross-sections	DT	Order No.	Price per PU	PU (UNIT, SET, M)	PS*	PG	Weight per PU approx. kg
------	----------------	-------------------------------	----	-----------	--------------	-------------------	-----	----	--------------------------

Type mm²

Links for paralleling

3-pole, with connection terminal ¹⁾²⁾									
S00	3RT10 1	25	▶	3RT19 16-4BB31		1	1 unit	101	0.015
S0	3RT10 2	35, stranded	▶	3RT19 26-4BB31		1	1 unit	101	0.020
S2	3RT10 3	95	▶	3RT19 36-4BB31		1	1 unit	101	0.100
3-pole, with through-hole (star jumpers) ¹⁾²⁾									
S3	3RT10 4 3RT14 4	185	▶	3RT19 46-4BB31		1	1 unit	101	0.200
S6	3RT1. 5	--	▶	3RT19 56-4BA31		1	1 unit	101	0.160
S10/S12	3RT1. 6, 3RT1. 7	--	▶	3RT19 66-4BA31		1	1 unit	101	0.500
4-pole, with connection terminal ¹⁾²⁾									
S00	3RT1. 1	25	C	3RT19 16-4BB41		1	1 unit	101	0.015

¹⁾ The links for paralleling can be reduced by one pole.

²⁾ Sizes S00 to S2: The links for paralleling are insulated.
Size S3: A cover plate is included for touch protection.
(Can only be used when the box terminal is removed.)
Sizes S6 to S12: The 3RT19 56-4EA1 (for S6) or 3RT19 66-4EA1 (for S10 and S12) cover can be used for touch protection.

Accessories and Spare Parts

For 3RT, 3RH Contactors and Contactor Relays

Accessories for 3RT, 3RH contactors and contactor relays

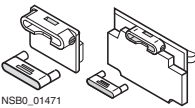
For contactors	Version		DT	Order No.	Price per PU	PU (UNIT, SET, M)	PS*	PG	Weight per PU approx. kg
	Size	Type							
Box terminal blocks									
	S6	3RT1. 5 (3RB20 5)	For round and ribbon cables¹⁾						
			Up to 70 mm ² 2)	▶	3RT19 55-4G	1	1 unit	101	0.230
			Up to 120 mm ²	▶	3RT19 56-4G	1	1 unit	101	0.260
			Auxiliary conductor connection for box terminals	B	3TX7 500-0A	1	1 unit	101	0.010
S10/S12	3RT1. 6, 3RT1. 7 (3RB20 6, 3RB21 6)	Up to 240 mm ² With auxiliary conductor connection	▶	3RT19 66-4G	1	1 unit	101	0.676	
Covers									
	S2	3RT10 3 3RT13 3, 3RT15 3	Terminal covers for box terminals						
			Additional touch protection to be fitted at the box terminals (2 units required per contactor) 4-pole contactors	B	3RT19 36-4EA2	1	1 unit	101	0.020
	S3	3RT10 4, 3RT14 4 3RT13 4	▶	3RT19 46-4EA2	1	1 unit	101	0.025	
			B	3RT19 46-4EA4	1	1 unit	101	0.025	
	S6	3RT1. 5	Length: 25 mm	▶	3RT19 56-4EA2	1	1 unit	101	0.030
S10/S12	3RT1. 6, 3RT1. 7	Length: 30 mm	▶	3RT19 66-4EA2	1	1 unit	101	0.040	
	S3	3RT10 4, 3RT14 4	Terminal covers for cable lugs and busbar connection³⁾						
			For complying with the voltage clearances and as touch protection if box terminal is removed ⁴⁾ (2 units required per contactor)	▶	3RT19 46-4EA1	1	1 unit	101	0.040
	S6	3RT1. 5	Length: 100 mm	▶	3RT19 56-4EA1	1	1 unit	101	0.070
	S10/S12	3RT1. 6, 3RT1. 7	Length: 120 mm	▶	3RT19 66-4EA1	1	1 unit	101	0.130
S6	3RT1. 5	For busbar cover between contactor and 3RB2. overload relay or wiring module for contactor assemblies		▶	3RT19 56-4EA3	1	1 unit	101	0.020
		Length: 27 mm	▶	3RT19 66-4EA3	1	1 unit	101	0.060	
S10/S12⁵⁾	3RT1. 6, 3RT1. 7	Length: 42 mm	▶						
S6	3RT1. 5	For busbar cover of the flat line connectors for reversing and wye-delta assemblies		▶	3RT19 56-4EA4	1	1 unit	101	0.030
Sealable covers									
	S00	3RT1. 1, 3RH1. 6)	Sealable cover for preventing manual operation	A	3RT19 16-4MA10	1	5 units	101	0.010
	S0 ... S12	3RT1. 2 ... 3RT1. 7 6)	1 unit required per contactor	B	3RT19 26-4MA10	1	5 units	101	0.010

¹⁾ For connectable cross-sections of the contactors see Technical Information LV 1 T -> "Technical specifications".

²⁾ As standard for 3RT10 54-1 contactor (55 kW).

³⁾ Also fits on contactors S6 ... S12 with box terminals.

⁴⁾ Observe the note in Technical Information LV 1 T, "Technical specifications", "Conductor Cross-Sections".



⁵⁾ The 3RT19 66-4EA3 cover is required in addition for use in contactor assemblies (reversing/wye-delta).

⁶⁾ Exception: contactors and contactor relays auxiliary switch block mounted onto the front.

Accessories and Spare Parts

For 3RT, 3RH Contactors and Contactor Relays

Accessories for 3RT, 3RH contactors and contactor relays

Version	DT	Order No.	Price per PU	PU (UNIT, SET, M)	PS*	PG	Weight per PU approx. kg
Insulation stop for securely holding back the conductor insulation on conductors up to 1 mm² for contactors with Cage Clamp terminals							
		3RT19 16-4JA02		100	20 unit	101	1000.000
3RT19 16-4JA02	B	Insulation stop strip can be inserted in cable entry of Cage Clamp (2 strips per contactor required, can be removed in pairs) Fits into cable entries of all SIRIUS devices with Cage Clamp terminals of conductor cross-section up to 2.5 mm ² .					
Tools for opening Cage Clamp terminals							
		8WA2 880		1	1 unit	041	0.034
8WA2 880	C	For all SIRIUS devices with Cage Clamp terminals, up to max. 2.5 mm ² conductor cross-section (not suitable for devices with removable terminal) Length: approx. 175 mm; 3.5 x 0.5, green; partially insulated					
	C	8WA2 803		1	1 unit	041	0.024
		Length: approx. 175 mm; 3.5 x 0.5; green					
Blank labels							
		Unit labeling plates for "SIRIUS"					
	D	3RT19 00-1SB10		100	816 units	101	24.000
		• 10 mm x 7 mm, pastel turquoise					
	C	3RT19 00-1SB20		100	340 units	101	0.200
		• 20 mm x 7 mm, pastel turquoise					
		Labels for sticking for "SIRIUS"					
3RT19 00-1SB10	D	3RT19 00-1SB60		100	3060 units	101	15.000
		• 19 mm x 6 mm, pastel turquoise					
	C	3RT19 00-1SD60		100	3060 units	101	12.000
		• 19 mm x 6 mm, zinc/yellow					
		<u>Computer labeling system</u> For individual inscription of unit labeling plates					
		Obtainable from: murrplastik Systemtechnik GmbH					

Accessories and Spare Parts

For 3RT, 3RH Contactors and Contactor Relays

Spare parts for 3RT, 3RH contactors and contactor relays

Selection and ordering data

PU (UNIT, SET, M) = 1
PS* = 1 unit
PG = 101



3RT19 24-5A.01



3RT19 34-5A.01



3RT19 24-5A.02

For contactors		Rated control supply voltage U_s			DT	Screw terminals	⊕	Weight per PU approx.	DT	Cage Clamp terminals	⊗	Weight per PU approx.	
		50 Hz	50/60 Hz	60 Hz		Order No.	Price per PU			Order No.	Price per PU		
Size	Type	V	V	V				kg				kg	
Solenoid coils · AC operation													
S0	3RT10 2.,	24	--	--	▶	3RT19 24-5AB01		0.100 B		3RT19 24-5AB02		0.100	
	3RT13 2.,	42	--	--	B	3RT19 24-5AD01		0.100 C		3RT19 24-5AD02		0.100	
	3RT15 2.	48	--	--	A	3RT19 24-5AH01		0.100 B		3RT19 24-5AH02		0.100	
		110	--	--	▶	3RT19 24-5AF01		0.100 B		3RT19 24-5AF02		0.100	
		230	--	--	▶	3RT19 24-5AP01		0.100 B		3RT19 24-5AP02		0.100	
		400	--	--	▶	3RT19 24-5AV01		0.100 C		3RT19 24-5AV02		0.100	
		--	24	--	▶	3RT19 24-5AC21		0.100 B		3RT19 24-5AC22		0.100	
		--	42	--	B	3RT19 24-5AD21		0.100 C		3RT19 24-5AD22		0.100	
		--	48	--	B	3RT19 24-5AH21		0.100 C		3RT19 24-5AH22		0.100	
		--	110	--	▶	3RT19 24-5AG21		0.100 B		3RT19 24-5AG22		0.100	
		--	220	--	B	3RT19 24-5AN21		0.100 B		3RT19 24-5AN22		0.100	
		--	230	--	B	3RT19 24-5AL21		0.100 B		3RT19 24-5AL22		0.100	
		110	--	120	B	3RT19 24-5AK61		0.100 B		3RT19 24-5AK62		0.100	
		220	--	240	B	3RT19 24-5AP61		0.100 C		3RT19 24-5AP62		0.100	
		--	100	110	B	3RT19 24-5AG61		0.100 C		3RT19 24-5AG62		0.100	
		--	200	220	B	3RT19 24-5AN61		0.100 C		3RT19 24-5AN62		0.100	
		--	400	440	B	3RT19 24-5AR61		0.100 C		3RT19 24-5AR62		0.100	
	S2	3RT10 34	24	--	--	B	3RT19 34-5AB01		0.120 B		3RT19 34-5AB02		0.120
			42	--	--	B	3RT19 34-5AD01		0.120 B		3RT19 34-5AD02		0.120
			48	--	--	B	3RT19 34-5AH01		0.120 B		3RT19 34-5AH02		0.120
110			--	--	B	3RT19 34-5AF01		0.120 B		3RT19 34-5AF02		0.120	
230			--	--	A	3RT19 34-5AP01		0.120 B		3RT19 34-5AP02		0.120	
400			--	--	C	3RT19 34-5AV01		0.120 B		3RT19 34-5AV02		0.120	
		--	24	--	B	3RT19 34-5AC21		0.120 B		3RT19 34-5AC22		0.120	
		--	42	--	B	3RT19 34-5AD21		0.120 B		3RT19 34-5AD22		0.120	
		--	48	--	B	3RT19 34-5AH21		0.120 B		3RT19 34-5AH22		0.120	
		--	110	--	C	3RT19 34-5AG21		0.120 B		3RT19 34-5AG22		0.120	
		--	220	--	C	3RT19 34-5AN21		0.120 B		3RT19 34-5AN22		0.120	
		--	230	--	C	3RT19 34-5AL21		0.120 B		3RT19 34-5AL22		0.120	
		110	--	120	B	3RT19 34-5AK61		0.120 B		3RT19 34-5AK62		0.120	
		220	--	240	B	3RT19 34-5AP61		0.120 B		3RT19 34-5AP62		0.120	
		--	100	110	B	3RT19 34-5AG61		0.120 B		3RT19 34-5AG62		0.120	
		--	200	220	B	3RT19 34-5AN61		0.120 B		3RT19 34-5AN62		0.120	
		--	400	440	B	3RT19 34-5AR61		0.120 B		3RT19 34-5AR62		0.120	
		3RT10 35, 3RT10 36, 3RT13 3., 3RT15 3.	24	--	--	B	3RT19 35-5AB01		0.120 B		3RT19 35-5AB02		0.120
			42	--	--	B	3RT19 35-5AD01		0.120 B		3RT19 35-5AD02		0.120
			48	--	--	B	3RT19 35-5AH01		0.120 B		3RT19 35-5AH02		0.120
	110		--	--	▶	3RT19 35-5AF01		0.120 B		3RT19 35-5AF02		0.120	
	230		--	--	▶	3RT19 35-5AP01		0.120 B		3RT19 35-5AP02		0.120	
	400		--	--	C	3RT19 35-5AV01		0.120 B		3RT19 35-5AV02		0.120	
		--	24	--	B	3RT19 35-5AC21		0.120 B		3RT19 35-5AC22		0.120	
		--	42	--	B	3RT19 35-5AD21		0.120 B		3RT19 35-5AD22		0.120	
		--	48	--	B	3RT19 35-5AH21		0.120 B		3RT19 35-5AH22		0.120	
		--	110	--	B	3RT19 35-5AG21		0.120 B		3RT19 35-5AG22		0.120	
		--	220	--	B	3RT19 35-5AN21		0.120 B		3RT19 35-5AN22		0.120	
		--	230	--	B	3RT19 35-5AL21		0.120 B		3RT19 35-5AL22		0.120	
		110	--	120	B	3RT19 35-5AK61		0.120 B		3RT19 35-5AK62		0.120	
		220	--	240	B	3RT19 35-5AP61		0.120 B		3RT19 35-5AP62		0.120	
		--	100	110	B	3RT19 35-5AG61		0.120 B		3RT19 35-5AG62		0.120	
		--	200	220	B	3RT19 35-5AN61		0.120 B		3RT19 35-5AN62		0.120	
		--	400	440	C	3RT19 35-5AR61		0.120 B		3RT19 35-5AR62		0.120	

* You can order this quantity or a multiple thereof.

Accessories and Spare Parts

For 3RT, 3RH Contactors and Contactor Relays

Spare parts for 3RT, 3RH
contactors and contactor relays

PU (UNIT, SET, M) = 1
PS* = 1 unit
PG = 101



3RT19 44-5A.01



3RT19 45-5A.01



3RT19 45-5A.02



3RT19 44-5B.42

For contactors		Rated control supply voltage U_s				DT	Screw terminals	⊕	Weight per PU approx.	DT	Cage Clamp terminals	⊖	Weight per PU approx.
Size	Type	AC			DC	Order No.	Price per PU	kg	Order No.	Price per PU	kg		
		50 Hz	50/60 Hz	60 Hz	V								
Solenoid coils · AC operation													
S3	3RT10 44	24	--	--	--	B	3RT19 44-5AB01	0.190 B	3RT19 44-5AB02	0.190			
		42	--	--	--	B	3RT19 44-5AD01	0.190 B	3RT19 44-5AD02	0.190			
		48	--	--	--	B	3RT19 44-5AH01	0.190 B	3RT19 44-5AH02	0.190			
		110	--	--	--	B	3RT19 44-5AF01	0.190 B	3RT19 44-5AF02	0.190			
		230	--	--	--	B	3RT19 44-5AP01	0.190 B	3RT19 44-5AP02	0.190			
		400	--	--	--	B	3RT19 44-5AV01	0.190 B	3RT19 44-5AV02	0.190			
		--	24	--	--	B	3RT19 44-5AC21	0.190 B	3RT19 44-5AC22	0.190			
		--	42	--	--	B	3RT19 44-5AD21	0.190 B	3RT19 44-5AD22	0.190			
		--	48	--	--	B	3RT19 44-5AH21	0.190 B	3RT19 44-5AH22	0.190			
		--	110	--	--	B	3RT19 44-5AG21	0.190 B	3RT19 44-5AG22	0.190			
		--	220	--	--	B	3RT19 44-5AN21	0.190 B	3RT19 44-5AN22	0.190			
		--	230	--	--	B	3RT19 44-5AL21	0.190 B	3RT19 44-5AL22	0.190			
	110	--	120	--	C	3RT19 44-5AK61	0.190 B	3RT19 44-5AK62	0.190				
	220	--	240	--	B	3RT19 44-5AP61	0.190 B	3RT19 44-5AP62	0.190				
	--	100	110	--	B	3RT19 44-5AG61	0.190 B	3RT19 44-5AG62	0.190				
	--	200	220	--	B	3RT19 44-5AN61	0.190 B	3RT19 44-5AN62	0.190				
	--	400	440	--	B	3RT19 44-5AR61	0.190 B	3RT19 44-5AR62	0.190				
	3RT10 45, 3RT10 46, 3RT13 4., 3RT14 46, 3RT15 4.	24	--	--	--	B	3RT19 45-5AB01	0.190 B	3RT19 45-5AB02	0.190			
		42	--	--	--	B	3RT19 45-5AD01	0.190 B	3RT19 45-5AD02	0.190			
		48	--	--	--	B	3RT19 45-5AH01	0.190 B	3RT19 45-5AH02	0.190			
		110	--	--	--	B	3RT19 45-5AF01	0.190 B	3RT19 45-5AF02	0.190			
		230	--	--	▶	3RT19 45-5AP01	0.190 B	3RT19 45-5AP02	0.190				
		400	--	--	C	3RT19 45-5AV01	0.190 B	3RT19 45-5AV02	0.190				
		--	24	--	--	B	3RT19 45-5AC21	0.190 B	3RT19 45-5AC22	0.190			
	--	42	--	--	B	3RT19 45-5AD21	0.190 B	3RT19 45-5AD22	0.190				
	--	48	--	--	B	3RT19 45-5AH21	0.190 B	3RT19 45-5AH22	0.190				
	--	110	--	--	B	3RT19 45-5AG21	0.190 B	3RT19 45-5AG22	0.190				
	--	220	--	--	B	3RT19 45-5AN21	0.190 B	3RT19 45-5AN22	0.190				
	--	230	--	--	B	3RT19 45-5AL21	0.190 B	3RT19 45-5AL22	0.190				
	110	--	120	--	B	3RT19 45-5AK61	0.190 B	3RT19 45-5AK62	0.190				
	220	--	240	--	B	3RT19 45-5AP61	0.190 B	3RT19 45-5AP62	0.190				
	--	100	110	--	B	3RT19 45-5AG61	0.190 B	3RT19 45-5AG62	0.190				
	--	200	220	--	C	3RT19 45-5AN61	0.190 B	3RT19 45-5AN62	0.190				
	--	400	440	--	B	3RT19 45-5AR61	0.190 B	3RT19 45-5AR62	0.190				
Solenoid coils · DC operation													
S2	3RT10 3., 3RT13 3., 3RT15 3.	--	--	--	24	B	3RT19 34-5BB41	0.650 B	3RT19 34-5BB42	0.650			
		--	--	--	42	B	3RT19 34-5BD41	0.650 C	3RT19 34-5BD42	0.650			
		--	--	--	48	B	3RT19 34-5BW41	0.650 B	3RT19 34-5BW42	0.650			
		--	--	--	60	B	3RT19 34-5BE41	0.650 B	3RT19 34-5BE42	0.650			
		--	--	--	110	B	3RT19 34-5BF41	0.650 B	3RT19 34-5BF42	0.650			
		--	--	--	125	B	3RT19 34-5BG41	0.650 C	3RT19 34-5BG42	0.650			
		--	--	--	220	B	3RT19 34-5BM41	0.650 B	3RT19 34-5BM42	0.650			
		--	--	--	230	B	3RT19 34-5BP41	0.650 B	3RT19 34-5BP42	0.650			
	S3	3RT10 4., 3RT13 4., 3RT14 4., 3RT15 4.	--	--	--	24	B	3RT19 44-5BB41	1.000 B	3RT19 44-5BB42	1.000		
			--	--	--	42	C	3RT19 44-5BD41	1.000 B	3RT19 44-5BD42	1.000		
			--	--	--	48	B	3RT19 44-5BW41	1.000 B	3RT19 44-5BW42	1.000		
			--	--	--	60	B	3RT19 44-5BE41	1.000 B	3RT19 44-5BE42	1.000		
		--	--	--	110	B	3RT19 44-5BF41	1.000 B	3RT19 44-5BF42	1.000			
		--	--	--	125	B	3RT19 44-5BG41	1.000 B	3RT19 44-5BG42	1.000			
		--	--	--	220	B	3RT19 44-5BM41	1.000 B	3RT19 44-5BM42	1.000			
		--	--	--	230	B	3RT19 44-5BP41	1.000 B	3RT19 44-5BP42	1.000			

* You can order this quantity or a multiple thereof.

Accessories and Spare Parts



For 3RT, 3RH Contactors and Contactor Relays

Spare parts for 3RT, 3RH contactors and contactor relays

PU (UNIT, SET, M) = 1
 PS* = 1 unit
 PG = 101



3RT19 55-5A...

For contactors			Rated control supply voltage U_s min ... U_s max	DT	Screw terminals 	Weight per PU approx.	DT	Cage Clamp terminals 	Weight per PU approx.	
Size	Type	V AC/DC			Order No.	Price per PU	kg	Order No.	Price per PU	kg
Withdrawable coils										
<i>Conventional operating mechanism</i>										
S6	3RT10 5, 3RT14 5	23 ... 26	B	3RT19 55-5AB31	0.650 B	3RT19 55-5AB32	0.650			
		42 ... 48	B	3RT19 55-5AD31	0.650 B	3RT19 55-5AD32	0.650			
		110 ... 127	B	3RT19 55-5AF31	0.650 B	3RT19 55-5AF32	0.650			
		200 ... 220	B	3RT19 55-5AM31	0.650 B	3RT19 55-5AM32	0.650			
		220 ... 240	B	3RT19 55-5AP31	0.650 B	3RT19 55-5AP32	0.650			
		240 ... 277	B	3RT19 55-5AU31	0.650 B	3RT19 55-5AU32	0.650			
		380 ... 420	B	3RT19 55-5AV31	0.650 B	3RT19 55-5AV32	0.650			
		440 ... 480	B	3RT19 55-5AR31	0.650 B	3RT19 55-5AR32	0.650			
		500 ... 550	B	3RT19 55-5AS31	0.650 B	3RT19 55-5AS32	0.650			
		575 ... 600	B	3RT19 55-5AT31	0.650 B	3RT19 55-5AT32	0.650			
S10	3RT10 6, 3RT14 6	23 ... 26	B	3RT19 65-5AB31	0.850 B	3RT19 65-5AB32	0.850			
		42 ... 48	B	3RT19 65-5AD31	0.850 B	3RT19 65-5AD32	0.850			
		110 ... 127	B	3RT19 65-5AF31	0.850 B	3RT19 65-5AF32	0.850			
		200 ... 220	C	3RT19 65-5AM31	0.850 B	3RT19 65-5AM32	0.850			
		220 ... 240	B	3RT19 65-5AP31	0.850 B	3RT19 65-5AP32	0.850			
		240 ... 277	B	3RT19 65-5AU31	0.850 B	3RT19 65-5AU32	0.850			
		380 ... 420	B	3RT19 65-5AV31	0.850 B	3RT19 65-5AV32	0.850			
		440 ... 480	B	3RT19 65-5AR31	0.850 B	3RT19 65-5AR32	0.850			
		500 ... 550	C	3RT19 65-5AS31	0.850 B	3RT19 65-5AS32	0.850			
		575 ... 600	C	3RT19 65-5AT31	0.850 B	3RT19 65-5AT32	0.850			
S10	3RT12 6 vacuum contactors	23 ... 26	B	3RT19 66-5AB31	1.000	--				
		42 ... 48	B	3RT19 66-5AD31	1.000	--				
		110 ... 127	A	3RT19 66-5AF31	1.000	--				
		200 ... 220	C	3RT19 66-5AM31	1.000	--				
		220 ... 240	A	3RT19 66-5AP31	1.000	--				
		240 ... 277	C	3RT19 66-5AU31	1.000	--				
		380 ... 420	B	3RT19 66-5AV31	1.000	--				
		440 ... 480	C	3RT19 66-5AR31	1.000	--				
		500 ... 550	C	3RT19 66-5AS31	1.000	--				
		575 ... 600	C	3RT19 66-5AT31	1.000	--				
S12	3RT10 7, 3RT14 7, 3RT12 7 vacuum contactors	23 ... 26	B	3RT19 75-5AB31	1.300 B	3RT19 75-5AB32	1.300			
		42 ... 48	B	3RT19 75-5AD31	1.300 B	3RT19 75-5AD32	1.300			
		110 ... 127	B	3RT19 75-5AF31	1.300 B	3RT19 75-5AF32	1.300			
		200 ... 220	C	3RT19 75-5AM31	1.300 B	3RT19 75-5AM32	1.300			
		220 ... 240	B	3RT19 75-5AP31	1.300 B	3RT19 75-5AP32	1.300			
		240 ... 277	B	3RT19 75-5AU31	1.300 B	3RT19 75-5AU32	1.300			
		380 ... 420	B	3RT19 75-5AV31	1.300 B	3RT19 75-5AV32	1.300			
		440 ... 480	B	3RT19 75-5AR31	1.300 B	3RT19 75-5AR32	1.300			
		500 ... 550	C	3RT19 75-5AS31	1.300 B	3RT19 75-5AS32	1.300			
		575 ... 600	C	3RT19 75-5AT31	1.300 B	3RT19 75-5AT32	1.300			

* You can order this quantity or a multiple thereof.

Accessories and Spare Parts



For 3RT, 3RH Contactors and Contactor Relays

Spare parts for 3RT, 3RH
contactors and contactor relays

PU (UNIT, SET, M) = 1
PS* = 1 unit
PG = 101



3RT19 55-5N...

For contactors			Rated control supply voltage U_s	DT	Screw terminals 	Weight per PU approx.	DT	Cage Clamp terminals 	Weight per PU approx.
Size	Type	V AC/DC	Order No.	Price per PU	kg	Order No.	Price per PU	kg	

Withdrawable coils

Solid-state operating mechanisms

For 24 V DC PLC output

S6	3RT10 5,	21 ... 27.3	C	3RT19 55-5NB31	0.650 B	3RT19 55-5NB32	0.650
	3RT14 5	96 ... 127	B	3RT19 55-5NF31	0.650 B	3RT19 55-5NF32	0.650
		200 ... 277	B	3RT19 55-5NP31	0.650 B	3RT19 55-5NP32	0.650
S10	3RT10 6,	21 ... 27.3	B	3RT19 65-5NB31	0.900 B	3RT19 65-5NB32	0.900
	3RT14 6	96 ... 127	B	3RT19 65-5NF31	0.900 B	3RT19 65-5NF32	0.900
		200 ... 277	B	3RT19 65-5NP31	0.900 B	3RT19 65-5NP32	0.900
	3RT12 6 vacuum contactors	21 ... 27.3 96 ... 127 200 ... 277	B C C	3RT19 66-5NB31 3RT19 66-5NF31 3RT19 66-5NP31	0.650 0.650 0.650	-- -- --	
S12	3RT10 7,	21 ... 27.3	B	3RT19 75-5NB31	1.100 B	3RT19 75-5NB32	1.100
	3RT14 7,	96 ... 127	B	3RT19 75-5NF31	1.100 B	3RT19 75-5NF32	1.100
	3RT12 7 vacuum contactors	200 ... 277	B	3RT19 75-5NP31	1.100 B	3RT19 75-5NP32	1.100

For 24 V DC PLC output/PLC relay output, with remaining lifetime indicator (RLT)

(Withdrawable coil with lateral solid-state module)

S6	3RT10 5,	96 ... 127	B	3RT19 55-5PF31	0.650	--	
	3RT14 5	200 ... 277	B	3RT19 55-5PP31	0.650	--	
S10	3RT10 6,	96 ... 127	B	3RT19 65-5PF31	1.300	--	
	3RT14 6	200 ... 277	B	3RT19 65-5PP31	1.300	--	
S12	3RT10 7,	96 ... 127	B	3RT19 75-5PF31	1.300	--	
	3RT14 7	200 ... 277	B	3RT19 75-5PP31	1.300	--	

With AS-Interface and remaining lifetime indicator (RLT)

(Withdrawable coil with lateral solid-state module)

S6	3RT10 5,	96 ... 127	B	3RT19 55-5QF31	0.650	--	
	3RT14 5	200 ... 277	B	3RT19 55-5QP31	0.650	--	
S10	3RT10 6,	96 ... 127	B	3RT19 65-5QF31	1.300	--	
	3RT14 6	200 ... 277	B	3RT19 65-5QP31	1.300	--	
S12	3RT10 7,	96 ... 127	B	3RT19 75-5QF31	1.300	--	
	3RT14 7	200 ... 277	B	3RT19 75-5QP31	1.300	--	

Accessories and Spare Parts

For 3RT, 3RH Contactors and Contactor Relays

Spare parts for 3RT, 3RH contactors and contactor relays

For contactors		Version	DT	Order No.	Price per PU	PU (UNIT, SET, M)	PS*	PG	Weight per PU approx. kg
Size	Type								
Arc chutes									
S2	3RT10 3.	Arc chutes, 3-pole	C	3RT19 36-7A		1	1 unit	101	0.110
S3	3RT10 4., 3RT14 46		C	3RT19 46-7A		1	1 unit	101	0.300
S6	3RT10 54 3RT10 55 3RT10 56		B	3RT19 54-7A		1	1 unit	101	0.760
			B	3RT19 55-7A		1	1 unit	101	0.760
			B	3RT19 56-7A		1	1 unit	101	0.760
S10	3RT10 64 3RT10 65 3RT10 66		B	3RT19 64-7A		1	1 unit	101	1.350
			B	3RT19 65-7A		1	1 unit	101	1.350
			B	3RT19 66-7A		1	1 unit	101	1.350
S12	3RT10 75 3RT10 76		B	3RT19 75-7A		1	1 unit	101	1.650
			B	3RT19 76-7A		1	1 unit	101	1.650
S6	3RT14 56		B	3RT19 56-7B		1	1 unit	101	0.720
S10	3RT14 66		B	3RT19 66-7B		1	1 unit	101	1.350
S12	3RT14 76		B	3RT19 76-7B		1	1 unit	101	1.400
Contacts with fixing parts									
<i>For contactors with 3 main contacts</i>									
S2	3RT10 34 3RT10 35 3RT10 36	Main contacts (3 NO contacts) for utilization category AC-3 (1 set = 3 movable and 6 fixed switching elements with fixing parts)	▶	3RT19 34-6A		1	1 unit	101	0.050
			▶	3RT19 35-6A		1	1 unit	101	0.050
			▶	3RT19 36-6A		1	1 unit	101	0.050
S3	3RT10 44 3RT10 45 3RT10 46		▶	3RT19 44-6A		1	1 unit	101	0.110
			▶	3RT19 45-6A		1	1 unit	101	0.110
			▶	3RT19 46-6A		1	1 unit	101	0.110
S6	3RT10 54 3RT10 55 3RT10 56		▶	3RT19 54-6A		1	1 unit	101	0.280
			▶	3RT19 55-6A		1	1 unit	101	0.280
			▶	3RT19 56-6A		1	1 unit	101	0.280
S10	3RT10 64 3RT10 65 3RT10 66		▶	3RT19 64-6A		1	1 unit	101	0.550
			▶	3RT19 65-6A		1	1 unit	101	0.550
			▶	3RT19 66-6A		1	1 unit	101	0.550
S12	3RT10 75 3RT10 76		▶	3RT19 75-6A		1	1 unit	101	0.900
			A	3RT19 76-6A		1	1 unit	101	0.100
S3	3RT14 46	Main contacts (3 NO contacts) for utilization category AC-1 (1 set = 3 movable and 6 fixed switching elements with fixing parts)	B	3RT19 46-6D		1	1 unit	101	0.900
S6	3RT14 56		B	3RT19 56-6D		1	1 unit	101	0.280
S10	3RT14 66		B	3RT19 66-6D		1	1 unit	101	0.550
S12	3RT14 76		A	3RT19 76-6D		1	1 unit	101	0.900
<i>For 3RT12 vacuum contactors</i>									
S10	3RT12 64 3RT12 65 3RT12 66	3 vacuum interrupters with fixing parts	B	3RT19 64-6V		1	1 unit	101	1.530
			B	3RT19 65-6V		1	1 unit	101	1.530
			B	3RT19 66-6V		1	1 unit	101	1.530
S12	3RT12 75 3RT12 76		B	3RT19 75-6V		1	1 unit	101	1.780
			B	3RT19 76-6V		1	1 unit	101	1.780
<i>For contactors with 4 main contacts</i>									
S2	3RT13 36	Main contacts (4 NO contacts) for utilization category AC-1 (1 set = 4 movable and 8 fixed switching elements with fixing parts)	C	3RT19 36-6E		1	1 unit	101	0.060
S3	3RT13 44 3RT13 46		C	3RT19 44-6E		1	1 unit	101	0.150
			C	3RT19 46-6E		1	1 unit	101	0.150









* You can order this quantity or a multiple thereof.

Accessories and Spare Parts

For 3T Contactors and Contactor Relays

Accessories for 3TB, 3TC, 3TF, 3TG, 3TK contactors

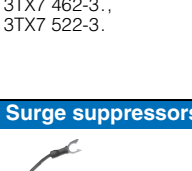
Selection and ordering data

For contactors		Version	Rated control supply voltage U_s		DT	Order No.	Price per PU	PU (UNIT, SET, M)	PS*	PG	Weight per PU approx. kg			
Size	Type		V AC	V DC										
Surge suppressors¹⁾ · Varistors														
	2	3TC44 ²⁾	Varistors³⁾ With line spacer, for mounting onto the coil terminal	24 ... 48	24 ... 70	A	3TX7 402-3G		1	1 unit	101	0.015		
				48 ... 127	70 ... 150	A	3TX7 402-3H		1	1 unit	101	0.015		
				127 ... 240	150 ... 250	A	3TX7 402-3J		1	1 unit	101	0.015		
				240 ... 400	--	C	3TX7 402-3K		1	1 unit	101	0.025		
				400 ... 600	--	C	3TX7 402-3L		1	1 unit	101	0.025		
	4 and 6	3TB50 and 3TC56	Varistors³⁾ For sticking onto the contactor base or for mounting separately	24 ... 48	24 ... 70	D	3TX7 462-3G		1	1 unit	101	0.020		
				48 ... 127	70 ... 150	C	3TX7 462-3H		1	1 unit	101	0.020		
				127 ... 240	150 ... 250	B	3TX7 462-3J		1	1 unit	101	0.020		
				240 ... 400	--	A	3TX7 462-3K		1	1 unit	101	0.020		
				400 ... 600	--	C	3TX7 462-3L		1	1 unit	101	0.020		
	8 and 12	3TC52 and 3TC56	Varistors For sticking onto the contactor base or for mounting separately	24 ... 48	--	D	3TX7 462-3G		1	1 unit	101	0.020		
				48 ... 127	--	C	3TX7 462-3H		1	1 unit	101	0.020		
				127 ... 240	--	B	3TX7 462-3J		1	1 unit	101	0.020		
				240 ... 400	--	A	3TX7 462-3K		1	1 unit	101	0.020		
				400 ... 600	--	C	3TX7 462-3L		1	1 unit	101	0.020		
	8 ... 12	3TB52 ... 3TB56, 3TC52 and 3TC56	Varistors³⁾ For separate screw connection or snapping onto 35 mm standard mounting rail	--	24 ... 70	B	3TX7 522-3G		1	1 unit	101	0.080		
				--	70 ... 150	B	3TX7 522-3H		1	1 unit	101	0.080		
				--	150 ... 250	B	3TX7 522-3J		1	1 unit	101	0.080		
	14	3TF68 and 3TF69	Varistors³⁾ For DC economy circuit; for snapping onto the side of auxiliary switches	--	24 ... 48	C	3TX7 572-3G		1	1 unit	101	0.080		
				--	48 ... 127	C	3TX7 572-3H		1	1 unit	101	0.080		
				--	127 ... 240	C	3TX7 572-3J		1	1 unit	101	0.080		
Surge suppressors · RC elements														
	4	3TC48	RC elements For lateral snapping onto auxiliary switch or 35 mm standard mounting rail	24 ... 48	--	C	3TX7 462-3R		1	1 unit	101	0.090		
				--	24 ... 70	B	3TX7 522-3R		1	1 unit	101	0.090		
				48 ... 127	--	A	3TX7 462-3S		1	1 unit	101	0.090		
				--	70 ... 150	B	3TX7 522-3S		1	1 unit	101	0.090		
				127 ... 240	--	A	3TX7 462-3T		1	1 unit	101	0.090		
				--	150 ... 250	B	3TX7 522-3T		1	1 unit	101	0.090		
				240 ... 400	--	A	3TX7 462-3U		1	1 unit	101	0.090		
400 ... 600	--	C	3TX7 462-3V		1	1 unit	101	0.090						
	6 ... 12	3TB50, 3TC52 and 3TC56	RC elements For lateral snapping onto auxiliary switch or 35 mm standard mounting rail	24 ... 48	--	B	3TX7 522-3R		1	1 unit	101	0.090		
				48 ... 127	--	B	3TX7 522-3S		1	1 unit	101	0.090		
				127 ... 240	--	B	3TX7 522-3T		1	1 unit	101	0.090		
				240 ... 400	--	B	3TX7 522-3U		1	1 unit	101	0.090		
				400 ... 600	--	B	3TX7 522-3V		1	1 unit	101	0.090		
Surge suppressors⁴⁾ · Diodes														
	6 ... 12	3TB50 ... 3TB56, 3TC48 ... 3TC56	Diode assemblies (diode and Zener diode) For DC solenoid system, for sticking onto the contactor base or for mounting separately	--	24 ... 250	D	3TX7 462-3D		1	1 unit	101	0.015		

¹⁾ The surge suppressor is included in the scope of supply of the following contactors: 3TF68 and 3TF69 (AC operation): varistor circuit.

²⁾ The connection piece for mounting the surge suppressor must be bent slightly.



³⁾ Includes the peak value of the alternating voltage on the DC side.

⁴⁾ Not for DC economy circuit.

Accessories and Spare Parts

For 3T Contactors and Contactor Relays

Accessories for 3TB, 3TC, 3TF, 3TG, 3TK contactors

For contactors	Version	DT	Order No.	Price per PU	PU (UNIT, SET, M)	PS*	PG	Weight per PU approx. kg
Size	Type							
Solid-state compatible auxiliary switch blocks with screw terminals								
	14 2 and 4	3TF68 and 3TF69 3TC44... 3TC48	For mounting onto the side of contactors For use in dusty atmosphere and solid-state circuits with rated operational currents I_e AC-14 and DC-13 from 1 mA to 300 mA at 3 V to 60 V With 1 changeover contact 2nd auxiliary switch block, left or right (replacement for 3TY6 561-1U, 3TY6 561-1V)	▶	3TY7 561-1UA00	1	1 unit	101 0.060
5TY7 561-1.								
Coupling links for control by PLC								
	14	3TF68 and 3TF69	Operating range: 17 to 30 V DC. Power consumption: 0.5 W at 24 V DC. Fitted with varistor. For technical specifications see Technical Information LV 1 T For snapping onto the side of auxiliary switch, with surge suppression	▶	3TX7 090-0D	1	1 unit	101 0.080
Terminal covers for protection against inadvertent contact with exposed busbar connections								
	14	3TF68 3TF69	For screwing onto free screw end on middle connecting bar. 2 units required per contactor. (1 set = 2 units)	B	3TX7 686-0A	1	1 unit	101 0.410
3TX7 6.6-0A				B	3TX7 696-0A	1	1 unit	101 0.410
	6 8 and SIRIUS S6 10 and 14 and SIRIUS S10, S12	3TB50, 3TC48 3TB52 3RT1. 5 3TB54... 3TB56, 3TC52, 3TC56, 3RT1. 6 3RT1. 7	Can be screwed on free screw end. Covers one busbar connection (1 set = 6 units).	M6 B M8 B M10 B	3TX6 506-3B 3TX6 526-3B 3TX6 546-3B	1 1 1	1 unit 1 unit 1 unit	101 0.100 101 0.140 101 0.260
3TX6 526-3B								
Links for paralleling (star jumpers) · 3-pole, without connection terminal¹⁾								
	14	3TF68		C	3TX7 680-0D	1	1 unit	101 0.250
			Cover plates for links for paralleling					
	14	3TF68	A cover plate must be used in order to protect against inadvertent contact with exposed busbar connections (EN 50274).	C	3TX7 680-0E	1	1 unit	101 0.080
Box terminals for laminated copper bars								
			Without auxiliary conductor connection (1 set = 3 units)					
	14	3TF68	With single covers for protection against inadvertent contact (EN 50274)	C	3TX7 570-1E	1	1 unit	101 0.780
			With auxiliary conductor connection (1 set = 3 units)					
	14	3TF69	Conductor cross-sections for auxiliary conductors: Solid wire 2 x (0.75 ... 2.5) mm ² Finely stranded with end sleeve 2 x (0.5 ... 2.5) mm ² Solid or stranded 2 x (18 ... 12) AWG Tightening torque 0.8 ... 1.4 Nm (7 ... 12 lb.in)	C	3TX7 690-1F	1	1 unit	101 2.000

¹⁾ The link for paralleling can be reduced by one pole.

Accessories and Spare Parts

For 3T Contactors and Contactor Relays

Accessories for 3TB, 3TC, 3TF, 3TG, 3TK contactors

For contactors		Remarks	Rated control supply voltage U_s	DT	Order No.	Price per PU	PU (UNIT, SET, M)	PS*	PG	Weight per PU approx. kg
Size	Type									
Arc chutes										
2	3TC44 17-0L..	With cutout for mounting resistor		B	3TY2 442-0B		1	1 unit	101	0.160
Solenoid coils										
2	3TC44	With series resistor Without varistor	24 110	C	3TY6 443-0LB4 3TY6 443-0LF4		1	1 unit	101	0.400
4	3TC48		24 110	C	3TY6 483-0LB4 3TY6 483-0LF4		1	1 unit	101	1.100
6	3TB50		24 110	C	3TY6 503-0LB4 3TY6 503-0LF4		1	1 unit	101	1.100
8	3TB52 and 3TC52		24 110	D	3TY6 523-0LB4 3TY6 523-0LF4		1	1 unit	101	1.100
10	3TB54		24 110	C	3TY6 543-0LB4 3TY6 543-0LF4		1	1 unit	101	1.100
12	3TB56 and 3TC56		24 110	C	3TY6 563-0LB4 3TY6 563-0LF4		1	1 unit	101	1.100

All spare parts not mentioned above are identical to those for the standard contactors.

Auxiliary contacts	Rated operational current $I_e/AC-15/AC-14$ at			Auxiliary contacts		DT	Order No.	Price per PU	PU (UNIT, SET, M)	PS*	PG	Weight per PU approx. kg
	230/220 V	400/380 V	500 V	Ident. No.	Version							
Number	A	A	A	NO	NC	NO	NC					

Snap-on auxiliary switch blocks for 3TF2 contactors with screw terminals



3TX4 4...-A

For assembling contactors with several auxiliary contacts with 2, 4 and 5 auxiliary contacts according to DIN 50012 for 3TF2. 10 contactors (auxiliary contact 1 NO = 10E)

1	4	3	2	11E	--	1	--	--	▶	3TX4 401-1A	1	1 unit	101	0.050
3	4	3	2	22E	1	2	--	--	▶	3TX4 412-1A	1	1 unit	101	0.050
4	4	3	2	23E	1	3	--	--	▶	3TX4 413-1A	1	1 unit	101	0.050
				32E	2	2	--	--	▶	3TX4 422-1A	1	1 unit	101	0.050
With 3 and 5 auxiliary contacts according to DIN 50005 for 3TF2 contactors														
2	4	3	2	20	2	--	--	--	▶	3TX4 420-2A	1	1 unit	101	0.050
				11	1	1	--	--	▶	3TX4 411-2A	1	1 unit	101	0.050
				02	--	2	--	--	▶	3TX4 402-2A	1	1 unit	101	0.050
				11; U	--	--	1	1	D	3TX4 411-2G	1	1 unit	101	0.050
4	4	3	2	40	4	--	--	--	▶	3TX4 440-2A	1	1 unit	101	0.050
				31	3	1	--	--	▶	3TX4 431-2A	1	1 unit	101	0.050
				22	2	2	--	--	▶	3TX4 422-2A	1	1 unit	101	0.050
				22; 2 U	--	--	2	2	D	3TX4 422-2G	1	1 unit	101	0.050

For contactor	Rated control supply voltage U_s	Time setting range (minimum times)	DT	Order No.	Price per PU	PU (UNIT, SET, M)	PS*	PG	Weight per PU approx. kg
Type									

OFF-delay devices for 3TF2 contactors with screw terminals



3TX4 490-1H

For DC-operated contactors for bridging short-time power failures up to 0.8 s

3TF2. ...0BB4	24 V DC	0.25 s or 0.5 s	A	3TX4 490-1H		1	1 unit	101	0.085
---------------	---------	-----------------	---	--------------------	--	---	--------	-----	-------

Accessories and Spare Parts

For 3T Contactors and Contactor Relays

Accessories for 3TB, 3TC, 3TF, 3TG, 3TK contactors

For contactors	Rated control supply voltage U_s		Power consumption of LED at U_s	DT	Order No.	Price per PU	PU (UNIT, SET, M)	PS*	PG	Weight per PU approx. kg
	V AC	V DC								

Surge suppressors for 3TF2 contactors for plugging onto contactors with and without auxiliary switch blocks



3TX4 490-3A

Version without LED

RC elements

3TF2. ...-0...	24 ... 48	24 ... 70	--	B	3TX4 490-3R	1	1 unit	101	0.010
3TF2. ...-1...	48 ... 127	70 ... 150	--	B	3TX4 490-3S	1	1 unit	101	0.010
	127 ... 240	150 ... 250	--	B	3TX4 490-3T	1	1 unit	101	0.010
	240 ... 400	--	--	B	3TX4 490-3U	1	1 unit	101	0.015
	400 ... 600	--	--	B	3TX4 490-3V	1	1 unit	101	0.015

Varistors

3TF2. ...-0...	≤ 48	24 ... 70	--	B	3TX4 490-3G	1	1 unit	101	0.010
3TF2. ...-1...	48 ... 127	70 ... 150	--	B	3TX4 490-3H	1	1 unit	101	0.010
	127 ... 240	150 ... 250	--	B	3TX4 490-3J	1	1 unit	101	0.010
	240 ... 400	--	--	B	3TX4 490-3K	1	10 units	101	0.015
	400 ... 600	--	--	B	3TX4 490-3L	1	10 units	101	0.015

Noise suppression diodes

3TF2. ...-0...	--	12 ... 250	--	B	3TX4 490-3A	1	1 unit	101	0.010
3TF2. ...-1...									

Diode assemblies (diode and Zener diode)

For DC operation and short break times

3TF2. ...-0...	--	24 ... 250	--	B	3TX4 490-3B	1	1 unit	101	0.010
3TF2. ...-1...									



3TX4 490-4G

Version with LED

Varistors

3TF2. ...-0...	24 ... 48	12 ... 24	10 ... 120	B	3TX4 490-4G	1	1 unit	101	0.010
3TF2. ...-1...	48 ... 127	24 ... 70	20 ... 470	B	3TX4 490-4H	1	1 unit	101	0.010
	127 ... 240	70 ... 150	50 ... 700	B	3TX4 490-4J	1	1 unit	101	0.010
	--	150 ... 250	160 ... 950	B	3TX4 490-4K	1	1 unit	101	0.010

Noise suppression diodes

3TF2. ...-0...	--	24 ... 70	20 ... 470	B	3TX4 490-4A	1	1 unit	101	0.010
3TF2. ...-1...	--	70 ... 150	50 ... 700	B	3TX4 490-4B	1	1 unit	101	0.010
	--	150 ... 250	160 ... 950	B	3TX4 490-4C	1	1 unit	101	0.010

Additional load modules for 3TF2 contactors for plugging onto contactors with and without auxiliary switch blocks¹⁾

For increasing the permissible residual current and for limiting the residual voltage

3TF2. ...-0A...	230/220, 50 Hz	--	B	3TX4 490-1J	1	1 unit	101	0.010
3TF2. ...-1A...	230, 60 Hz							
	230, 50/60 Hz							
	Operating range 0.8 ... 1.1 x U_s							

Plug-in bases with solder pin connections for printed circuit boards, width 45 mm for 3TF2 and 3TK2 contactors

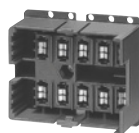

3TX4 491-2A

For 3TF2 and 3TK2 contactors
With flat connectors 6.3 mm x 0.8 mm;
Rated insulation voltage U_i : 400 V (degree of pollution 3);
Rated impulse withstand voltage U_{imp} : 6 kV;
Rated operational current I_e : 6 A;
Ⓢ and Ⓜ rated data: max. 300 V, 6 A

3TF20 ...-3...				A	3TX4 491-2A	1	5 units	101	0.030
3TF20 ...-7...									
3TK20 ...-3...									
3TK20 ...-7...									

Release tools

3TF2. ...-7...	For releasing contactors from 3TK20 ...-7...		D	3TX4 491-2K	1	1 unit	101	0.010
	3TX4 491-2A plug-in bases							

¹⁾ Dimensions as for 3TX4 490-3 surge suppressor.

Accessories and Spare Parts

For 3T Contactors and Contactor Relays

Accessories for 3TB, 3TC, 3TF, 3TG, 3TK
contactors

Accessories

For contactors	Max. rated operational currents I_e /AC-1 of the contactors at 55 °C	Max. conductor cross-sections	DT	Order No.	Price per PU	PU (UNIT, SET, M)	PS*	PG	Weight per PU approx. kg
Type	A	mm ²							
Links for paralleling (star jumpers)									
3-pole, without connection terminals^{1) 2)}									
3TG10	16 star jumpers can be reduced by one pole	--	▶	3RT19 16-4BA31		1	1 unit	101	0.010
3-pole, with connection terminals^{1) 3)}									
3TG10	40	25	▶	3RT19 16-4BB31		1	1 unit	101	0.015
4-pole, with connection terminals^{1) 4)}									
3TG10	50	25	C	3RT19 16-4BB41		1	1 unit	101	0.015

¹⁾ The links for paralleling can be reduced by one pole. The rated operational currents apply to each pole. The links for paralleling are insulated.

²⁾ Replacement for 3TX4 490-2C.

³⁾ Replacement for 3TX4 490-2A.

⁴⁾ Replacement for 3TX4 490-2B.

Accessories and Spare Parts

For 3T Contactors and Contactor Relays

Accessories for 3TH contactor relays

Selection and ordering data

Version	Rated control supply voltage U_s		DT	Order No.	Price per PU	PU (UNIT, SET, M)	PS*	PG	Weight per PU approx.
	AC	DC							kg
	V	V							

Surge suppressors¹⁾ for 3TH4 contactor relays



3TX7 402-3.

Noise suppression diodes With line spacer, for mounting onto the coil terminal	--	24 ... 250	A	3TX7 402-3A		1	1 unit	101	0.015
Diode assemblies (diode and Zener diode) with line spacer, DC operation, for mounting onto the coil terminal	--	24 ... 250	A	3TX7 402-3D		1	1 unit	101	0.015
Varistors²⁾ With line spacer, for mounting onto the coil terminal	24 ... 48	24 ... 70	A	3TX7 402-3G		1	1 unit	101	0.015
	48 ... 127	70 ... 150	A	3TX7 402-3H		1	1 unit	101	0.015
	127 ... 240	150 ... 250	A	3TX7 402-3J		1	1 unit	101	0.015
	240 ... 400	--	C	3TX7 402-3K		1	1 unit	101	0.025
	400 ... 600	--	C	3TX7 402-3L		1	1 unit	101	0.025
RC elements With line spacer, for mounting onto the coil terminal	24 ... 48	24 ... 70	A	3TX7 402-3R		1	1 unit	101	0.025
	48 ... 127	70 ... 150	A	3TX7 402-3S		1	1 unit	101	0.025
	127 ... 240	150 ... 250	A	3TX7 402-3T		1	1 unit	101	0.025
	240 ... 400	--	C	3TX7 402-3U		1	1 unit	101	0.025
	400 ... 600	--	C	3TX7 402-3V		1	1 unit	101	0.025
Covers For switch position indicator	--	--	B	3TX4 210-0P		1	1 unit	101	0.010

Coupling links for control by PLC for 3TH4 contactor relays

3TX4 090
mounted to contactor

Operating range: 17 to 30 V DC Power consumption: 0.5 W at 24 V DC For mounting directly to contactor coil without surge suppressor			A	3TX4 090-0C		1	1 unit	101	0.060
For mounting directly to contactor coil with surge suppressor			A	3TX4 090-0D		1	1 unit	101	0.060

¹⁾ The OFF-delay of the NO contact and the ON-delay of the NC contact are increased if the contactor coils are attenuated against voltage peaks (noise suppression diode 6 to 10 times; diode assemblies 2 to 6 times, varistor +2 to 5 ms).

²⁾ Includes the peak value of the alternating voltage on the DC side.

For contactors	Version	Rated control supply voltage U_s AC 50/60 Hz	Time setting range (minimum times)	DT	Order No.	Price per PU	PU (UNIT, SET, M)	PS*	PG	Weight per PU approx.
Type		V	s							kg

ON-delay devices

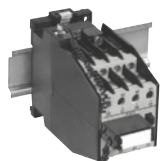



3TX4 180-0A

3TH42/ 3TH43	NTC thermistors Time tolerance + 100 %, -50 %	220 ... 230	0.1	B	3TX4 180-0A		1	1 unit	101	0.015
-----------------	--	-------------	-----	---	--------------------	--	---	--------	-----	-------

Accessories and Spare Parts

For 3T Contactors and Contactor Relays

Accessories for 3TH contactor relays

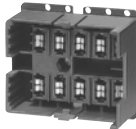
For contactors	Rated control supply voltage U_s		Power consumption of LED at U_s	DT	Order No.	Price per PU	PU (UNIT, SET, M)	PS*	PG	Weight per PU approx. kg	
	Type	V AC									V DC
Surge suppressors¹⁾											
for plugging onto contactors with and without auxiliary switch blocks											
<i>Version without LED</i>											
 3TX4 490-3A	RC elements										
	3TH2. ...-0...	24 ... 48	24 ... 70	--	B	3TX4 490-3R		1	1 unit	101	0.010
		48 ... 127	70 ... 150	--	B	3TX4 490-3S		1	1 unit	101	0.010
		127 ... 240	150 ... 250	--	B	3TX4 490-3T		1	1 unit	101	0.010
		240 ... 400	--	--	B	3TX4 490-3U		1	1 unit	101	0.015
		400 ... 600	--	--	B	3TX4 490-3V		1	1 unit	101	0.015
	Varistors										
	3TH2. ...-0...	≤ 48	24 ... 70	--	B	3TX4 490-3G		1	1 unit	101	0.010
		48 ... 127	70 ... 150	--	B	3TX4 490-3H		1	1 unit	101	0.010
		127 ... 240	150 ... 250	--	B	3TX4 490-3J		1	1 unit	101	0.010
	240 ... 400	--	--	B	3TX4 490-3K		1	10 units	101	0.015	
	400 ... 600	--	--	B	3TX4 490-3L		1	10 units	101	0.015	
Noise suppression diodes											
3TH2. ...-0...	--	12 ... 250	--	B	3TX4 490-3A		1	1 unit	101	0.010	
Diode assemblies (diode and Zener diode) For DC operation and short break times											
3TH2. ...-0...	--	24 ... 250	--	B	3TX4 490-3B		1	1 unit	101	0.010	
<i>Version with LED</i>											
 3TX4 490-4G	Varistors										
	3TH2. ...-0...	24 ... 48	12 ... 24	10 ... 12	B	3TX4 490-4G		1	1 unit	101	0.010
		48 ... 27	24 ... 70	20 ... 470	B	3TX4 490-4H		1	1 unit	101	0.010
		127 ... 240	70 ... 150	50 ... 700	B	3TX4 490-4J		1	1 unit	101	0.010
		--	150 ... 250	160 ... 950	B	3TX4 490-4K		1	1 unit	101	0.010
Noise suppression diodes											
3TH2. ...-0...	--	24 ... 70	20 ... 470	B	3TX4 490-4A		1	1 unit	101	0.010	
	--	70 ... 150	50 ... 700	B	3TX4 490-4B		1	1 unit	101	0.010	
	--	150 ... 250	160 ... 950	B	3TX4 490-4C		1	1 unit	101	0.010	
Additional load modules (residual current)											
for plugging onto contactors without and with auxiliary switch blocks											
 3TX4 490-1J	For increasing the permissible residual current and for limiting the residual voltage of SIMATIC semiconductor outputs										
	3TH2. ...-0A...	230/220, 50 Hz	--	--	B	3TX4 490-1J		1	1 unit	101	0.010
		230, 60 Hz	--	--							
		230, 50/60 Hz	--	--							
		Operating range 0.8 ... 1.1 x U_s									
Plug-in bases with solder pin connections for printed circuit boards, width 45 mm											
 3TX4 491-2A	For 3TH2 contactor relays; With flat connectors 1 x 6.3 mm ... 0.8 mm; Rated insulation voltage U_i : 400 V (degree of pollution 3); Rated impulse withstand voltage U_{imp} : 6 kV; Rated operational current I_g : 6 A; Ⓢ and ⓈA rated data: max. 300 V, 6 A										
	3TH20 ...-3...				A	3TX4 491-2A		1	5 units	101	0.030
	3TH20 ...-7...										





¹⁾ The OFF-delay of the NO contact and the ON-delay of the NC contact are increased if the contactor coils are attenuated against voltage peaks (noise suppression diode 6 to 10 times; diode assemblies 2 to 6 times, varistor +2 to 5 ms).

Accessories and Spare Parts

For 3T Contactors and Contactor Relays

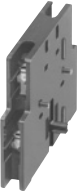
Spare parts for 3TB, 3TC, 3TF, 3TK contactors

Selection and ordering data

For contactors	Auxiliary contacts			Version	DT	Order No.	Price per PU	PU (UNIT, SET, M)	PS*	PG	Weight per PU approx.	
	Size	Type	NO NC NC									kg
Auxiliary switch blocks												
	6	3TB50	1	1	--	Auxiliary switch block, left or right (replacement for 3TY6 501-1A/-1B)	▶		1	1 unit	101	0.055
			1	--	1	Auxiliary switch block, right	▶		3TY6 501-1E	1	1 unit	101
	8 ... 12	3TB52 ... 3TB56	1	1	--	Auxiliary switch block, left	▶	3TY6 561-1A	1	1 unit	101	0.075
			1	1	--	Auxiliary switch block, right	▶	3TY6 561-1B	1	1 unit	101	0.075
			1	--	1	Auxiliary switch block, right	▶	3TY6 561-1E	1	1 unit	101	0.075
			1	--	1	Auxiliary switch block, right	▶	3TY6 561-1E	1	1 unit	101	0.075
Solenoid coils												
DC operation												
	6	3TB50	--	--	--		▶	3TY6 503-0B..		on request		
	8	3TB52					▶	3TY6 523-0B..		on request		
	10	3TB54					▶	3TY6 543-0B..		on request		
	12	3TB56					▶	3TY6 563-0B..		on request		
Arc chutes												
	6	3TB50	--	--	--	1 arc chute, 3-pole	▶	3TY6 502-0A	1	1 unit	101	0.750
	8	3TB52					▶	3TY6 522-0A	1	1 unit	101	1.200
	10	3TB54					▶	3TY6 542-0A	1	1 unit	101	1.500
	12	3TB56					▶	3TY6 562-0A	1	1 unit	101	1.600
Contacts with fixing parts												
In order to ensure reliable operation of the contactors, only original replacement contacts should be used.												
	6	3TB50	--	--	--	(1 set =	B	3TY6 500-0A	1	1 unit	101	0.280
	8	3TB52				3 moving and 6 fixed	B	3TY6 520-0A	1	1 unit	101	0.360
	10	3TB54				switching elements)	B	3TY6 540-0A	1	1 unit	101	0.530
	12	3TB56					B	3TY6 560-0A	1	1 unit	101	0.760

For rated control supply voltages for solenoid coils, see page 3/131.

Accessories and Spare Parts

For 3T Contactors and Contactor Relays

Spare parts for 3TB, 3TC, 3TF, 3TK contactors

For contactors	Auxiliary contacts	Version	DT	Order No.	Price per PU	PU (UNIT, SET, M)	PS*	PG	Weight per PU approx.
Size	Type	NO	NC						kg

Auxiliary switch blocks

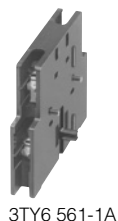

3TY6 561-1A

2 and 4	3TC44, 3TC48	1	1	Auxiliary switch block, left or right (replacement for 3TY6 501-1A/-1B)	▶	3TY6 501-1AA00	1	1 unit	101	0.055
4	3TC48	1	1	2nd auxiliary switch block, left ¹⁾	▶	3TY6 501-1K	1	1 unit	101	0.055
				2nd auxiliary switch block, right ¹⁾	D	3TY6 501-1L	1	1 unit	101	0.055
8 and 12	3TC52, 3TC56	1	1	Auxiliary switch block, left	▶	3TY6 561-1A	1	1 unit	101	0.075
				Auxiliary switch block, right	▶	3TY6 561-1B	1	1 unit	101	0.075
				2nd auxiliary switch block, left ¹⁾	▶	3TY6 561-1K	1	1 unit	101	0.075
				2nd auxiliary switch block, right ¹⁾	▶	3TY6 561-1L	1	1 unit	101	0.075

Contacts with fixing parts



3TY2 520-0A

In order to ensure reliable operation of the contactors, only **original replacement contacts** should be used.

2	3TC44	--	--	(1 set =	B	3TY2 440-0A	1	1 unit	101	0.070
4	3TC48			2 moving and 4 fixed	B	3TY2 480-0A	1	1 unit	101	0.100
8	3TC52			switching elements)	B	3TY2 520-0A	1	1 unit	101	0.250
12	3TC56				C	3TY2 560-0A	1	1 unit	101	0.450

For rated control supply voltages for solenoid coils, see page 3/131.

Arc chutes



3TC2 48

2	3TC44	--	--	1 arc chute,	C	3TY2 442-0A	1	1 unit	101	0.170
4	3TC48			2-pole	C	3TY2 482-0A	1	1 unit	101	0.500
8	3TC52				C	3TY2 522-0A	1	1 unit	101	1.200
12	3TC56				C	3TY2 562-0A	1	1 unit	101	2.130

Solenoid coils

DC operation

2	3TC44	--	--			3TY6 443-0B..		on request		
4	3TC48					3TY6 483-0B..		on request		
8	3TC52					3TY6 523-0B..		on request		
12	3TC56					3TY6 563-0B..		on request		

AC operation

2	3TC44	--	--			3TY7 403-0A..		on request		
4	3TC48					3TY6 483-0A..		on request		
8	3TC52					3TY6 523-0A..		on request		
12	3TC56					3TY6 566-0A..		on request		

¹⁾ Can only be mounted on AC-operated contactors.

Accessories and Spare Parts

For 3T Contactors and Contactor Relays

Spare parts for 3TB, 3TC, 3TF, 3TK contactors

For contactors	Version	Rated control supply voltage U_s	DT	Order No.	Price per PU	PU (UNIT, SET, M)	PS*	PG	Weight per PU approx.
Type		V AC/DC							kg

Varistors

3TC7	For sticking onto the contactor base	24 110	C C	3TX2 746-2F 3TX2 746-2G		1 1	1 unit 1 unit	101 101	0.150 0.150
------	--------------------------------------	-----------	--------	--	--	--------	------------------	------------	----------------

Contacts with fixing parts

3TC7	Main contacts (1 set) for 3TC78: 2 units required per contactor		C	3TY2 740-0E		1	1 unit	101	0.360
------	---	--	---	--------------------	--	---	--------	-----	-------

Auxiliary switch blocks

3TC74	4 NO + 4 NC		▶	3TY2 741-2J		1	1 unit	101	0.270
3TC78	Auxiliary switch block left, with 2 NO + 2 NC		▶	3TY2 781-2C		1	1 unit	101	0.190
	Auxiliary switch block right, with 2 NO + 2 NC		▶	3TY2 781-2D		1	1 unit	101	0.190

Arc chutes

3TC7	For 3TC78: 2 units required per contactor		C	3TY2 742-0C		1	1 unit	101	3.900
------	---	--	---	--------------------	--	---	--------	-----	-------

For contactors	Contacts Version	Version	DT	Order No.	Price per PU	PU (UNIT, SET, M)	PS*	PG	Weight per PU approx.
Size	Type	NO	NC	NC					kg



Auxiliary switch blocks

With screw terminals

	14	3TF68 and 3TF69	1	1	--	1st auxiliary switch block, left or right Replacement for: 3TY7 561-1A/ -1B.	▶	3TY7 561-1AA00	1	1 unit	101	0.050
			1	--	1	Auxiliary switch block, left or right	▶	3TY7 561-1EA00	1	1 unit	101	0.050
			1	1	--	2nd auxiliary switch block, left or right Replacement for: 3TY7 561-1K/ -1L.	▶	3TY7 561-1KA00	1	1 unit	101	0.050

3TY7 561-1.A00

For coil reconnection with DC economy circuit, with screw terminals

14	3TF68 and 3TF69	--	--	1	Auxiliary switch block	▶	3TY7 681-1G	1	1 unit	101	0.050
----	-----------------	----	----	---	------------------------	---	--------------------	---	--------	-----	-------

For contactor	Version	DT	Order No.	Price per PU	PU (UNIT, SET, M)	PS*	PG	Weight per PU approx.
Size	Type							kg

Solenoid coils

AC operation

14	3TF68 3TF69	The solenoid coils are fitted as standard with varistors against overvoltage. The coil is supplied with switch-on electronics.		3TY7 683-0C.. 3TY7 693-0C..		on request on request		
----	----------------	--	--	--	--	--------------------------	--	--

DC operation · DC economy circuit

14	3TF68 3TF69	Reversing contactors are required for size 14 contactors: Contactor type 3TF68 and 3TF69 Reversing contactor 3TC44 (70 mm wide, 85 mm high) The solenoid coils are supplied without reversing contactor.		3TY7 683-0D.. 3TY7 693-0D..		on request on request		
----	----------------	---	--	--	--	--------------------------	--	--

3TY7 6.3-0...

Vacuum interrupters

In order to ensure reliable operation of the contactors, only **original replacement interrupters** should be used.

14	3TF68 3TF69	3 vacuum interrupters with components	B C	3TY7 680-0B 3TY7 690-0B		1 1	1 unit 1 unit	101 101	3.490 3.640
----	----------------	---------------------------------------	--------	--	--	--------	------------------	------------	----------------

For rated control supply voltages for solenoid coils, see page 3/131.

For solid-state compatible auxiliary switch blocks, see page 3/120.

* You can order this quantity or a multiple thereof.

Accessories and Spare Parts

For 3T Contactors and Contactor Relays

Spare parts for 3TB, 3TC, 3TF, 3TK contactors

Version	Rated control supply voltage U_s	DT	Order No.	Price per PU	PU (UNIT, SET, M)	PS*	PG	Weight per PU approx. kg
V AC								
Reversing contactors (3TC44)								
Complete with resistor and 1 m connecting cable and plug-in connector for 3TF68 ...-Q, 3TF69 ...-	110 ... 120	D	3TY7 684-0QG7		1	1 unit	101	1.000
	220 ... 240	D	3TY7 684-0QL7		1	1 unit	101	1.000
	380 ... 420	D	3TY7 684-0QV7		1	1 unit	101	1.000
Solenoid coils for main contactor, with rectifier bridge								
For 3TF68 ...-Q	110 ... 120	D	3TY7 683-0QG7		1	1 unit	101	2.700
	220 ... 240	D	3TY7 683-0QL7		1	1 unit	101	1.500
	380 ... 420	D	3TY7 683-0QV7		1	1 unit	101	1.460
For 3TF69 ...-Q	110 ... 120	D	3TY7 693-0QG7		1	1 unit	101	0.650
	220 ... 240	D	3TY7 693-0QL7		1	1 unit	101	1.500
	380 ... 420	D	3TY7 693-0QV7		1	1 unit	101	1.500

For rated control supply voltages for solenoid coils, see page 3/131.

For solid-state compatible auxiliary switch blocks, see page 3/120.

For contactors	Version	Rated control supply voltage U_s	DT	Order No.	Price per PU	PU (UNIT, SET, M)	PS*	PG	Weight per PU approx. kg
Type		V AC							
Surge suppressors · RC elements									
3TK10 to 3TK13		24 ... 48	D	3TK19 30-0A		1	1 unit	101	0.050
		110 ... 415	B	3TK19 30-0B		1	1 unit	101	0.050
3TK14 to 3TK17		48 ... 110	C	3TK19 34-0C		1	1 unit	101	0.050
		220 ... 600	B	3TK19 34-0D		1	1 unit	101	0.050
Terminal covers									
3TK10, 3TK11	For mounting onto contactors		B	3TK19 40-0A		1	2 units	101	0.150
3TK12, 3TK13		B	3TK19 42-0A		1	2 units	101	0.150	
3TK14, 3TK15		B	3TK19 44-0A		1	2 units	101	0.200	
3TK17		B	3TK19 46-0A		1	2 units	101	0.200	
Auxiliary switch blocks									
3TK1	1st auxiliary switch block, left or right	1 NO + 1 NC	B	3TK19 10-3A		1	1 unit	101	0.050
		2nd auxiliary switch block, left or right	B	3TK19 10-3B		1	1 unit	101	0.050
Locking devices									
3TK10, 3TK11	For mechanical interlocking of 2 identical contactors, auxiliary contacts 2 NC		B	3TK19 20-0A		1	1 unit	101	0.140
3TK12, 3TK13		B	3TK19 22-0A		1	1 unit	101	0.140	
3TK14, 3TK15, 3TK17	Mechanical interlock, including mounting plate		B	3TK19 24-0A		1	1 unit	101	6.750
Arc chutes									
3TK10	1 arc chute, 4-pole		D	3TK19 50-0A		1	1 unit	101	0.650
3TK11		D	3TK19 51-0A		1	1 unit	101	0.650	
3TK12		D	3TK19 52-0A		1	1 unit	101	1.250	
3TK13		D	3TK19 53-0A		1	1 unit	101	1.250	
3TK14		D	3TK19 54-0A		1	1 unit	101	3.700	
3TK15		D	3TK19 55-0A		1	1 unit	101	3.700	
3TK17		D	3TK19 57-0A		1	1 unit	101	3.700	
Solenoid coils									
3TK10, 3TK11				3TK19 70-0A..		on request			
3TK12, 3TK13				3TK19 72-0A..		on request			
3TK14, 3TK15, 3TK17				3TK19 74-0A..		on request			
Contacts with fixing parts									
3TK10	4 moving and 8 fixed contacts		D	3TK19 60-0A		1	1 unit	101	0.270
3TK11		D	3TK19 61-0A		1	1 unit	101	0.270	
3TK12		D	3TK19 62-0A		1	1 unit	101	0.580	
3TK13		D	3TK19 63-0A		1	1 unit	101	0.580	
3TK14		D	3TK19 64-0A		1	1 unit	101	2.400	
3TK15		D	3TK19 65-0A		1	1 unit	101	2.400	
3TK17		D	3TK19 67-0A		1	1 unit	101	2.400	

For rated control supply voltages for solenoid coils, see page 3/131.

Accessories and Spare Parts

For 3T Contactors and Contactor Relays

Spare parts for 3TB, 3TC, 3TF, 3TK contactors

Rated control supply voltages (the 10th and 11th position of the order number must be changed)

For contactor type	3TC44	3TC48	3TC5	3TF68/69	3TK10/11/12/13	3TK14/15/17
Solenoid coil type	3TY7 403-0A..	3TY6 483-0A..	3TY6 523-0A.. 3TY6 566-0A..	3TY7 683-0C.. 3TY7 693-0C..	3TK19 70-0A.. 3TK19 72-0A..	3TK19 74-0A..
Rated control supply voltage U_s						

AC operation

Solenoid coils for 50 Hz

24 V AC	B0	B0	--	--	B0 ³⁾	--
110 V AC	F0	F0	F0	--	F0 ³⁾	F0 ³⁾
230/220 V AC	P0 ¹⁾	P0 ¹⁾	P0 ¹⁾	--	P0 ³⁾	P0 ³⁾
240 V AC	U0	U0	--	--	U0 ³⁾	U0 ³⁾

AC operation

Solenoid coils for 50/60 Hz

24 V AC	C2	--	--	--	--	--
110 V AC	G2	--	--	--	--	--
120 V AC	K2	--	--	--	--	--
220 V AC	N2	--	--	--	--	--
230 V AC	L2	--	--	--	--	--
110 V ... 132 V AC	--	--	--	F7	--	--
200 V ... 240 V AC	--	--	--	M7	--	--
230 V ... 277 V AC	--	--	--	P7 ²⁾	--	--
380 V ... 460 V AC	--	--	--	Q7	--	--
500 V ... 600 V AC	--	--	--	S7	--	--

For contactor type	3TC4	3TB5, 3TC5	3TF68/69
Solenoid coil type	3TY6 443-0B.. 3TY6 483-0B..	3TY6 503-0B.. 3TY6 523-0B.. 3TY6 543-0B.. 3TY6 563-0B..	3TY7 683-0D.. 3TY7 693-0D..
Rated control supply voltage U_s			

DC operation

24 V DC	B4	B4	B4
48 V DC	W4	--	--
60 V DC	E4	--	--
110 V DC	F4	F4	F4
125 V DC	G4	--	G4
220 V DC	M4	M4	M4
230 V DC	P4	--	P4

- ¹⁾ Operating range at 220 V or 380 V:
0.85 to 1.15 x U_s ;
lower operating range limit according to IEC 60947.
- ²⁾ Lower operating range limit at 220 V:
0.85 x U_s according to IEC 60947.
- ³⁾ Rated control supply voltages U_s :
- | | | |
|------------|----------------|-----------------------|
| | 50 Hz | 60 Hz |
| B0: | 24 V | -- |
| F0: | 110 V | 120 V |
| P0: | 220 V to 230 V | 240 V (only 3TK1 974) |
| U0: | 230 V to 240 V | -- |

Accessories and Spare Parts

Notes

